

# GL980

**midi LOGGER**

## **USER'S MANUAL**

---

MANUAL NO.GL980-UM-151

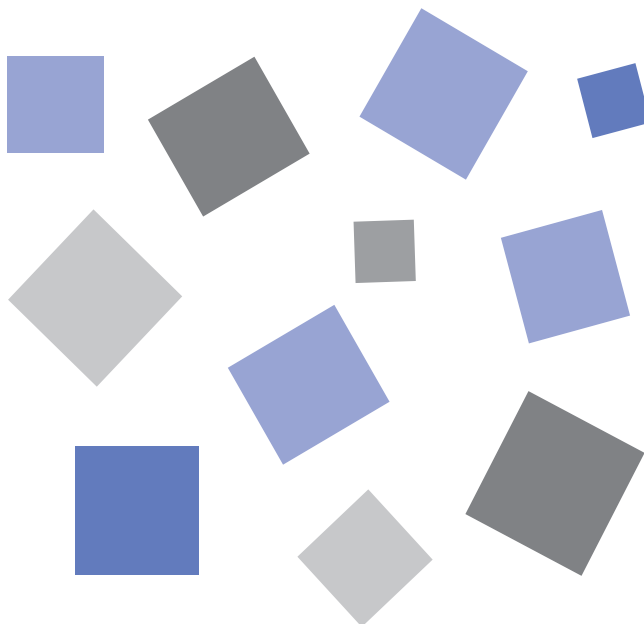

# GRAPHTEC







## To Ensure Safe and Correct Use









- To ensure safe and correct use of this device, read this manual thoroughly before use.
- After having read this manual, keep it in a handy location for quick reference as needed.
- Do not permit small children to touch this device.
- The following describes important points for safe operation. Please be sure to observe them strictly.

### Conventions Used in This Manual

To promote safe and accurate use of this device as well as to prevent human injury and property damage, safety precautions provided in this manual are ranked into the five categories described below. Be sure you understand the difference between each of the categories.

 <b>DANGER</b>	This category provides information that, if ignored, is highly likely to cause fatal or serious injury to the operator.
 <b>WARNING</b>	This category provides information that, if ignored, is likely to cause fatal or serious injury to the operator.
 <b>CAUTION</b>	This category provides information that, if ignored, could cause physical damage to this device.
 <b>HIGH TEMPERATURE</b>	This category provides information that, if ignored, is likely to cause burns or other injury to the operator due to contact with high temperature.
 <b>ELECTRICAL SHOCK</b>	This category provides information that, if ignored, is likely to expose the operator to electrical shock.

### Description of Safety Symbols

	The  symbol indicates information that requires careful attention (including warnings). The specific point requiring attention is described by an illustration or text within or next to the  symbol.
	The  symbol indicates an action that is prohibited. Such prohibited action is described by an illustration or text within or next to the  symbol.
	The  symbol indicates an action that must be performed. Such imperative action is described by an illustration or text within or next to the  symbol.





# Introduction

Thank you for purchasing the GL980 midi LOGGER.

Please read this manual thoroughly before attempting to use your new product to ensure that you use it correctly and to its full potential.

## Notes on Use

Be sure to read all of the following notes before attempting to use the GL980 midi LOGGER.

### 1. Note on the CE Marking

The GL980 midi LOGGER complies with the following standards.

- EN 61326-1 Class A standard based on the EMC directive (2014/30/EU)
- EN 61010-1:2010 3rd standard based on the LVD directive (2014/35/ EU)

Although the GL980 complies with the above-mentioned standards, be sure to use it correctly in accordance with the instructions and notes provided in this manual.

Moreover, use of the GL980 by incorrect procedures may result in damage to the GL980 or may invalidate its safeguards. Please confirm all of its notes regarding use and other related information to ensure correct use.

### 2. Warning

This is a Class A product according to the EMC directive. In a domestic environment, this product may cause radio interference or may be affected by radio interference to the extent that proper measurement cannot be performed.

### 3. Notes for Safe Operation

- (1) Be sure to use the Graphtec-supplied AC adapter. In environments where there is a lot of noise or where the power supply is unstable, we recommend that you ground the GL980.
- (2) When a high-voltage signal cable has been connected to the main unit's analog signal input terminal, avoid touching the leads of the input terminal's signal cable to prevent electrical shock due to high voltage.
- (3) Ensure that the GL980 power source is positioned so that it can easily be disconnected.
- (4) Do not input the voltage that is exceeding the specification of this device.
  - If a voltage exceeding the specified value is input, the semiconductor relay in the input section will be damaged. Never input a voltage exceeding the specified value even for a moment. It will cause the fire.
  - Have an enough margin from the specification of withstanding voltage when using this device, it have to consider a noise and change of the measurement voltage.
  - Confirm this device is not broken before the input cable is connected to the input terminal.
  - Please take care of the static electricity when the connecting the input cables or the thermocouples.
  - Do not touch the tip of thermocouples with bare hand after the thermocouples are connected to the terminal of this device when the tip of thermocouples is not insulated.  
The static electricity of a human body will cause damage to this device.
  - Do not put the tip of thermocouples to the object which is containing the static electricity when the tip of thermocouples is not insulated. The static electricity of object will cause damage to this device.
  - Do not put the tip of thermocouples to the object which is containing the leaked high voltage of chassis or metal etc. when the tip of thermocouples is not insulated.  
The leaked high voltage of object will cause damage to this device.
  - We recommend that the insulation tape puts on the tip of thermocouples before connecting the thermocouples to the input terminals.

## **Introduction**

This will protect this device from the static electricity and the leaked high voltage.

### **4. Notes on Functions and Performance**

- (1) Be sure to connect the main unit to an AC or DC power supply that conforms to the rated range. Connection to a non-rated power supply may cause the main unit to overheat and break down.
- (2) Do not block the vent on the main unit. Continued operation with the vent blocked may cause the main unit to overheat and break down.
- (3) To avoid malfunctions and other damage, avoid using the GL980 in the following locations.
  - Places exposed to high temperature and/or high humidity, such as in direct sunlight or near heating equipment.  
(Allowable temperature range: 0 to 45°C (When a battery pack is mounted, When battery is being charged), Allowable humidity range: 5 to 85%R.H., non-condensing)
  - Locations subject to excessive salt spray or heavy fumes from corrosive gas or solvents.
  - Excessively dusty locations.
  - Locations subject to strong vibrations or shock.
  - Locations subject to surge voltages and/or electromagnetic interference.
- (4) If the main unit becomes soiled, wipe it off using a soft, dry cloth. Use of organic solvents (such as thinner or benzene) causes deterioration and discoloration of the outer casing.
- (5) Do not use the GL980 in the vicinity of other devices which are susceptible to electromagnetic interference.
- (6) Measured results may not conform to the stated specifications if the GL980 is used in an environment which is subject to strong electromagnetic interference.
- (7) Insofar as possible, position the GL980 input signal cables away from any other cables which are likely to be affected by electromagnetic interference.
- (8) For stabilized measurement, allow the GL980 to warm up for at least 30 minutes after turning it on.

### **Notes on the Use of This Manual**

- (1) All rights reserved. No part of this publication may be reproduced, stored in a retrieval system, or transmitted, in any form or by any means, without the prior written permission of Graphtec Corporation.
- (2) The specifications and other information in this manual are subject to change without notice.
- (3) While every effort has been made to supply complete and accurate information about this product, please address any inquiries about unclear information, possible errors, or other comments to your sales representative or nearest Graphtec vendor.
- (4) Notwithstanding the preceding paragraph, Graphtec Corporation assumes no liability for damages resulting from the use of the information contained herein or of the product.

### **About Registered Trademarks**

Microsoft and Windows are registered trademarks or trademarks of Microsoft Corporation in the U.S. and elsewhere.

Other company names and product names included in this manual are registered trademarks or trademarks of their respective companies.

### **Copyright**

All copyrights regarding this manual belong to Graphtec Corporation.



# CONTENTS

<b>To Ensure Safe and Correct Use</b> .....	<b>i</b>
<b>Introduction</b> .....	<b>1</b>
Notes on Use .....	<b>1</b>
Notes on the Use of This Manual .....	<b>III</b>
About Registered Trademarks .....	<b>III</b>
Copyright .....	<b>III</b>

## CHAPTER 1 General Description

<b>1.1 Overview</b> .....	<b>1-2</b>
<b>1.2 Features</b> .....	<b>1-2</b>
<b>1.3 Operating Environment</b> .....	<b>1-3</b>
Ambient Operating Conditions .....	<b>1-3</b>
Warming-up Before Use .....	<b>1-3</b>
Configuration When in Use .....	<b>1-4</b>
<b>1.4 Rubber Protector of This Device</b> .....	<b>1-5</b>
<b>1.5 Notes on Temperature Measurement</b> .....	<b>1-6</b>
<b>1.6 Notes on Using the Monitor</b> .....	<b>1-6</b>
<b>1.7 Changing the Display Language</b> .....	<b>1-6</b>

## CHAPTER 2 Checks and Preparation

<b>2.1 Checking the Outer Casing</b> .....	<b>2-2</b>
<b>2.2 Checking the Accessories</b> .....	<b>2-2</b>
<b>2.3 Nomenclature and Functions</b> .....	<b>2-3</b>
<b>2.4 How to attach the tilt stand</b> .....	<b>2-4</b>
<b>2.5 How to attach and detach the rubber protector</b> .....	<b>2-5</b>
How to attach the rubber protector .....	<b>2-5</b>
How to detach the rubber protector .....	<b>2-6</b>
<b>2.6 Connecting the Power Cable and Turning on the Power</b> .....	<b>2-7</b>
<b>2.7 Connecting the Signal Input Cables</b> .....	<b>2-9</b>
<b>2.8 Logic Alarm Cable Connection and Functions</b> .....	<b>2-11</b>
<b>2.9 Mounting the SD Card</b> .....	<b>2-14</b>
<b>2.10 Installing USB Memory</b> .....	<b>2-16</b>
<b>2.11 Connecting to a PC</b> .....	<b>2-17</b>
<b>2.12 Using the Battery Pack (B-569 : Option)</b> .....	<b>2-19</b>
<b>2.13 Connecting the Humidity Sensor</b> .....	<b>2-22</b>
<b>2.14 Precautions to Observe When Performing Measurement</b> .....	<b>2-23</b>
<b>2.15 Noise Countermeasures</b> .....	<b>2-25</b>
<b>2.16 When Fixing This Device</b> .....	<b>2-26</b>
<b>2.17 Setting the Date and Time</b> .....	<b>2-27</b>

## CHAPTER 3 Settings and Measurement

<b>3.1</b>	<b>Window names and functions</b> .....	<b>3-2</b>
<b>3.2</b>	<b>Key Operation</b> .....	<b>3-17</b>
<b>3.3</b>	<b>Description of the display mode</b> .....	<b>3-27</b>
	(1) Y-T waveform display .....	3-27
	(2) Logging display/real time statistical calculation display .....	3-37
	(3) XY waveform display .....	3-39
<b>3.4</b>	<b>Operation Modes</b> .....	<b>3-51</b>
<b>3.5</b>	<b>Setting Menus</b> .....	<b>3-55</b>
	(1) AMP settings .....	3-55
	(2) DATA settings .....	3-69
	(3) DISP settings .....	3-82
	(4) TRIG settings .....	3-93
	(5) Interface settings .....	3-103
	(6) OTHER settings .....	3-110
	(7) FILE menu .....	3-116
	(8) Data replay menu .....	3-128
<b>3.6</b>	<b>WEB Server Function</b> .....	<b>3-132</b>
<b>3.6</b>	<b>List of Error Codes</b> .....	<b>3-137</b>

## CHAPTER 4 Specification

<b>4.1</b>	<b>Standard Specifications</b> .....	<b>4-2</b>
	Internal RAM .....	4-3
	Internal Flash memory .....	4-3
	USB Memory slot .....	4-3
	SD card .....	4-3
	PC I/F .....	4-4
	Monitor .....	4-4
	Input section .....	4-5
<b>4.2</b>	<b>Function Specifications</b> .....	<b>4-7</b>
	Trigger Functions .....	4-8
	Alarm Functions .....	4-8
	External Input/Output Functions .....	4-9
<b>4.3</b>	<b>Accessories/Optional Accessories</b> .....	<b>4-10</b>
	Control Software .....	4-10
	List of Options .....	4-11
<b>4.4</b>	<b>External Dimensions</b> .....	<b>4-12</b>

<b>INDEX</b> .....	<b>I-1</b>
--------------------	------------

# ***CHAPTER 1 General Description***

---

This chapter provides a general description of this device and its features.

## **PRODUCT SUMMARY**

- 1.1 Overview***
- 1.2 Features***
- 1.3 Operating Environment***
- 1.4 Rubber Protector of This Device***
- 1.5 Notes on Temperature Measurement***
- 1.6 Notes on Using the Monitor***
- 1.7 Changing the Display Language***

## 1.1 Overview

The GL980 is a compact, lightweight, multi-CH, and multi-purpose data logger with a 7-inch color display. The GL980 can capture up to  $\pm 500V$  with the fastest 1  $\mu s$  sampling.

Measured data of large capacity can be saved directly in the built-in memory, SD card, or USB memory.

Since the PC interface is equipped with USB and Ethernet, the system configuration according to the application becomes possible. The system can be configured according to the application. Since it is equipped with WEB server and FTP server function as Ethernet function, you can monitor and transfer data remotely.

## 1.2 Features

### Input

- Using M3.5 screw terminal or BNC terminal, input terminal can be easily wired.
- Voltage, temperature, effective value (RMS) can be measured.

### Display & Operation

- With this device's high-resolution 7-inch TFT color liquid crystal display, you can confirm the waveforms of measured data and each channel's settings at a glance.
- Easy operation is achieved through a straightforward menu structure and key allocation which resembles mobile phones.

### Data Capture

- This device can capture to the internal RAM at up to 1  $\mu s$  capturing interval.
- You can measure for a long time at high speed because that the internal RAM has 4M word per CH. In addition, it is very convenient when repeating measurement because that the internal RAM can be divided into up to 8.
- It is possible to capture up to 4GByte data to the internal memory, SD memory card and USB memory.
- Measured data of large capacity can be saved directly in the built-in memory, SD card, or USB memory.
- Since SD card or USB memory can be attached as external memory, you can measure at ease for a long time while backing up data.
- The new ring memory capture function maintains latest data even after capturing for a long term. (You need to set how long you want to keep data.)
- The GL980 is equipped with the relay capturing function, and 4GByte or more data can be saved by switching the to the other file without data missing.

### Data Control & Processing

- The application software provided lets you set conditions and monitor data on a PC.
- With the USB drive mode function, you can recognize the GL980 internal memory and SD card as an external drive from the PC.  
(Connect the GL980 to the PC and turn on the GL980 power while holding down the [START] key.)
- The WEB server function enables control and monitoring from a remote location without using dedicated software
- The NTP client function enables synchronization of the time with the NTP server.



## 1.3 Operating Environment

This section explains the operating environment for this device.

### Ambient Operating Conditions

- (1) Ambient temperature and humidity (Use within the following range.)
  - Temperature range: 0 to 40°C (When AC adapter or battery is operated)
  - Humidity range: 5 to 85% R.H. (non-condensing)
- (2) Environment (Do not use in the following locations.)
  - A Location such as being exposed to direct sunlight
  - Locations exposed to salty air, corrosive gases, or organic solvents
  - Dusty locations
  - Locations subject to vibration or impact
  - Locations subject to voltage surge or electromagnetic interference such as lightning or electric furnaces
- (3) Installation category (over-voltage category)
  - This device belongs to Installation Category II defined in IEC60664-1.
  - Never use this device for Installation Category III or IV.
- (4) Measurement category
  - This device is not available for Measurement category II, III and IV.



• **If condensation occurs...**

**Condensation occurs in the form of water droplets on the device surfaces and interior when this device is moved from a cold to a warm location. Using this device with condensation will cause malfunctioning. Wait until the condensation has disappeared before turning on the power.**

---

### Warming-up Before Use

This device should be allowed to warm up with the power turned on for approximately 30 minutes to ensure that it operates according to the specified performance.

## Configuration When in Use

When using this device, be sure to set it vertically, or use the tilt foot and tilt stand to operate this device.

<Usage Configuration>

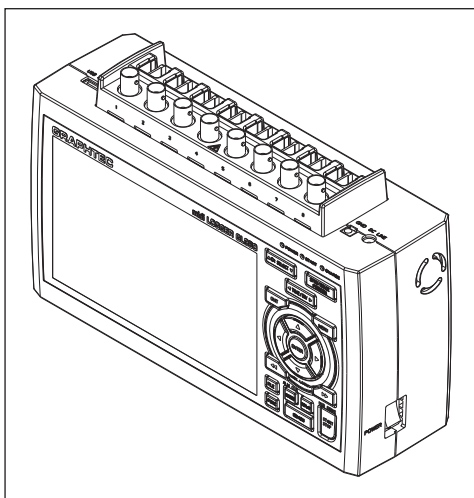

Vertical state

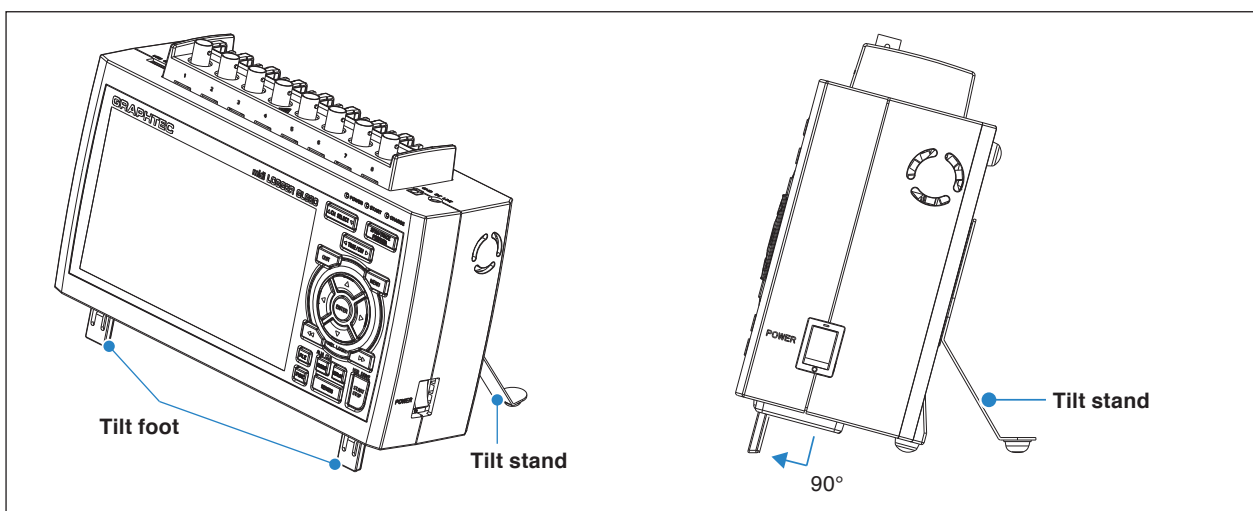

Inclined state

### **⚠ CAUTION**

- Do not block the air vent on this device, as this will cause malfunctioning.
- Measurement accuracy may not be satisfactory if the system is used in a condition other than described above.
- If using this device in a tilted state, there is a possibility that the device will fall down. Please use both tilt foot and tilt stand for this device.

## 1.4 Rubber Protector of This Device

To remove the battery pack, remove rubber protector.

This manual describes in the state that rubber protector is not mounted.

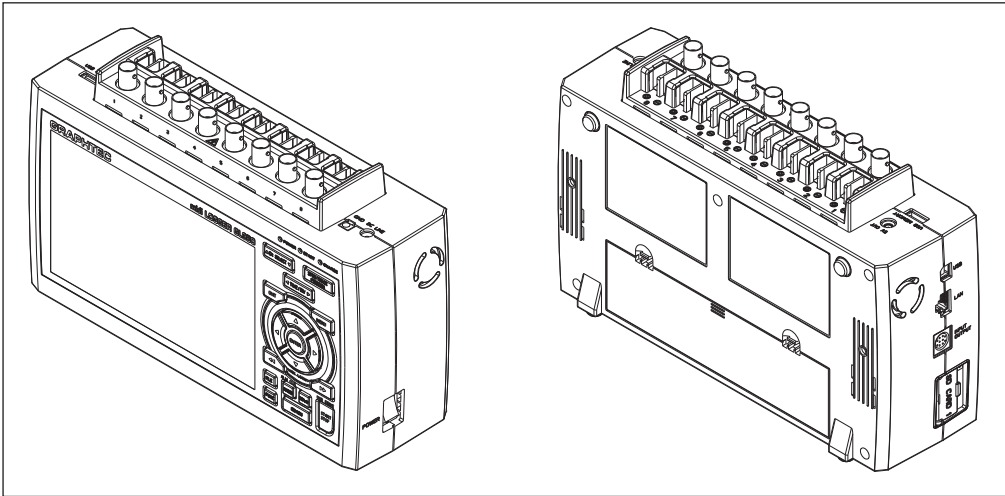

When the rubber protector is not mounted

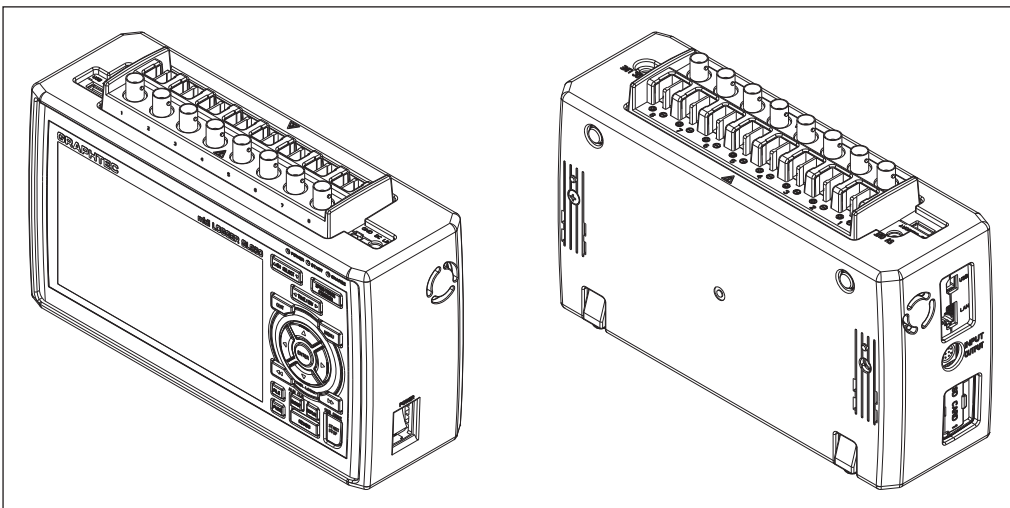

When the rubber protector is mounted

## 1.5 Notes on Temperature Measurement

Please observe the following precautions when performing temperature measurement.

- Do not block the air vents. Always provide a space of at least 30 cm on all sides of this device.
- For stabilized temperature measurement, allow this device to warm up for at least 30 minutes after turning it on.
- Exposure of the input terminals to direct drafts, direct sunlight, or abrupt changes in temperature may impair the equilibrium of the input parts and result in measurement errors. To measure temperature in such an environment, take appropriate countermeasures such as changing the installation site of this device.
- To conduct measurement in noisy environments, connect this device's GND terminal to ground (Refer to "2.15 Noise Countermeasures").
- If the measured value fluctuates due to noise, set FILTER to other than OFF in the input setting menu of this device.

## 1.6 Notes on Using the Monitor

The monitor is an LCD display unit, and so the display will vary depending on the operating environment.

### CHECKPOINT

If the screen saver function is used, it will operate and clear the screen if no operations are performed during the preset time. When pressing any of the operation keys, the screen saver is released and the screen display is started.

### CAUTION

- Condensation may form on the LCD screen if this device is moved from a cold to a warm location. If this occurs, wait until the LCD screen warms up to room temperature.
- The LCD screen is manufactured to extremely high precision. Black dots may appear, or red, blue, and green dots may not disappear. Likewise, streaks may appear when viewed from certain angles. These phenomena are due to the LCD screen construction, and are not signs of a fault.

## 1.7 Changing the Display Language

You can choose the language displayed on the screen. The default display language is set to English when this device is shipped overseas. To change the display language, see the instructions in "OTHER:Language".



# CHAPTER 2 Checks and Preparation

---

This chapter provides how to check the device's external casing and accessories, and how to prepare the device for operation.

## PRODUCT SUMMARY

- 2.1 *Checking the Outer Casing*
- 2.2 *Checking the Accessories*
- 2.3 *Nomenclature and Functions*
- 2.4 *How to attach the tilt stand*
- 2.5 *How to attach and detach the rubber protector*
- 2.6 *Connecting the Power Cable and Turning on the Power*
- 2.7 *Connecting the Signal Input Cables*
- 2.8 *Logic Alarm Cable Connection and Functions*
- 2.9 *Mounting the SD Card*
- 2.10 *Installing USB Memory*
- 2.11 *Connecting to a PC*
- 2.12 *Using the Battery Pack (B-569 : Option)*
- 2.13 *Connecting the Humidity Sensor*
- 2.14 *Precautions to Observe When Performing Measurement*
- 2.15 *Noise Countermeasures*
- 2.16 *When Fixing This Device*
- 2.17 *Setting the Date and Time*

## 2.1 Checking the Outer Casing

After unpacking, check this device's outer casing before use. In particular, please check for the following:

- Surface scratches
- Other flaws such as stains or dirt

## 2.2 Checking the Accessories

After unpacking, check that the following standard accessories are included.

### Standard Accessories

Item	Remarks	Quantity
Quick Start Guide	GL980-UM-85x	1
CD-ROM	User's Manual, Application software	1
TO ENSURE SAFE AND CORRECT USE		1
AC cable/AC adapter	100 to 240 VAC, 50/60 Hz	1
Ferrite core	For attaching each cable	4
M3.5 Flat screw	For thin-type thermocouple	20
Tilt stand	Tilt stand x2, M4 screw x2, Spacer x3	1

## 2.3 Nomenclature and Functions

This section describes the names and function of parts of this device.

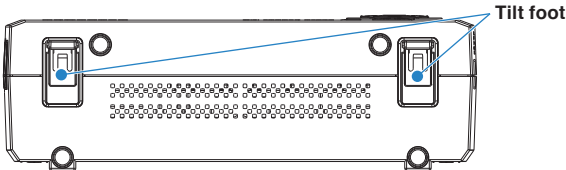
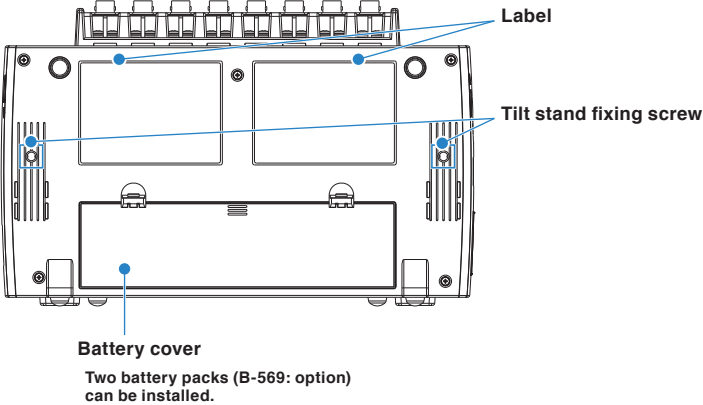
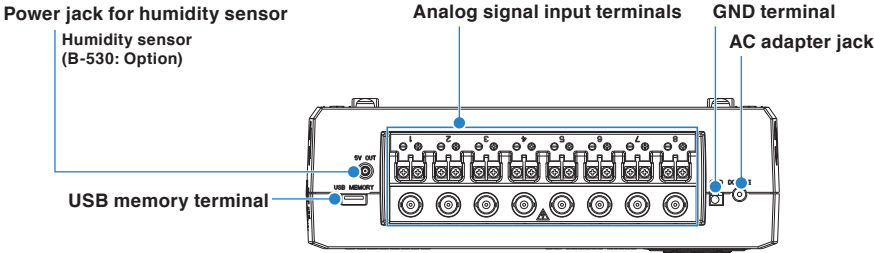
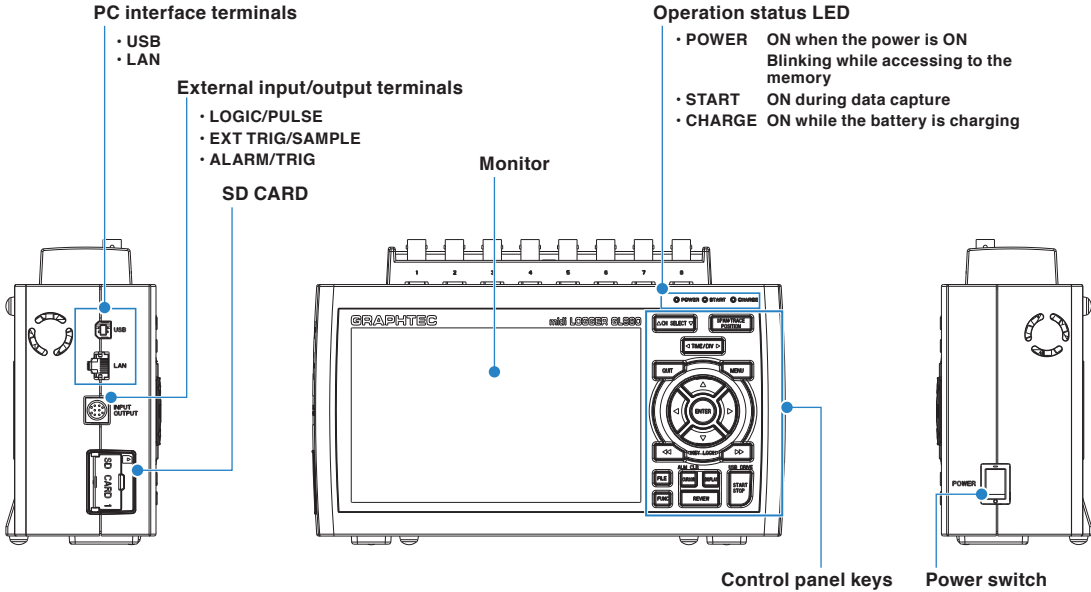

## 2.4 How to attach the tilt stand

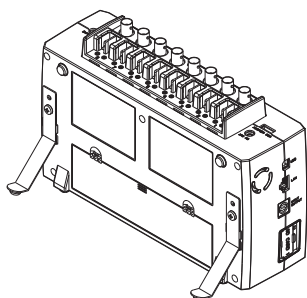

When tilt foot is used

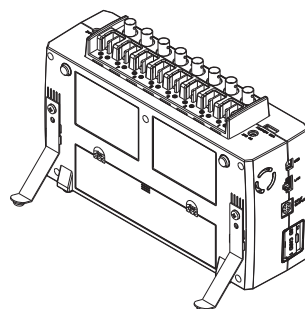
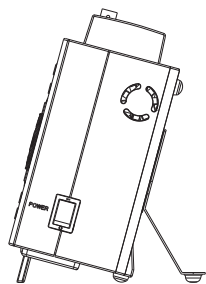

When tilt foot is not used

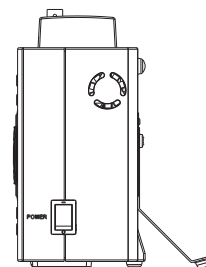

(1) Please pay attention to the mounting position and install the tilt foot.

- When the Rubber Protector is not used

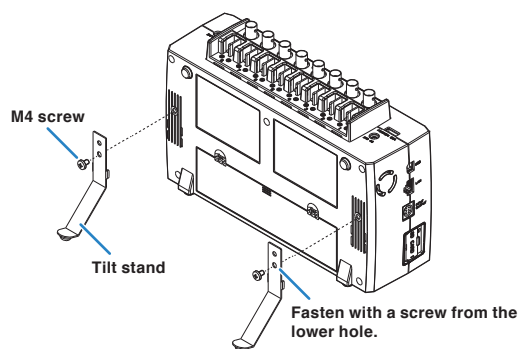

When tilt foot is used

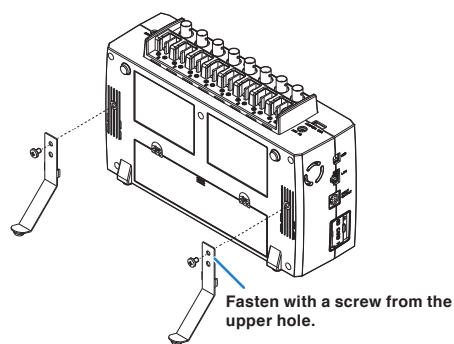

When tilt foot is not used

- When the Rubber Protector is used

Fix the tilt stand using a spacer as shown below.

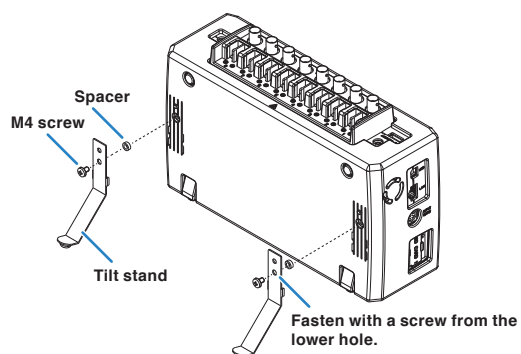

When tilt foot is used

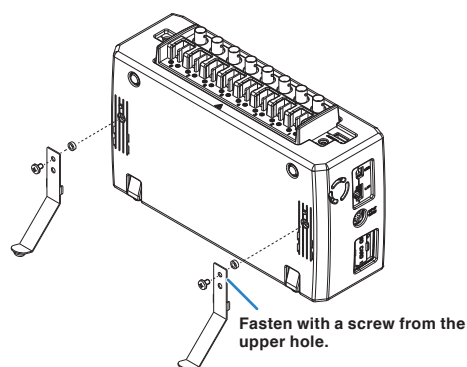

When tilt foot is not used

### CAUTION

- To prevent possible malfunction, do not block the air vents of this device.
- If you use this device in other position than described in the above, the measurement accuracy may not meet the specifications.
- To prevent possible falling, attach both the supplied the tilt stand and tilt foot for this device.



## 2.5 How to attach and detach the rubber protectorr

### How to attach the rubber protectorr

#### CAUTION

To remove the battery pack, first remove rubber protector.

- (1) Insert one side of this device about half into the Rubber Protector.

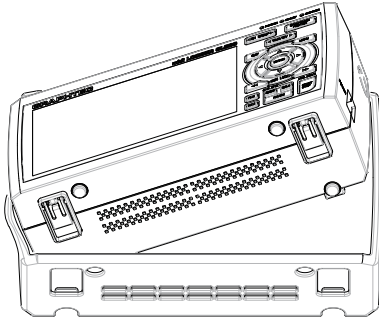

- (2) While inserting the terminal block part, insert about the remaining half.

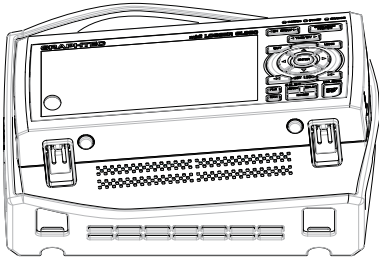

- (3) Adjust so that the rubber protector is not out of position.

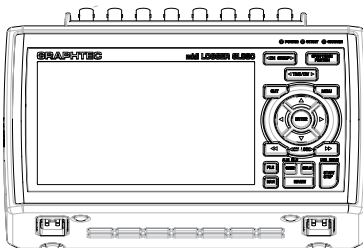

- (4) Make sure that corners and convexities are properly fitted and adjust the rubber protector so that there is no gap.

How to detach the rubber protectorr

- (1) Open the upper and lower corner of the Rubber Protector on one side of this device as shown below.
- (2) Push out the body from the back side.

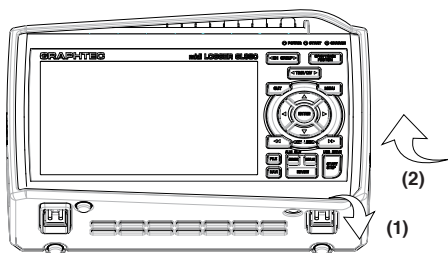

- (3) When both corners of this device are removed from the Rubber Protector, remove the terminal block part.

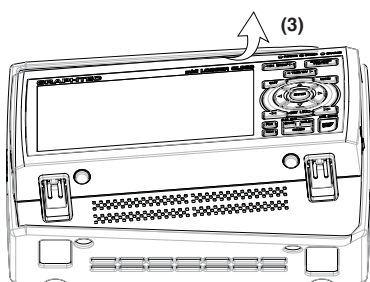

- (4) Remove the body completely from the Rubber Protector.

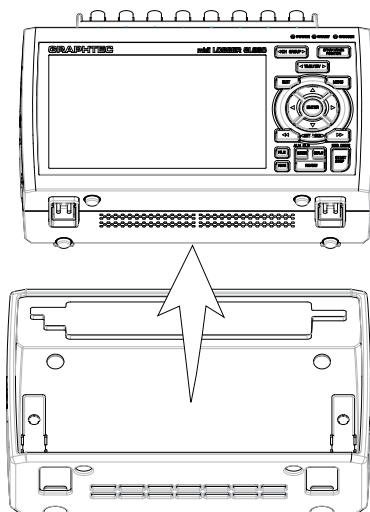

## 2.6 Connecting the Power Cable and Turning on the Power

This section describes how to connect the power cable and turn on the power. The connection method will vary depending on the type of power supply used.

### Connecting to an AC Power Supply

Use the AC cable and AC adapter that are provided as accessories.

#### CAUTION

Be sure to use the AC adapter that is supplied as a standard accessory.

- (1) Plug the AC cable into the AC adapter.

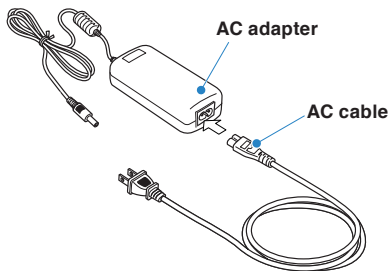

- (2) Connect the output side of the AC adapter to the connector on this device.

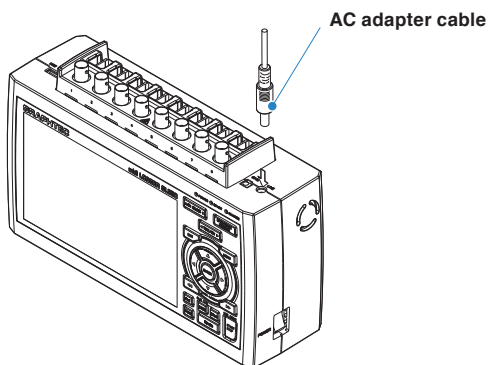

- (3) Using the flat-blade screwdriver, press against the minus (-) button above the GND terminal, while connecting the grounding cable to this device. Connect the other end of the cable to ground.

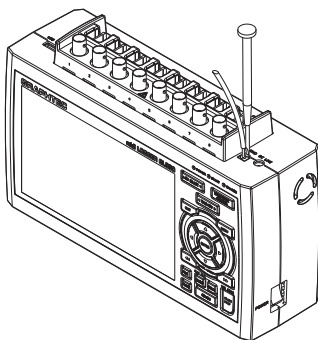

- (4) Plug the AC cable into the mains power outlet.
- (5) Press the power switch on this device to the ON side to turn on the power.

#### CAUTION

Always connect the GND terminal and refer to the TO ENSURE SAFE AND CORRECT USE precautions. This device must be grounded even when connected to other devices and sharing a common ground level.

## Connecting to a DC Power Supply

Use the DC drive cable (B-514: option).

---

### **⚠ CAUTION**

- Use a power supply within the 8.5 to 26.4 VDC range.
  - For DC drive cable, please be sure to use the B-514.
- 

- (1) Configure the tip of the DC drive cable (B-514: 2m) to enable it to be connected to the DC power supply.
- (2) Connect the DC output side to the power supply connector on this device.

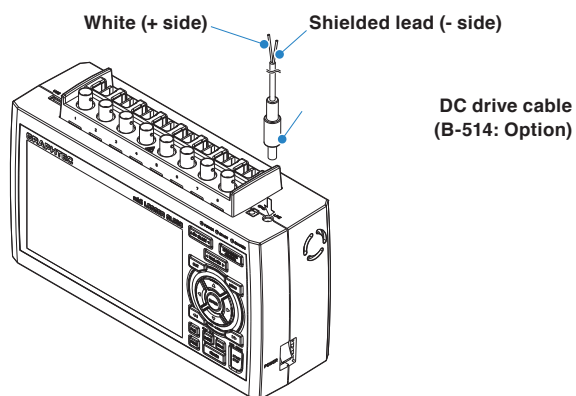

- (3) Connect the DC input side to the DC power supply.

---

### **⚠ CAUTION**

**Be sure to check the polarity of the wire tips when performing wiring.**

---

- (4) Press the power switch on this device to the ON side to turn on the power.

## 2.7 Connecting the Signal Input Cables

This section describes how to connect the signal input cables.

**WARNING**

When wiring, check that the signal supply source is OFF to prevent electric shock. Also, position this device input cable away from any power lines and ground cables.

### Terminal Configuration and Signal Types

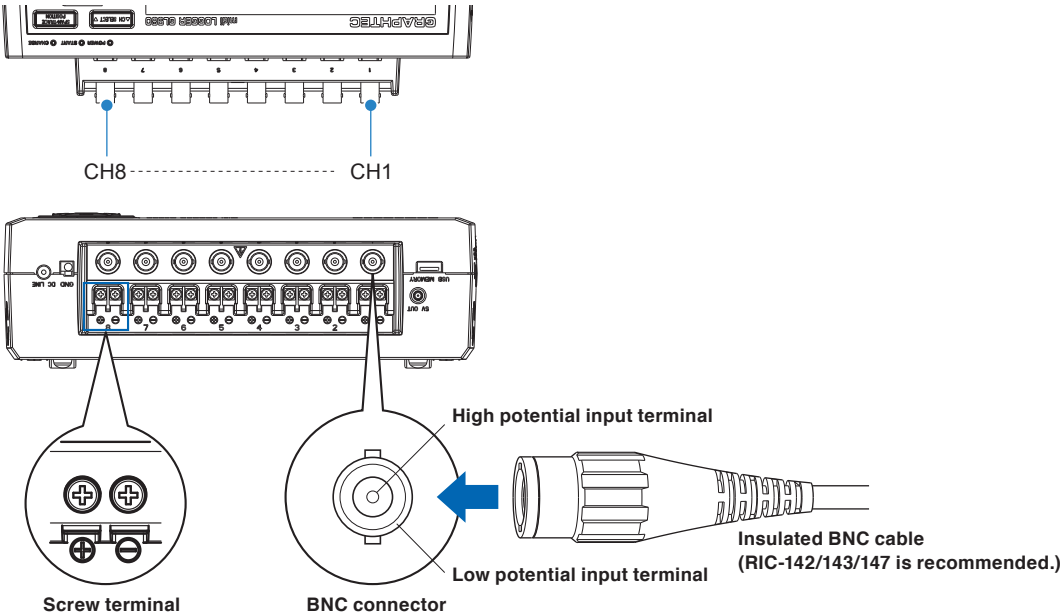

The screw terminal and the BNC connector are internally connected. You can measure with either input.

**WARNING**

When wiring, check that the signal supply source is OFF to prevent electric shock. Also, wire as far as possible from the power line and ground cable.

The screw terminals of the same CH and the BNC connector are connected.

Do not input signals to the screw terminal and BNC connector of the same CH at the same time.

If a signal is input at the same time, the measurement target device may be damaged.

When wiring, check that the signal supply source is OFF to prevent electric shock. When applying a voltage of 60V or more, please use an insulated BNC cable (RIC-142/143/147: Option) sold separately to prevent electric shock.

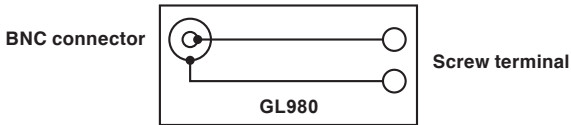

## Connection diagram

DC voltage input

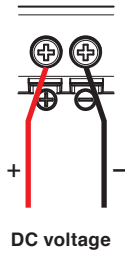

DC voltage

Thermocouple input

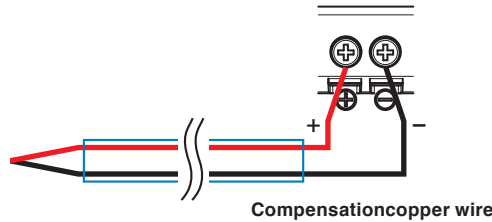

Compensation copper wire

Current input

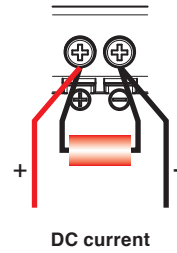

DC current

Ex: The current is converted to the voltage in the shunt register.  
For 4 to 20mA current input, installing 250 ohms (0.1%) resistor for converting 1 to 5V.

### CAUTION

Please wire so that the main unit is not pulled by the signal input cable.  
If the main unit is pulled, there is a danger that it will fall down.

- + .....High potential terminal (The high potential side of the input signal is input.)
- .....Low potential terminal (The low potential side of the input signal is input.)

Item	Description
Input configuration	Isolated input
Measurement range	20, 50, 100, 200, 500 mV/F.S.; 1, 2, 5, 10, 20, 50, 100, 200, 500V/F.S. 1-5V/F.S
Thermocouples	K, J, E, T, R, S, B, N, W (WRe 5-26)
A/D resolution	16-bit (Effective resolution: Approx. 1/40,000 of $\pm$ range)
Filter	Off, Line, 5, 50, 500, 5k, 50 kHz

## Input cable

This device conforms to the EMC directive when the core is attached to the input cable.  
Please attach the supplied core to the input cable as shown in the figure below.

\* Even without a core, measurement accuracy is not affected.

When installing more than one (3 to 4 pcs.) at the same time

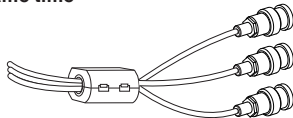

When installing to 1 or 2



In case of thermocouple



## Screw terminal

Recommended tightening torque of screw terminal is max. 6kgf/cm.

If the thermocouple tends to be come off due to the use of a thin-type thermocouple, replace it with the supplied flat screw.

## 2.8 Logic Alarm Cable Connection and Functions

This section describes how to connect the logic alarm cables and the functions of cable.

**WARNING**

When wiring, check that the signal supply source is OFF to prevent electric shock. Also, position this device input cable away from any power lines and ground cables.

The Input/output cable for GL (B-513: Option) enables logic/pulse input, external trigger input, and alarm/trigger signal output.

Connect the Input/output cable for GL (B-513: Option) to the external input/output terminal as shown below.

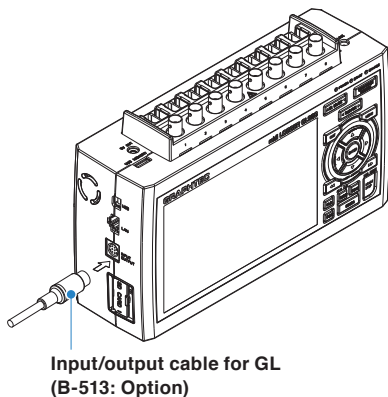

### Logic/Pulse Input Specifications

Item	Description
Number of input channels	4
Input voltage range	0 to +30 V max. (single-ended ground input)
Threshold level	Approx. +2.5 V
Hysteresis	Approx. 0.5 V (+2.5 to +3 V)

\* Switch between logic and pulse input.

### Trigger Input/External Sampling Input Specifications

Item	Description
Number of input channels	1
Input voltage range	0 to +30 V max. (single-ended ground input)
Threshold level	Approx. +1.9 V
Hysteresis	Approx. 0.2 V (+1.9 to + 2.1 V)

### Alarm Output Specifications

Item	Description
Number of Output channels	4 Output 1 is used for alarm output and trigger output by switching.
Output format	Open collector output +5 V, 10 KΩ pull-up resistance * For details of alarm output, refer to the next page.
Trigger output time	When a start trigger or a stop trigger is detected, a pulse of approx.500 μs width is output from the output 1 terminal. (When setting low active and trigger output) * When a stop trigger is issued within 1 ms from the start trigger, the trigger is output at an interval of approx.1 ms.

**CAUTION**

When the power is turned OFF or ON, this device temporarily becomes the alarm state.

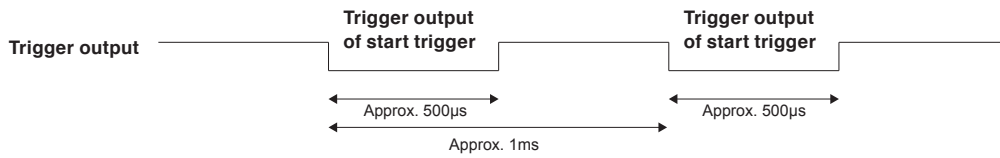

### Internal equivalent circuit of I/O circuit

#### ● Alarm output

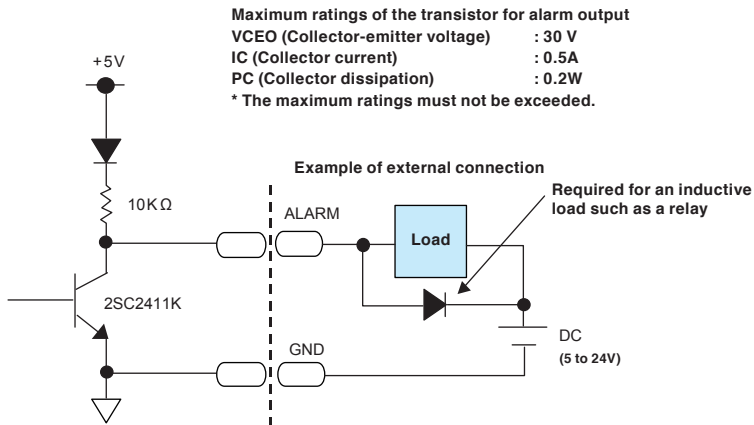

#### ● Logic/pulse input

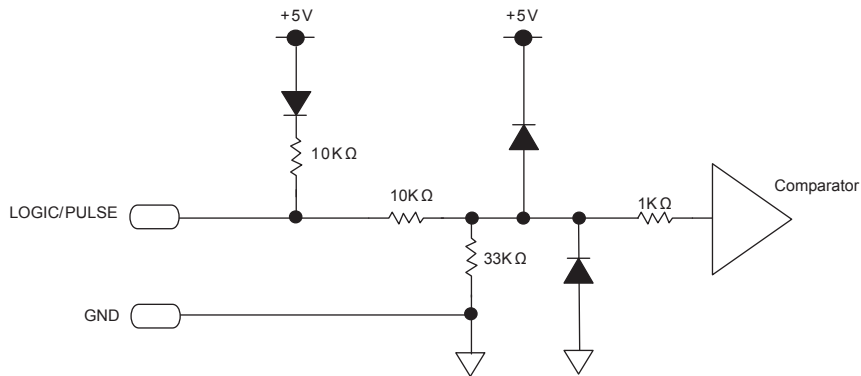

#### ● Trigger input/external sampling input

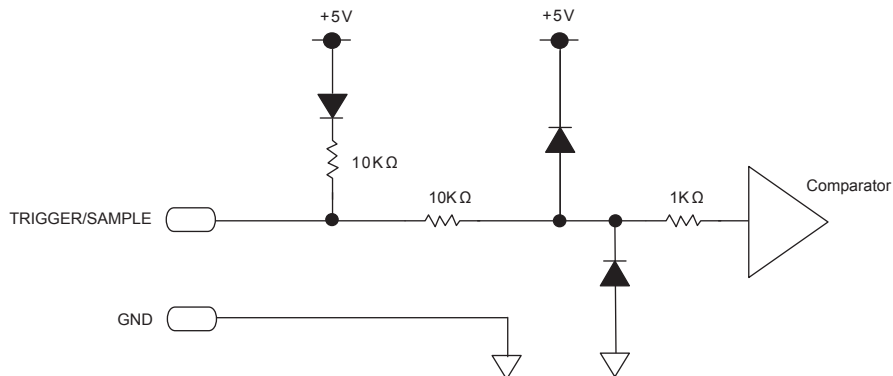



**Wiring**

Cable tips are bare tips. Perform wiring for the necessary functions.

Signal Name	Channel Number	Wire Color
Logic/Pulse input	1	Orange with red dotted line
	2	Orange with black dotted line
	3	Grey with red dotted line
	4	Grey with black dotted line
Output1 : Alarm output1 / Trigger output *		White with red dotted line
Output2 : Alarm output2		White with black dotted line
Output3 : Alarm output3		Yellow with red dotted line
Output4 : Alarm output4		Yellow with black dotted
Trigger input/External sampling input		Pink with red dotted line
GND		Pink with black dotted line
		Shielded

- \* Switch between logic and pulse.
- \* Output 1 is used for alarm output and trigger output by switching.

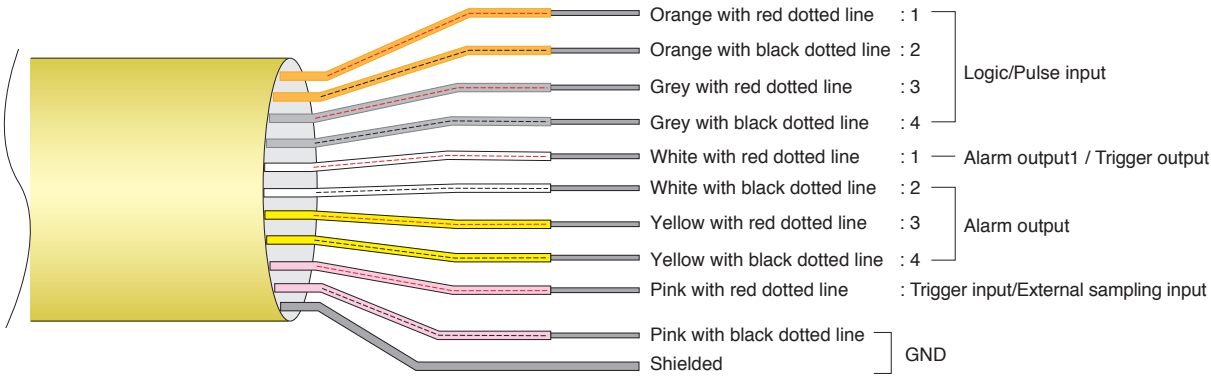

## 2.9 Mounting the SD Card

### CAUTION

- When the SD card is inserted, make sure that the card is not locked. If locked, the data cannot be captured.
- Please do not remove the SD card while accessing to the SD card (Device Access display is displayed in "red" and POWER LED is blinking.). The captured data may be damaged.
- When inserting the large capacity SD card, it may take some time to recognize it.

### How to insert the SD card (SD CARD)

Insert the SD card into the SD CARD slot.

- (1) Open the SD CARD cover.

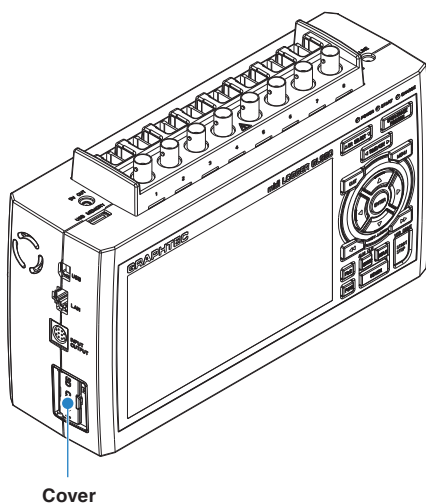

- (2) Insert the SD card until it clicks and is locked.

\* Make sure that the SD card is not locked.

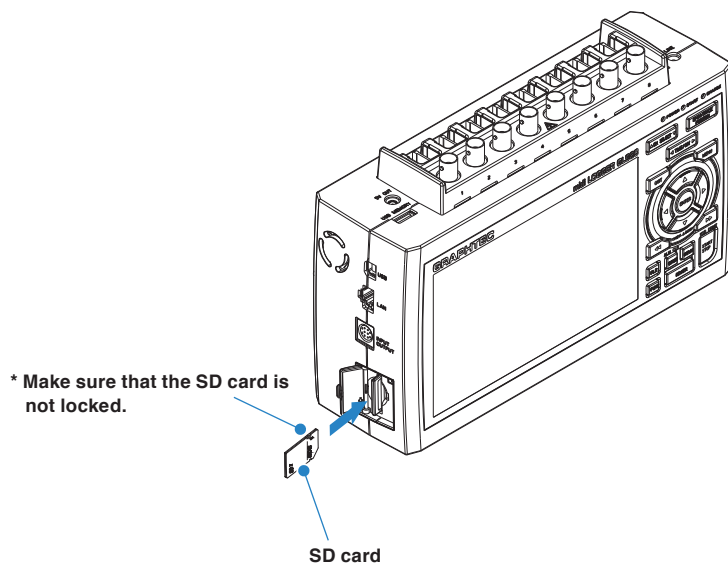

- (3) Close the SD CARD cover.

### How to remove the SD card (SD CARD)

(1) Remove SD card after the device access display (SD card) on the device's screen turns green.



(2) Open the SD CARD cover.

(3) The SD card is unlocked by pushing gently the SD card. Then, remove the SD card.

---

#### **CAUTION**

While accessing the SD card, the device access indicator (SD card) turns red (and the POWER LED blinks).  
Be sure to remove it only when it is green.

---

## 2.10 Installing USB Memory

### ⚠ CAUTION

- When the USB memory is handled, please pay attention to static electricity etc.
- Do not remove the USB memory while it is being accessed (Device access indicator turns red and POWER LED blinks). The captured data may be damaged.
- When using HDD and 4GB or more USB memory, please format with FAT32.

### How to install USB memory

Install the USB memory in the USB memory slot.

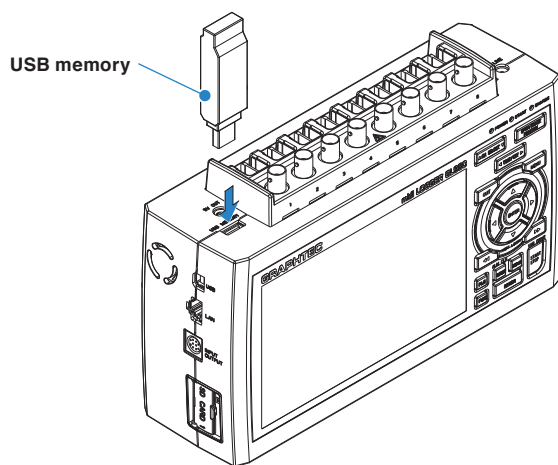

### ⚠ CAUTION

When the USB memory is installed in this device, please pay attention to handle so as not to hit or drop it.

<USB memory specifications>

- Power supply: +5V
- Consumption current: 250 mA or less
- Capacity: No limited (however, up to 4GByte for 1 file)
- \* USB memory with security function such as fingerprint authentication or USB memory without shell (metal part) on the connector part cannot be used.
- \* USB power type HDD cannot be used. Format the HDD to FAT32.

For the latest information and support information, please check the following URL.

<http://www.graphtec.co.jp>

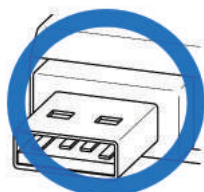

OK

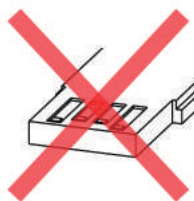

NG

## 2.11 Connecting to a PC

Use the USB or LAN Interface to connect this device to a PC.

### Connection Using a USB Cable

- (1) This device complies with the EMC Directive in the state when the supplied ferrite core is attached to the USB cable.

To connect to the PC with the USB cable, attach the supplied ferrite core to the USB cable as shown in the following figure.

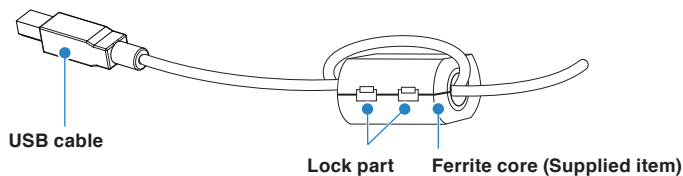

- (2) Connect between this device and PC with the USB cable.

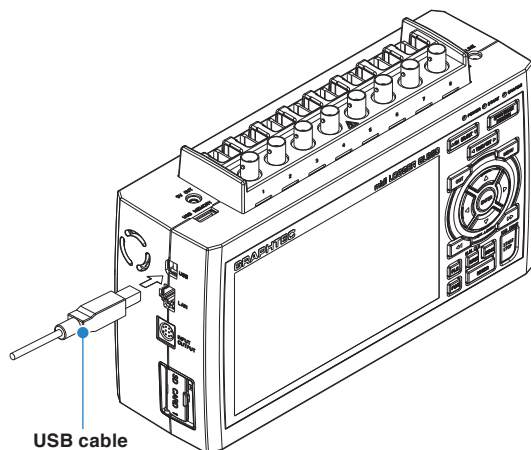

#### **CAUTION**

The USB connector is adjacent to the LAN connector. Make sure the cable is inserted into the correct connector.

#### **CHECKPOINT**

If the USB cable is used, the USB driver must be installed in your PC. Please refer to "USB Driver Installation Manual" in the supplied CD-ROM for the installation procedure.

- Use the cable with A and B connectors to connect this device to a PC.

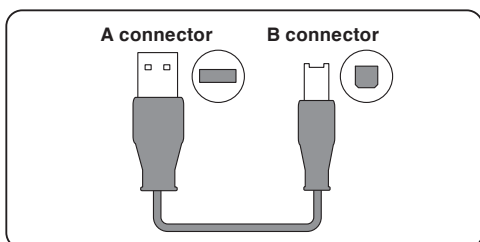

## LAN Connection

(1) This device conforms to the EMC directive when the core is attached to the LAN cable.

When connecting to PC with LAN cable, please attach the supplied core to the LAN cable as shown in the figure below.

Please use the LAN cable of 30 m or less.

Use the LAN Interface to connect this device to a PC.

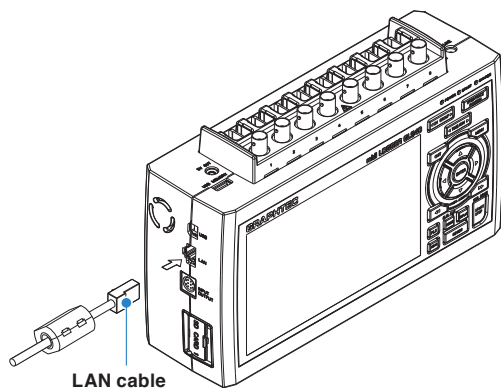

## Cable Types

- Use a crossing cable to connect directly to a PC without using a hub.

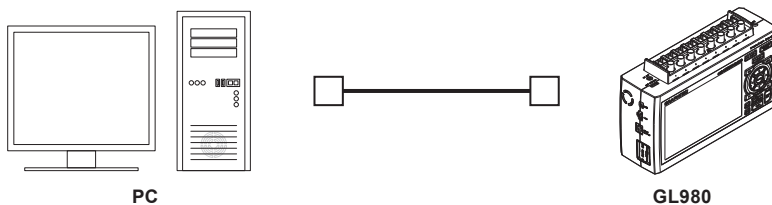

- Use a straight cable when using a hub.

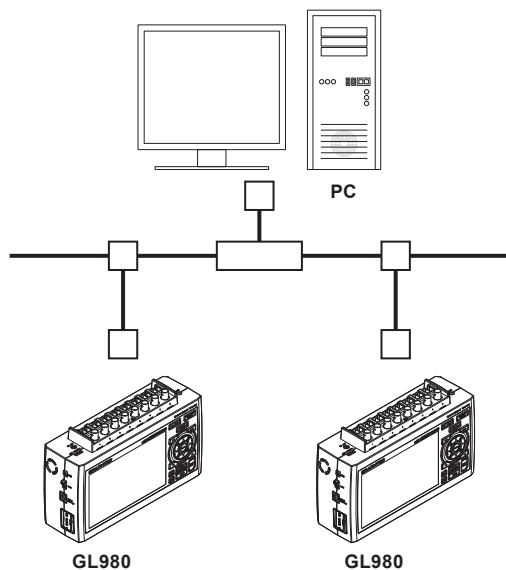

## 2.12 Using the Battery Pack (B-569 : Option)

- The B-569 (optional) is the only battery type that can be used with this device.
- For the driving time with the battery, refer to "4.3 Accessories/Optional Accessories"
- The operating temperature ranges of this device with a battery pack mounted are as follows:
  - Running on battery : 0 to 40°C
  - Battery being charged : 15 to 35°C (at power OFF) / 15 to 25°C (at power ON)

### CHECKPOINT

When the rubber cover is attached, first remove the rubber cover.

### Mounting the Battery Pack

- (1) Remove the locking part of the battery cover and remove the battery cover.

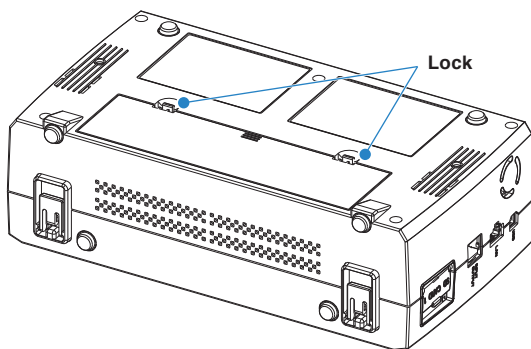

- (2) Mount the battery pack (B-569).

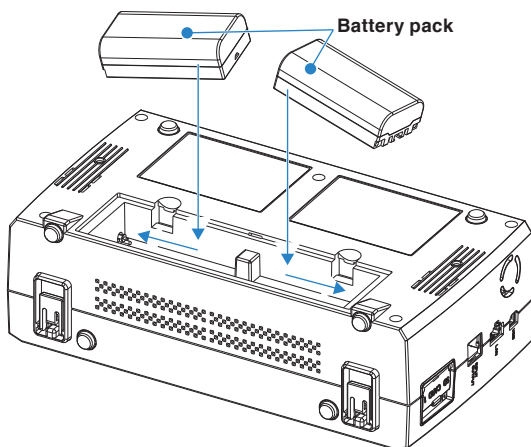

### CAUTION

- Always use two battery packs.
- Do not use a new battery with an old battery at the same time.
- If you are not sure about the amount of charge each battery and then attach full-charged two battery packs.

(3) Attach the battery cover.

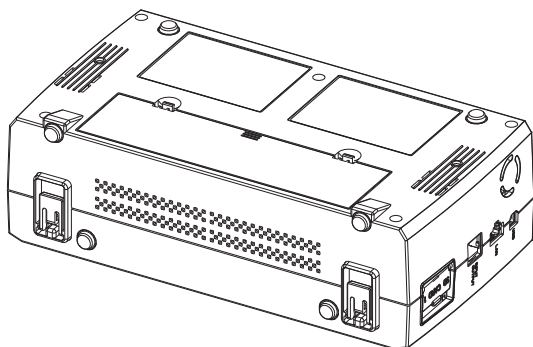

## Charging the Battery

### Expected time required for charging:

- Battery pack x 1: approx. 5 hours
- Battery pack x 2: approx. 10 hours

The battery pack is charged by mounting it in this device, attaching AC adapter to this device.

- (1) Mount the battery pack in this device (Refer to "Mounting the Battery Pack" in the previous page for the mounting procedure.).
- (2) Connect this device to AC power supply. (Refer to "2.4 Connecting the Power Cable and Turning on the Power").
- (3) The CHARGE LED lights.

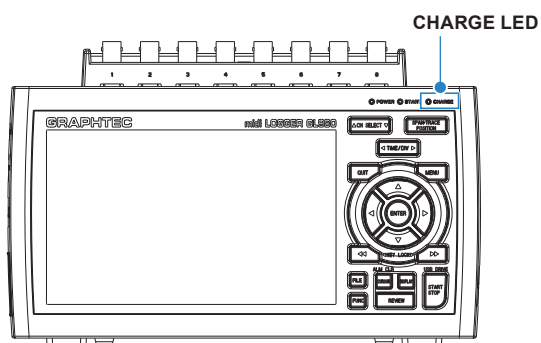

---

## **CHECKPOINT**

- This device is equipped with a temperature monitor function which starts automatic charging as soon as it is cooled down. Therefore, depending on the internal temperature, charging may not be performed immediately.
  - When turning on the power, the temperature that can be charged is about 15 to 25°C. (When turning off the power, it is about 15 to 35°C.)
  - When charging is attempted while the power is ON, charging may not be performed immediately even if the temperature environment conforms to the specification. In such a case, set the Screen Saver settings to ON or perform charging while the power is OFF.
-



---

 **CAUTION**

- During data capture, when the battery power is lower, the capturing stops automatically.
  - When using in conjunction with AC adapter, this device is automatically battery-powered in case of power outage.  
In this case, pay attention to the remaining battery power. If the low-charged battery is inserted, this device may stop abnormally due to power failure or instantaneous interruption.
  - During the power is supplied directly from the DC power without using the AC adapter, when the DC voltage is 16V or less, the battery charge is disabled.
  - When the empty battery is charged in another recorder GL220/820/900, the charging in about 80-90% will stop. Once disconnect and connect the AC adapter, or remove and insert the battery pack.  
The battery pack charging is started in order to charge up to 100%. (It depends on the remaining capacity.)
-

## 2.13 Connecting the Humidity Sensor

Connect the + and - lead wires of the humidity sensor (the B-530: Option) to the desired terminals, and then insert the round connector into the 5V OUT connector on this device.

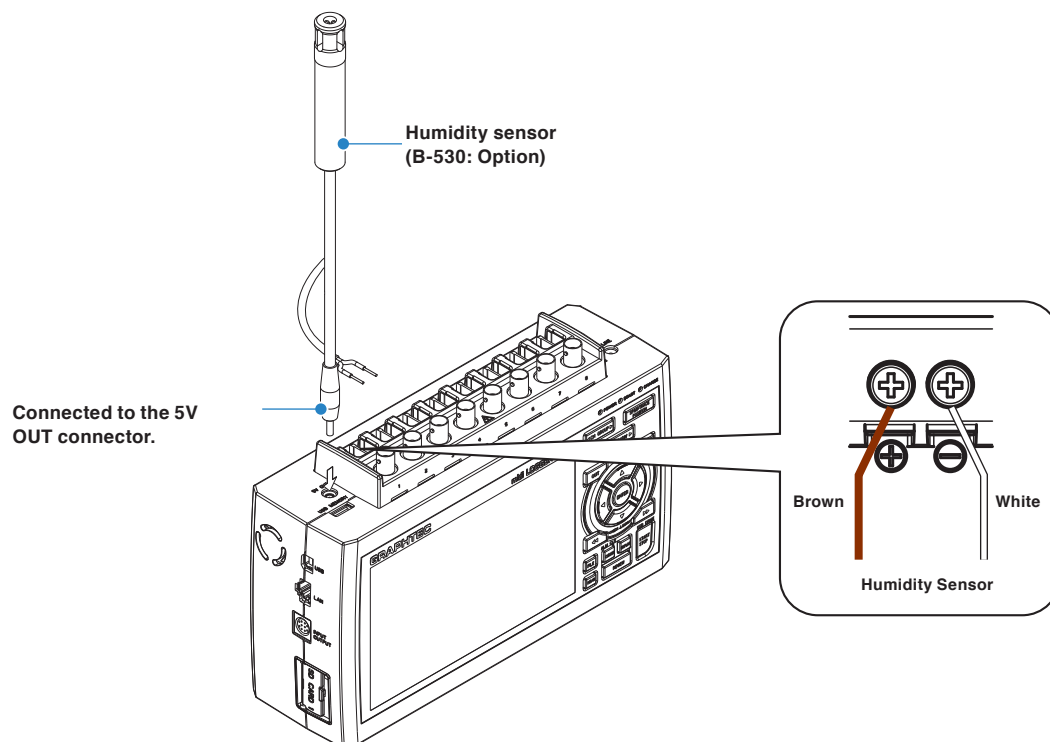

### CAUTION

- Do not use the sensor in a strong electric field environment Measured results may not satisfy to the stated.
- 5V OUT terminal on this device is available for only one humidity sensor.

## 2.14 Precautions to Observe When Performing Measurement

To avoid break-downs or short-circuiting accidents, please make sure to abide by the items written below.

### WARNING

- Do not apply radio-frequency signals with high voltage (50 KHz or above).
- Be sure to use only the AC adapter provided as a standard accessory. The rated power supply range for the adapter is 100 to 240 VAC, and the rated frequency is 50/60 Hz. Do not use any other voltages.
- Do not input the voltage that is exceeding the specification of this device.
  - If a voltage exceeding the specified value is input, the semiconductor relay in the input section will be damaged. Never input a voltage exceeding the specified value even for a moment. It will cause the fire.
  - Have an enough margin from the specification of withstanding voltage when using this device, it have to consider a noise and change of the measurement voltage.
  - Confirm this device is not broken before the input cable is connected to the input terminal.
  - Please take care of the static electricity when the connecting the input cables or the thermocouples.
  - Do not touch the tip of thermocouples with bare hand after the thermocouples are connected to the terminal of this device when the tip of thermocouples is not insulated.  
The static electricity of a human body will cause damage to this device.
  - Do not put the tip of thermocouples to the object which is containing the static electricity when the tip of thermocouples is not insulated. The static electricity of object will cause damage to this device.
  - Do not put the tip of thermocouples to the object which is containing the leaked high voltage of chassis or metal etc. when the tip of thermocouples is not insulated.  
The leaked high voltage of object will cause damage to this device.
  - We recommend that the insulation tape puts on the tip of thermocouples before connecting the thermocouples to the input terminals.  
This will protect this device from the static electricity and the leaked high voltage.
- To prevent electric shock and short circuit accident, do not connect to BNC terminal and screw terminal at the same time.

When using

Please be sure to read the following carefully in order to prevent electric shocks or shorts.

● **Maximum input voltage**

If a voltage exceeding the specified value is input, the parts in the input section will be damaged. Never input a voltage exceeding the specified value even for a moment.

< Between +/- terminals (A) >

- Maximum input voltage : Range of 20mV to 2V :  $\pm 30V$   
Range of 5V to 500V :  $\pm 500V$

<Between input terminal and input terminal (B) >

- Maximum input voltage : 60Vp-p
- Withstand voltage : 1000Vp-p at 1 minute

<Between input terminal and GND (C) >

- Maximum input voltage : 60Vp-p
- Expected transient overvoltage : 1000Vp-p at 1 minute

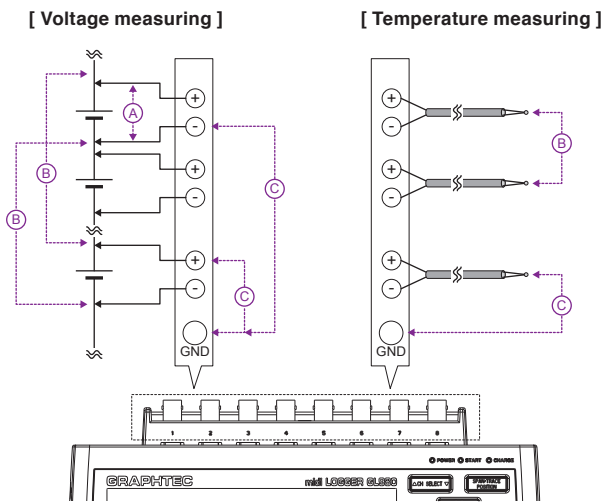

## 2.15 Noise Countermeasures

- **Be sure to connect the chassis GND of the measurement object.**

It may become effective by ensuring that the chassis GND wire of the measurement object is connected to a good ground.

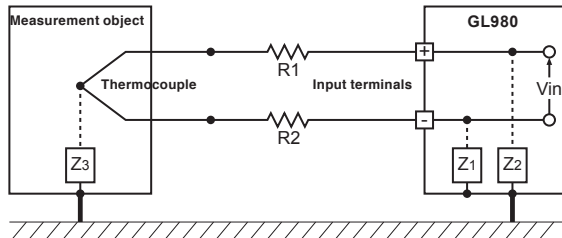

- **Connect the signal chassis GND to the measurement device chassis ground.**

Use a short, thick lead to connect the chassis GND of the measurement object to this device's chassis GND. It will become even more effective if the ground potentials are the same.

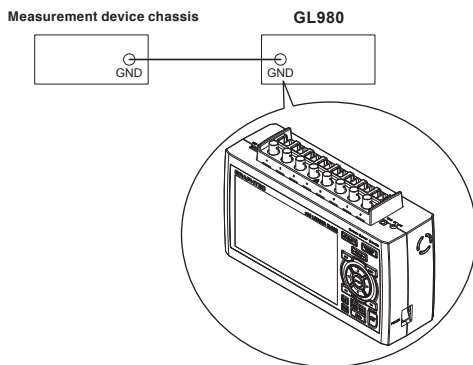

- **Noise countermeasures**

If measured values fluctuate due to extraneous noise, conduct the following countermeasures.

(Results may differ according to noise type.)

Ex 1 : Connect this device's GND to ground.

Ex 2 : Connect this device's GND to measurement object's GND.

Ex 3 : In the AMP settings menu, set filter to any setting other than "OFF".

## 2.16 When Fixing This Device

When fixing this device to prevent the dropout, the two nuts on the back must be used.

\* Recommended tightening torque: 14kgf/cm

When fixing this device, please use it in a vertically placed state.

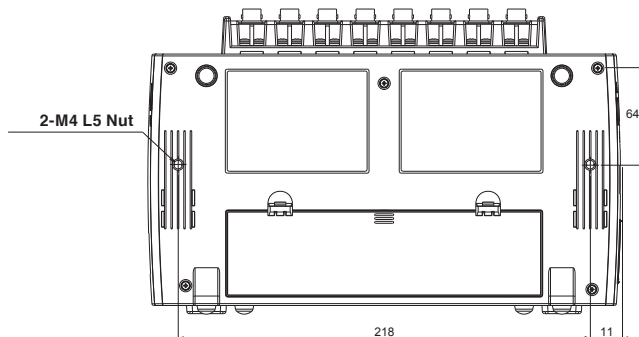

---

**CAUTION**

To prevent possible malfunction, do not block the air vents of this device.

If this device is installed in other than the state described above, the measurement accuracy may not meet the specifications.

---

## 2.17 Setting the Date and Time

If you are using this device for the first time, charge the internal rechargeable battery and then make the date and time settings.

### CAUTION

If this device is not used for a period of approximately six months, the internal rechargeable battery may be discharged and the date and time may revert to the initial settings. If this happens, recharge the battery before using this device.

### How to Recharge the Rechargeable Battery

Using the AC adapter provided, connect this device to a mains power outlet, turn on the power switch, and then leave this device connected for at least 24 hours.

### How to Set the Date and Time

Press the [MENU] key, display the “OTHER” screen, and then set the date and time at the Date/Time Settings sub-menu. For details, refer to “3.4 Setting Menus” - “Date/Time”.







# ***CHAPTER 3 Settings and Measurement***

---

This chapter describes the setting and measurement procedures for this device.

## **PRODUCT SUMMARY**

- 3.1** *Window names and functions*
- 3.2** *Key Operation*
- 3.3** *Description of the display mode*
- 3.4** *Operation Modes*
- 3.5** *Setting Menus*
- 3.6** *WEB Server Function*
- 3.6** *List of Error Codes*

## 3.1 Window names and functions

### Y-T Screen

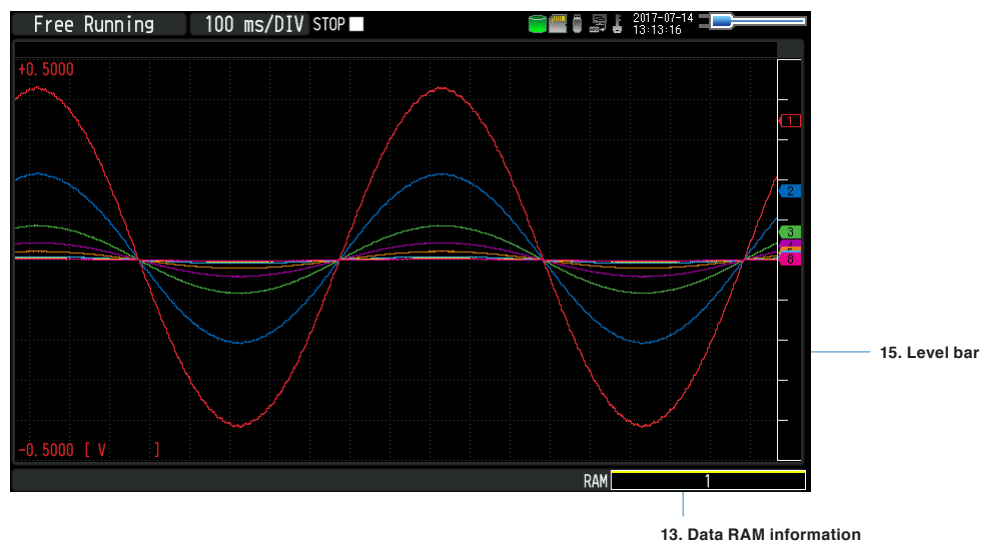
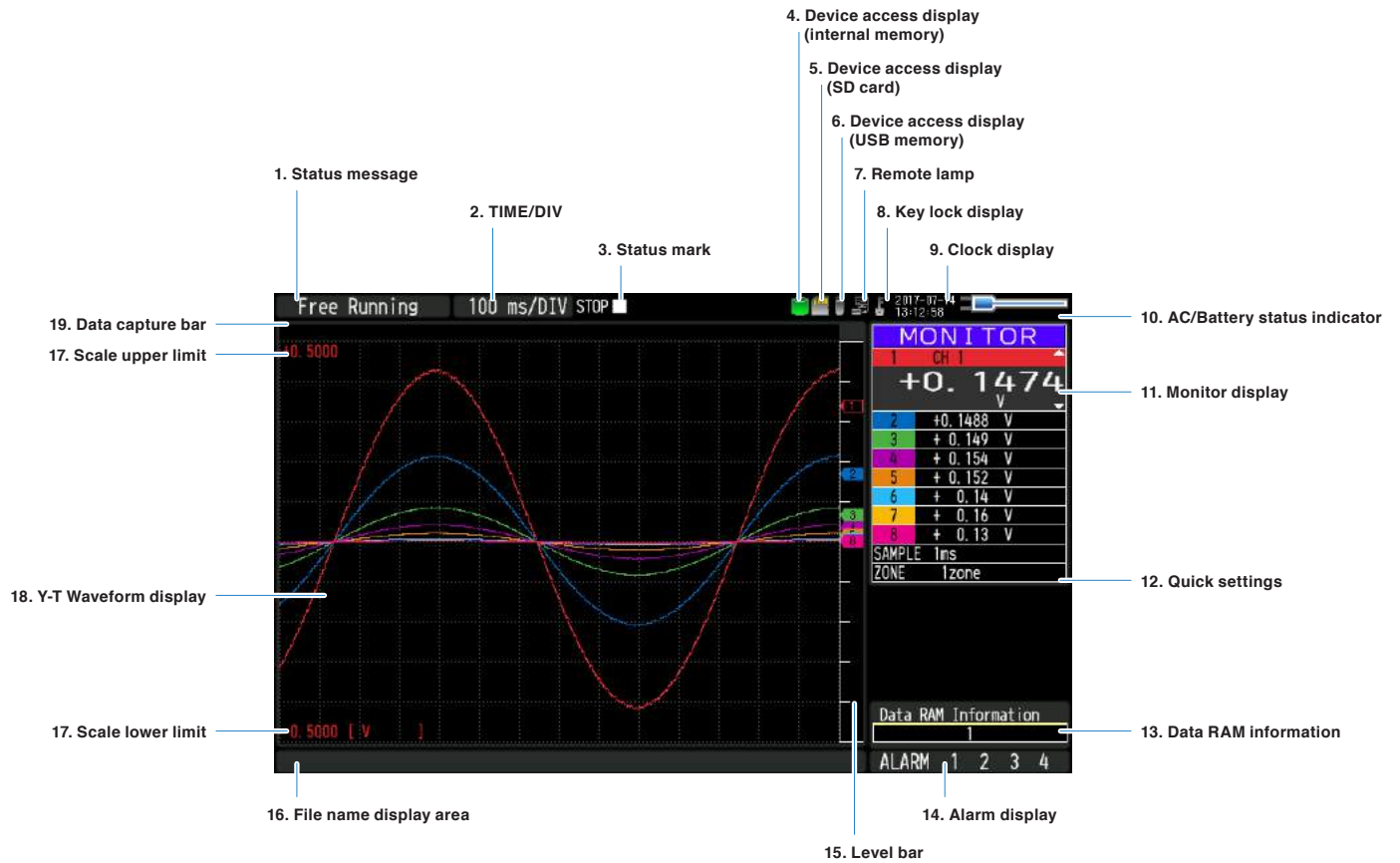

Logging screen

20. Logging display

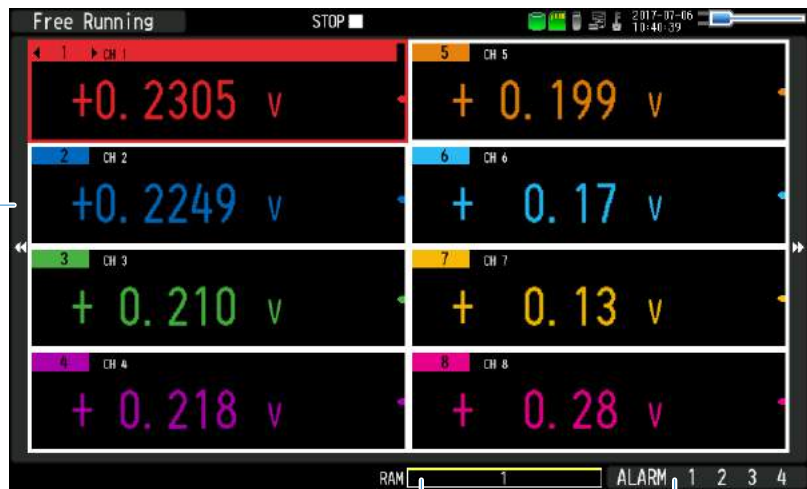

13. Data RAM information

14. Alarm indication

21. Statistical calculation display

The screenshot shows a 'Free Running' statistical calculation display. It features a table with columns for Channel (CH), Value, Max, Min, P-P, and Ave. Below the table, there is a 'RAM' indicator showing '1' and an 'ALARM' indicator with buttons '1', '2', '3', and '4'.

CH	VALUE	Max	Min	P-P	Ave
1 CH 1	-0.1218 v	+0.4356	-0.4175	+0.8530	+0.0083
2 CH 2	+0.0815 v	+0.4380	-0.4181	+0.8560	+0.0087
3 CH 3	+0.102 v	+3.998	-5.067	+9.065	+0.005
4 CH 4	+0.106 v	+4.002	-5.067	+9.069	+0.010
5 CH 5	+0.119 v	+3.997	-5.076	+9.072	+0.001
6 CH 6	+0.10 v	+4.01	-5.09	+9.09	-0.01
7 CH 7	+0.11 v	+4.00	-5.12	+9.12	-0.03
8 CH 8	+0.12 v	+4.20	-5.20	+9.39	+0.04
P1 PULSE 1	0 RPM	1	1	1	1
P2 PULSE 2	0 C	1	1	1	1
P3 PULSE 3	0 C	1	1	1	1
P4 PULSE 4	0 RPM	1	1	1	1

**XY Screen**

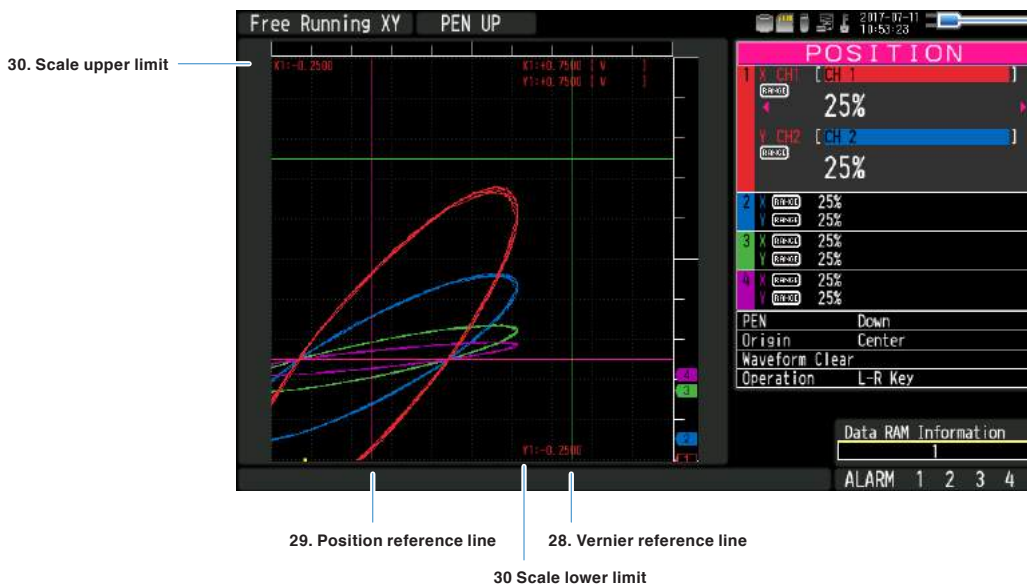
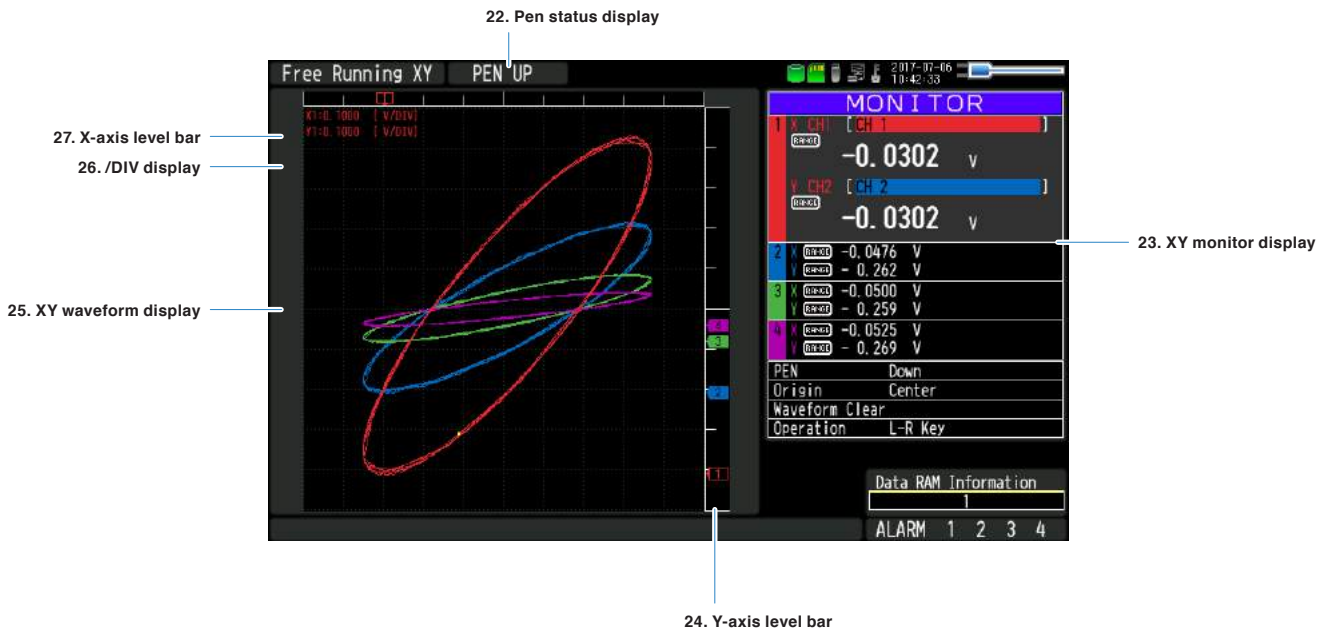

## 1. Status message

Displays the operation status of this device.

<b>Free Running</b>	: Displayed when data is not being captured.
<b>Free Running XY</b>	: Displayed when data is not being captured while XY Screen is used.
<b>Recording pretrigger</b>	: Displayed when the pre-trigger capturing is in progress with the setting to wait for pre-trigger complete.
<b>Armed</b>	: Displayed while waiting for trigger generation after measurement is started.
<b>Rec to Int RAM</b>	: Displayed when data is captured to the internal RAM.
<b>Rec to Int Mem</b> *	: Displayed when data is captured to the internal memory.
<b>Rec to SD card</b> *	: Displayed when data is captured to the SD card.
<b>Rec to USB Mem</b> *	: Displayed when data is captured to the USB memory card.
<b>Recording</b>	: Data capturing operation is performed by our application when connecting to our application, but this status message is displayed when data is not captured to this device.
<b>Finished</b>	: Displayed when this device waits for you to press the [Start/Stop] key to stop it after data capture.
<b>Repeat Waiting</b>	: Displayed when waiting for the elapse of the repeat interval time.
<b>Int RAM Replaying</b>	: Displayed when data in the internal RAM is replayed.
<b>Int Mem Replaying</b> *	: Displayed when data in the internal memory is replayed.
<b>Playing SD card</b> *	: Displayed when data in the SD card is replayed.
<b>USB Mem Replaying</b> *	: Displayed when data in the USB memory is replayed.
<b>Record/Replaying</b> *	: Displayed when data is replayed during capturing.
<b>Auto Save...</b> *	: Displayed when auto save process is in progress.
<b>Backup failed</b>	: Displayed when backup fails (The SD card of the backup destination is removed, etc.).
<b>Demo Wave Mode</b>	: Displayed when demo waveforms instead of measured data are being displayed.
<b>Remote lock off</b>	: Displayed while remote lock is released.

\* For details of data capture such as trigger and repeat etc., refer to “3.4 Setting Menus” - “(3) TRIG settings”.

\* For details of capture settings, refer to “3.4 Setting Menus” - “(2)-2 Captured data file name”.

\* For details of remote lock release function, refer to User’s Manual GL980-2000\_APS.

### CAUTION

Please do not turn off the power when the status message of “Capturing to internal memory” or “Capturing to SD card” is displayed (“\*” status mark).

Please start the operation after making sure that the status mark is switched to "STOP".





## 2. Time/DIV display

With the Y-T Screen, the currently set time scale is displayed.

Time scale means the time per 1 grid on the horizontal axis.

You can adjust the display width of the horizontal axis (T-axis) of the waveform by changing this value.

### 3. Status mark

-  : Appears when neither capture nor replay is in progress.
-  : Displayed when saving the captured data.
-  : Appears when waiting for a trigger during capturing and the stop key after capturing.
-  : Displayed when replaying the captured data.
-  : Displayed when replaying the captured data during data capture (Refer to in “3.2 Key Operation” - “(10) REVIEW”).

---



#### CAUTION

Please do not turn Off the power and do not remove the SD card or USB memory when the status mark indicates other than “STOP”. The data is damaged, and it will not be accessed.

Please start the operation after making sure that the status mark is switched to "STOP".

---

### 4. Device access display (Internal memory)

-  : Internal memory is recognized but not accessed.
-  : Internal memory is being accessed. While the internal memory is being accessed, the POWER LED also flashes.

---



#### CAUTION

Please do not turn Off this device’s power when accessing the internal memory.

The data is damaged, and it will not be accessed.

---

### 5. Device access display (SD card)

-  : SD card is not attached.
-  : SD card is attached but not accessed.
-  : SD card is accessed. Do not remove SD card. The POWER LED also flashes during accessing the SD card.

---

#### CAUTION

Please do not remove the SD card and do not turn Off this device’s power when accessing the SD card.

The data is damaged, and it will not be accessed.

---

## 6. Device access display (USB memory)



: USB memory is not attached.



: USB memory is attached but not accessed.



: USB memory is accessed. Do not remove USB memory. The POWER LED also flashes during accessing the USB memory.

---

### CAUTION

Please do not remove the USB memory and do not turn Off the power when accessing the USB memory. The data is damaged, and it will not be accessed.

---

## 7. Remote lamp



: Indicates local mode. Operations can be conducted on this device.



: Indicates remote mode. With some exceptions, operations must be conducted on a PC.

When you cancel the connection on the application (GL980\_2000-APS), this device automatically returns to local mode. If local mode is not entered, press the [QUIT] key.

## 8. Key lock display



: Not in key lock status. Normal operations are enabled.



: Key lock status. All the keys are locked.







Refer to “(14) To cancel key lock by password” in “3.4 Setting Menus” for details on the key lock.

## 9. Clock display

Displays the current date and time.

For details on date and time settings, refer to “3.4 Setting Menus” - “(6) OTHER settings”.

### 10. AC/battery status indicator

	: Running on AC or DC power supply.
	: Running on the battery. The remaining battery power is 100 to 91%.
	: Running on the battery. The remaining battery power is 90 to 61%.
	: Running on the battery. The remaining battery power is 60 to 31%.
	: Running on the battery. The remaining battery power is 30 to 11%.
	: Running on the battery. The remaining battery power is 10% or below.

#### CAUTION





- Data capture automatically stops when the remaining battery power drops to 10% or below during data capture.  
Auto Save will be performed automatically even if Auto Save is not set while the data is captured to the internal RAM. (Capturing does not stop.)
- The power is automatically turned off when the remaining battery power is 0%.
- Please use the remaining battery display as a guide.  
This indicator does not guarantee the operating time with battery.

### 11. Monitor display of Y-T screen

Displays the input value of each channel and span. Use the [SPAN/TRACE/POSITION] keys to switch the display.

Use the ▲ ▼ keys to select the channel you want to activate (enlarged display).

The waveform of the active channel is displayed at the top.

	: Displays the input value.
	: The span of the active channel can be changed using the ◀▶ keys.
	: The position of the active channel can be changed using the ◀▶ keys.
	: The ON or OFF of the active channel display can be changed using the ◀▶ keys.

For details, refer to “3.2 Key Operation” - “(2) SPAN/TRACE/POSITION”.

As described below, the CH indicating the calculation mark is the channel which calculation between the CHs is enabled (On).

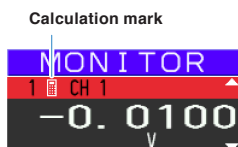

### 12. Quick settings

The settings of the sampling interval and the division of waveform display can be changed. Use the ◀▶ keys to activate the Quick setting and the left/right keys to change values.









\* The "SAMPLE" item cannot be changed during data capture.



### 13. Data RAM information

Displays the status of the internal RAM. The status of the block can be judged by the color of each block. For the number of blocks, set the division number by "memory block division".



-  : Data was not captured. It is an empty block.
-  : Pre-trigger data is captured.
-  : Data is captured.
-  : Data capture is completed but auto save is not performed.
-  : Data capture is completed. Auto save is performed.
-  : Auto save is performed. The auto save progress is indicated by a dark green bar.
-  ← : The yellow line at the top of the block indicates that this device is capturing or the block scheduled to be captured next time.
-  ←

### 14. Alarm display

Displays the alarm output status.

The number with which an alarm has occurred is displayed in red. The channel with the alarm cause has a red input value in the digital display area.

### 15. Level bar

Displays the each channel signal position, trigger position and alarm range.

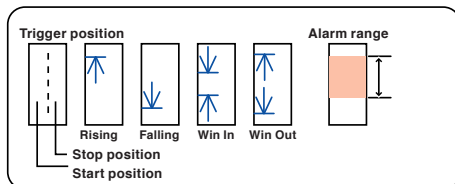

### 16. File name display

(1) During data capture

A capture file name is displayed during capture.

```
<MEM>170711#PREFIX_170711-130955.GBD
```

\* If the ring capturing setting is ON, a file name displayed during capture ends with "\_RINGx" (x represents a number) but the actual file name does not include "\_RINGx".

In the above figure, if the ring capturing is set to ON, the file name during capture will be displayed, for example, as "<SD1>150302\150302-090930\_RING4.GBD" but the actually created file will be "<SD1>150302\150302-090930\_RING4.GBD".

\* For details, refer to "3.4 Setting Menus" - "(2) DATA settings".

(2) During data replay

Information on the time axis of the cursor is displayed during Y-T replay.

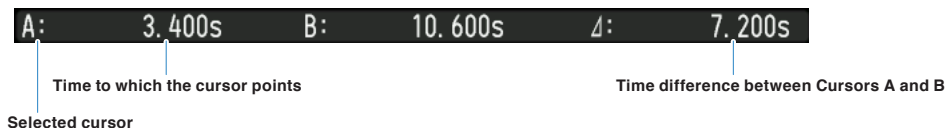

### 17. Scale upper/lower limit

Displays the scale upper/lower limit of the currently active CH.

### 18. Y-T waveform display

Displays the Y-T waveform of the input signal.

(The vertical axis is measured value and the horizontal axis is time.)

### 19. Capture bar

(1) During data capture

Displays the elapsed time and the internal memory and SD card usage status.

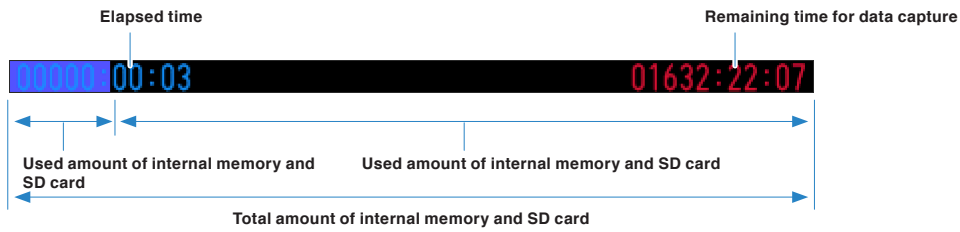

For example, when you are using a 4GB SD card and using about 100MB before capturing, the total capacity of the SD card is 4 GB, the usage of the SD card is about 100MB, and the remaining capacity of the SD card is about 3.9GB. When the captured time elapses, the usage of the SD card increases and the remaining capacity of the SD card decreases.

The remaining capturable time shows the time that can be captured with the remaining capacity of the SD card.

However, when the relay capturing function is set to Off, even when the remaining capacity of the SD card exceeds 4GB, it indicates the remaining time that can be captured to 1 file 4 GB.

\* Remaining time more than 99999 hours is displayed as "++++:++:++".

(2) During data replay

Displays the display position, cursor position, and trigger position graphically.

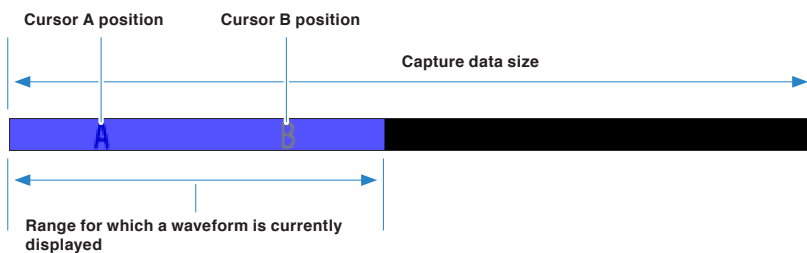

## 20. Logging display

Displays the digital value of the input signal in large character.

The display can be divided in 2, 4 or 8 displays. You can select the analog CH, logic, pulse CH to be displayed.



2-divided

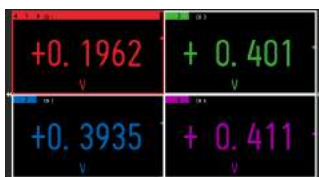

4-divided



8-divided

## 21. Real time statistical calculations display

Displays the real time statistical calculation result (4-calculation simultaneous display).

CH	VALUE	Max	Min	P-P	Ave
1	CH 1 — 0.3 V	+ 0.7	— 0.6	+ 1.3	+ 0.1
2	CH 2 — 0.3 V	+ 0.8	— 0.5	+ 1.3	+ 0.1
3	CH 3 — 0.3 V	+ 0.6	— 0.7	+ 1.3	— 0.1
4	CH 4 — 0.3 V	+ 0.7	— 0.6	+ 1.3	+ 0.0
5	CH 5 — 0.4 V	+ 0.7	— 0.6	+ 1.3	+ 0.0
6	CH 6 — 0.5 V	+ 0.5	— 0.8	+ 1.3	— 0.2
7	CH 7 — 0.3 V	+ 0.6	— 0.7	+ 1.3	+ 0.0
8	CH 8 — 0.3 V	+ 0.7	— 0.9	+ 1.5	— 0.1

Real time value

Maximum value

Minimum value

P-P value

Average value

## 22. Pen status display

Displays the UP/DOWN status of the pen in the XY screen.

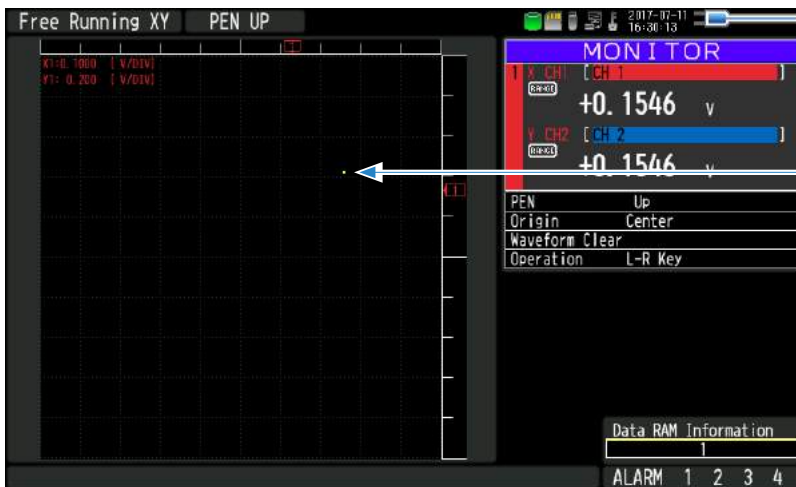

The current pen position is drawn with a yellow dot.

When pen is UP status

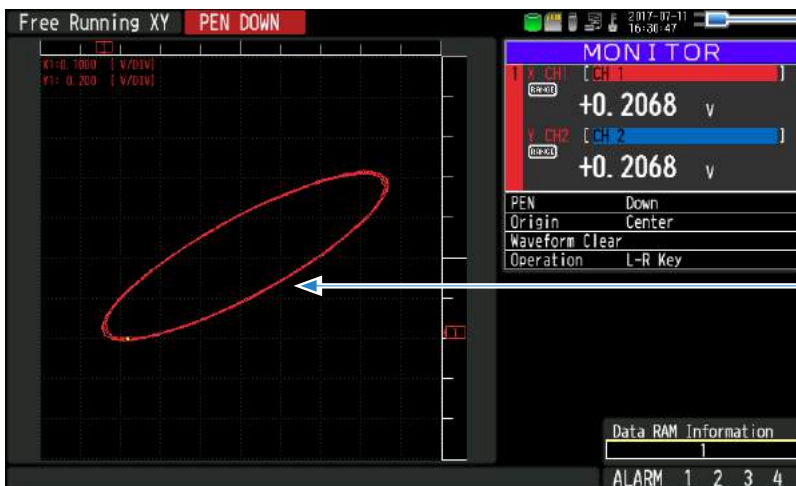

The trajectory of the pen is drawn with color used with XY-CH.

When pen is DOWN status

When the capture is started, the pen becomes automatically the pen DOWN status.

### 23. XY screen monitor display

Displays the input value of CH set to XY-axis, /DIV display, Position, Vernier. To switch the display, use the "SPAN/TRACE/POSITION" key.

L-R key mode:

You can select the XY-CH and the axis to be activated (enlarged display) with the ▲ ▼ keys or CH SELECT key. In addition, the waveform display of active XY-CH, is displayed at the top.

You can change the settings of the selected axis of the selected active XY-CH with the ◀ ▶ keys.

Cross key mode:

You can select XY-CH to be active (enlarged display) with the CH SELECT key. In addition, for active XY-CH, the waveform is displayed at the top.

For the selected active XY-CH, you can change the settings of the X-axis with the ◀ ▶ keys, and the Y-axis with the ▲ ▼ keys.

- MONITOR : Displays the input value.
- RANGE/SPAN : Changes the Range/Span of active XY-CH using the keys.
- POSITION : Changes the Position of active XY-CH using the keys.
- VERNIER : Changes the Vernier of active XY-CH using the keys.

#### CAUTION

- The settings of Range/Span, Position and Vernier belong to each analog CH.
- When the same analog CH is assigned to another XY-CH, changing the setting of one XY-CH changes all the XY-CH settings at the same time.

For details, refer to “3.2 Key Operation” - “(2) SPAN/TRACE/POSITION” and “3.3 Operation Modes” - “(3) XY waveform display” - “XY monitor display”.

In XY-CH display, the contents of the X-axis (horizontal axis) are displayed on the upper row and the contents of the Y-axis (vertical axis) are displayed on the lower row.

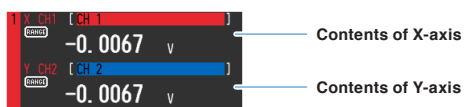

### **24. Y-axis level bar**

Displays the signal position of CH set on the Y-axis.

In the Y-axis level bar, the trigger range and the alarm range are not displayed.

### **25. XY waveform display**

Displays XY waveform graph.

You can set any analog CH to X-axis (horizontal axis) and Y-axis (vertical axis) respectively.

### **26. /DIV display**

Displays the measurement amount (unit) for one grid of XY waveform graph.

### **27. X-axis level bar**

Displays the signal position of CH set on the X-axis.

In the X-axis level bar, the trigger range and alarm range are not displayed.

### **28. Vernier reference line**

Displays the Vernier reference line when the POSITION setting and the Vernier setting are displayed in the XY monitor display or when "Origin" is selected by the Quick setting (It is a green straight line).

When the Vernier is set to 100%, Vernier reference line is displayed at the position of 5DIV.

When the Vernier setting is changed, Vernier reference line moves according to the percent (%) of Vernier.

For example, When the Vernier is set to 80%, the Vernier reference line moves to the position of 4DIV.

For details of Vernier function, refer to "3.3 Operation Modes" - "(3) XY waveform display" - "Vernier".

### **29. XY position reference line**

Displays when the Position setting and the Vernier setting are displayed in the XY monitor display or when "Origin" is selected by the Quick setting (It is a pink straight line).

In the Range mode, the reference value is 0V (0Vrms).

In the Span mode, the reference value is the center position of the span.

The XY position reference line indicates the display position of the reference value.

For the XY position, the reference position can be set to the left (lower) of the XY graph as 0% and the right (upper) as 100%. (Please be careful because it is different from the position setting of the Y-T graph.)

For details of the XY position function, refer to "3.3 Operation Modes" - "(3) XY waveform display" - "XY position".

### **30. XY upper/lower scale**

Displays the XY upper/lower scale when the Position setting and the Vernier setting are displayed in the XY monitor display.

The measured values of the left and right edges (X-axis) and the upper and lower edges (Y-axis) of the XY graph are displayed.



## 3.2 Key Operation

This section describes key operation.

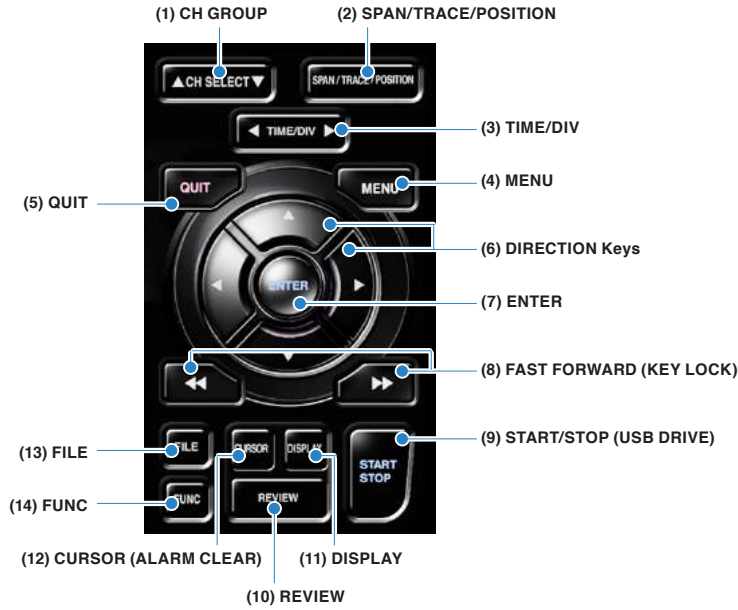

### (1) CH GROUP

Moves CH and item in monitor display.

Use ▲ ▼ keys of CH SELECT to move the logging screen and real time statistics calculation screen up and down.



Y-T waveform screen

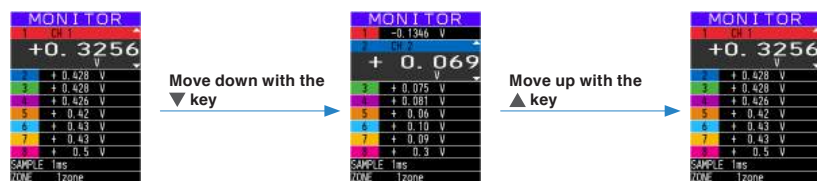

XY waveform screen



**(2) SPAN/TRACE/POSITION**



Switches the information in the monitor display.  
 This is used to change the settings related to waveform display during Free Running (when stopped), data capture and data replay.  
 Pressing this key will switch displays as shown below.

Y-T screen

MONITOR	SPAN	POSITION	TRACE
Displays digital values (default status)	Allows changing of the span value	Allows changing of the position	Allows turning ON/OFF of the waveform display * Data is captured even if OFF is set.

Use CH SELECT key or ▲ ▼ keys to move the CH.

Change the contents of the selected CH with ◀ ▶ keys.

- \* When ALL is set, setting values for CH1 is reflected on other channels. When CH1 is OFF, ALL setting is disabled.
- \* When Logic CH is selected, use ◀ ◀ ▶ ▶ keys to select individual CH of Logic.



XY screen

MONITOR	RANGE/SPAN	POSITION	VERNIER
Displays the digital value. (Default status)	Allows changing of the range/span value (waveform amplitude).	Allows changing of the position (center position of waveform).	Allows changing of the vernier (fine adjustment of waveform amplitude).

- L-R key mode  
 Use CH SELECT key or ▲ ▼ keys to move XY-CH and axis.  
 Use ◀ ▶ keys to change the contents of selected XY-CH and axis.
- Cross key mode  
 Use CH SELECT key to move XY-CH.  
 Use the ◀ ▶ keys to change the contents of the X-axis, and use ▲ ▼ keys to change the contents of the Y-axis.  
 (In the Quick setting area, use ◀ ▶ keys to change the contents.)

### (3) TIME/DIV



Press the [TIME/DIV] key to change the time axis display width.

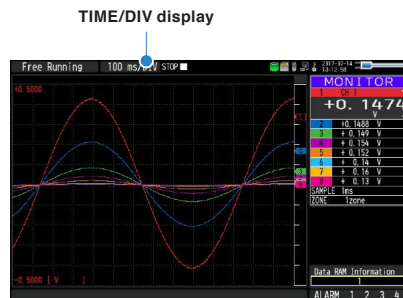

### (4) MENU



Open the settings window to capture data. For details on settings, refer to “3.4 Setting Menus”.



\* For the “Remote lock release function” to temporarily release the control from PC software, refer to APS (GL-Connection)-UM-109-02.

### (5) QUIT (LOCAL)



This key is primarily used for the following operations.

- To cancel a setting during menu configuration.
- To return to the MONITOR screen when the SPAN/TRACE/POSITION screen is displayed.
- To cancel remote status (in which keys are disabled) through interface control.
- To close the menu screen.
- To quit data replay.
- To stop drawing the XY replay waveform.
- To clear the Real time statistical calculation. (only during free running)

**(6) Direction Keys**



This key is primarily used for the following operations.

- To move a menu or setting item during menu configuration.
- To move the cursor during replay.
- To move the active channel in the “Monito display” and “Logging screen” (▲ ▼ keys).
- To change the setting of SPAN/TRACE/POSITION (◀▶ keys).
- To change the Quick setting (◀▶ keys).
- To change the channel to be displayed “Logging screen” (◀▶ keys).

**(7) ENTER**



This key is primarily used for the following operations.

- To finalize setting items during menu configuration or open submenus.

**(8) FAST FORWARD key (KEY LOCK)**



This key is primarily used for the following operations.

- To move the cursor at high speed during replay.
- To change the display order of the files in the file selection tool.
- To set key lock (Hold down the left/right FAST FORWARD key for at least two seconds. Press again to unlock)

A password for canceling the key lock can be specified.

For details, refer to “3.4 Setting Menus” - “(14) To cancel key lock by password”.

- To change the display mode in the “Logging display” and “Real time statistical calculation display”.

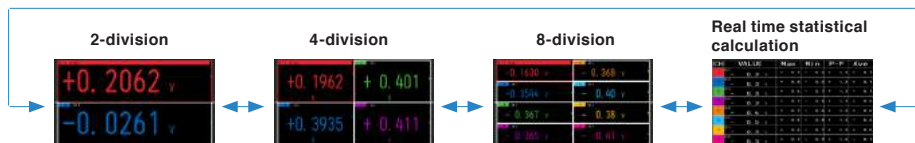

- Select individual logic CH with Logic CH in Y-T monitor screen.



**(9) START/STOP (USB Drive Mode)**

This key performs the following two operations:

<Starts/stops capture>

- During Free Running, starts capture.
- During capture, stops capture.

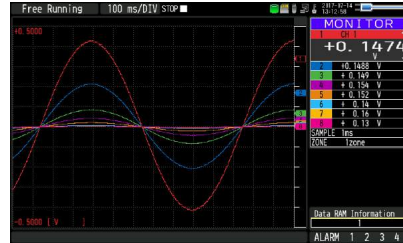
**USB Drive Mode**

In the “USB Drive Mode”, you can check the internal memory and SD card as an external storage device on the PC.

They are recognized as two external storage media.

You can easily transfer and delete files because two external storage media are recognized as a removable disk.

1. Using a USB cable, connect to the PC.
2. While pressing the [START/STOP] key, turn on the power.
3. The external storage media is recognized by the PC and data exchange becomes possible.

\* In USB Drive Mode, the display on this device becomes as follows:

**CAUTION**

- To exit USB Drive Mode, turn off and on the power again.
- In USB Drive Mode, no operation including data capture and data replay is available.
- USB memory does not conform to USB Drive Mode.

\* For the “Remote lock release function” to temporarily release the control from PC software, refer to APS (GL-Connection)-UM-109-02.

**(10) REVIEW**



This key is used to replay captured data.

- During Free Running, captured data is replayed.  
Display the "Data Replay Source" screen, and then set the internal RAM data or file you want to replay.

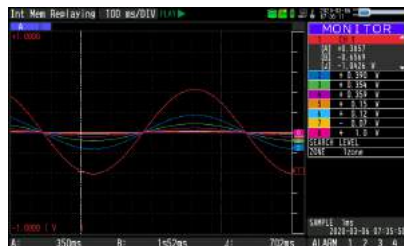

- While capturing data, currently captured data is replayed.

<Replay display>

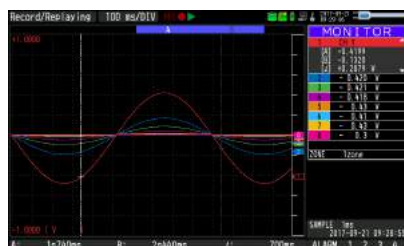

To exit the replay display, press the [QUIT] key.

**CAUTION**

For CSV-formatted data, only the data captured by this device can be replayed.

Also, when the data captured in CSV format is replayed, the unit of the temperature data is displayed in “deg C” rather than “°C”.

## 11) DISPLAY



This key is used to switch the screen mode.

When running Free Running (when the capturing is stopped), data capturing, and data replaying during the capture, the screen mode can be switched.

Pressing this key switches the screen display as follows:

<When Free Running and data capturing>

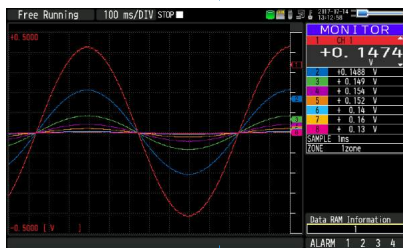

<Waveform + Monitor display>

Displays the Y-T waveform and the Monitor display. The settings can be changed using the [SPAN/TRACE/POSITION] key.

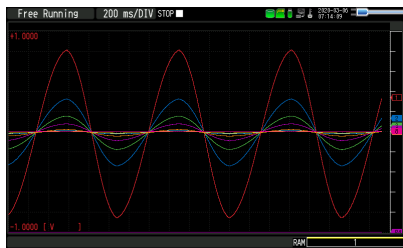

<All waveform screen>

Displays only the waveform in full screen mode.



<Logging display + Real time statistical calculation screen>

Displays digital values and two calculation results in large letters.

Use the ◀◀▶▶ FAST FORWARD keys to change the display mode. The calculation results are displayed only when switched to "Real time statistical calculation screen".

Refer to "3.2 Key Operation" - "(8) FAST FORWARD key (KEY LOCK)" for details on "Real time statistical calculation screen".

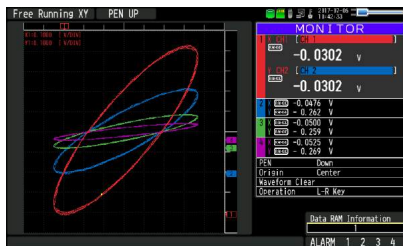

<XY screen>

Displays XY waveform and XY monitor display.

In addition, You can change the settings" using SPAN/TRACE/POSITION" key.



**(12) CURSOR (ALARM CLEAR)**



- This key is used to switch between cursors A and B during replay. Pressing this key switches between cursor A and B. For details on cursor operation, refer to “3.4 Setting Menus” - “(10) Data replay menu”.

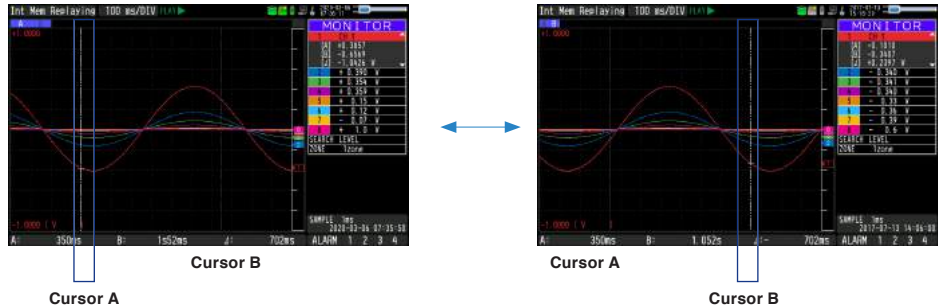

- When the alarm setting is “Hold generated Alarm”, the maintained alarm is cleared.



**(13) FILE**



- This key is used to perform the file-related operations.
- Performs the operations (copy and delete, etc.) for the internal memory, SD card and USB memory.
  - Performs the screen copy
  - Saves all data or data between cursor A and cursor B during replay (can be set during replay only)
  - Saves the data in the internal RAM to a file.
  - Saves or reads the currently set conditions. (can be set during Free Running only).
  - Replaces the SD card or USB memory during data capture (Settable when backing up.).
- For details on file operation, refer to “3.4 Setting Menus” - “(7) FILE menu”.



**(14) FUNC**



Performs the function operation.

You can execute the shortcut with this key by selecting the function to be frequently used in advance. In addition, it is possible to select whenever you want.

For details of function operation, refer to "3.5 Setting Menus" - "(6) OTHER settings" - "FUNC key settings".

Shortcut execution mode: The set operation is executed immediately (shortcut execution).

Selection execution mode: Select the operation you want to execute and then execute it.

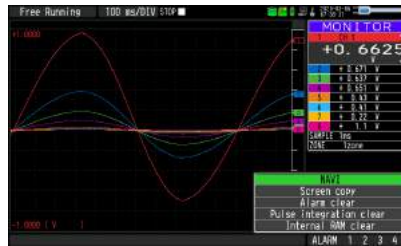

Using the ▲ ▼ keys, select the execution content that you can select and then press the ENTER key to execute it.

### (15) Key lock release with password

A password can be set to device to cancel the key lock.

(No password is set at factory default.)

<Operation flow>

1. Set the password.

Press the ◀, ▶, and ENTER keys at the same time to display the password setting screen shown below.  
Specify a 4 digit password.



Use the ◀, ▶, ▲, ▼ keys to select numbers. Press the [ENTER] key to confirm the password.

Specifying 0000 will disable password operation.

In case you forgot your password, please contact us to acquire the master password.

2. Set the password.

Hold down the ◀◀ and ▶▶ keys together for at least two seconds.

3. Cancel the key lock.

Hold down the ◀◀ and ▶▶ keys together again for at least two seconds.

The password setting screen shown below will be displayed. Set a password.



Entering an incorrect password will not cancel key lock.

Key lock state will be retained when power is turned off.

## 3.3 Description of the display mode

### (1) Y-T waveform display

The Y-T waveform is a graph in which the vertical axis is measured value (Y) and the horizontal axis is time (T).

The horizontal axis (T) can be adjusted by Time/DIV setting. Adjust the display width of the horizontal axis (T) or of the waveform by changing this value.

With the vertical axis (Y), the display position and display width can be adjusted by range setting, span setting (position setting) and zone setting.

The graph waveform can be turned On/Off by trace setting. Even when trace (display) is off, the data is saved in the internal RAM, internal memory, SD card, USB memory.

#### Display format

The Y-T waveform display screen has two display formats.

##### ●Waveform + Monitor screen

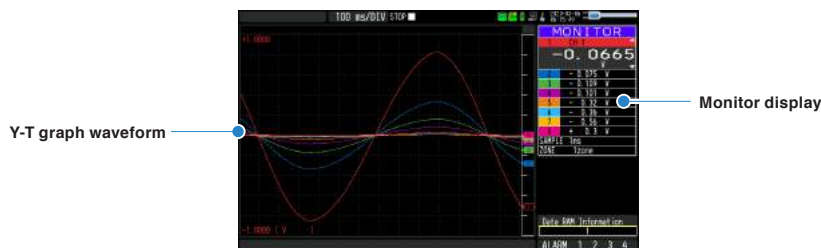

Using Y-T graph waveform on the left side and digital value on the right side, currently measured values can be monitored.

##### ●Full waveform screen

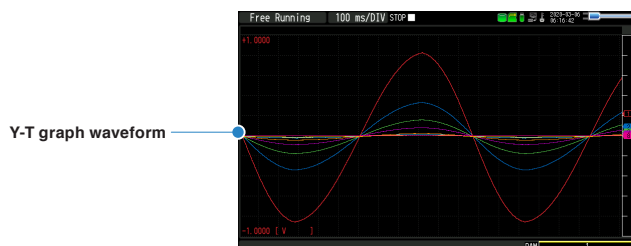

With this display format, you can display the time axis of Y-T graph waveform widely by hiding the monitor display.

## Zone division

Zone division is a function to divide the Y-axis of the Y-T graph into multiple zones and display them so that the graphs do not overlap.

You can select from 1-zone (no zone division), 2-zone division, 4-zone division or 8-zone division.

Analog CH and pulse CH can be freely allocated to each zone.

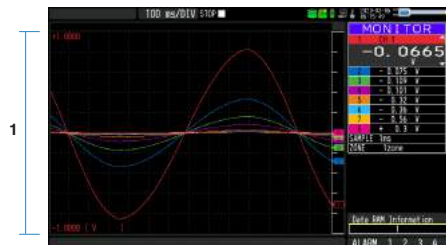

1-zone (no zone division)

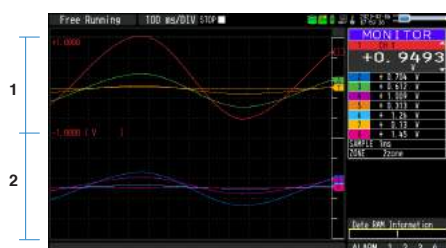

2-zone division

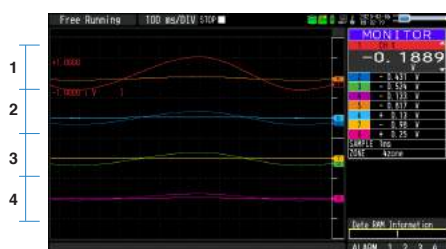

4-zone division



8-zone division

For Logic CH, 10 zones are provided in advance, so you can select the zone to display the Logic CH waveform from them.



10-zone division



### Active CH (priority display CH)

Active CH is a CH that displays in priority to other CHs.

The CH selected in the monitor display is active CH.

The active CH is displayed above the display of the other CH, making it easy to see.



CH1 is active CH.  
Since the waveform of CH 2 is hidden under the waveform of CH1, it cannot be visually recognized.



CH2 is active CH.  
The waveform of CH2 is displayed on the top, so you can visually recognize it.

### Time/DIV

Time/DIV is a function that you can enlarge or shrink the horizontal axis (T) of the Y-T graph waveform to be displayed.

You can set the time with one grid of graph.

The shorter the set time, the larger the horizontal axis (T).

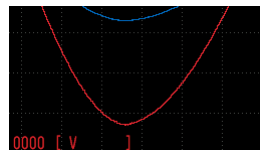
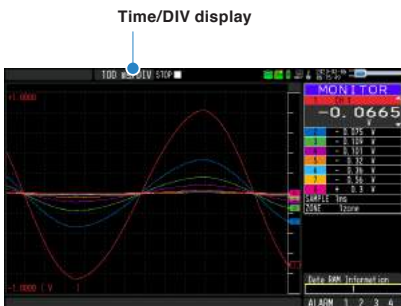

Set time with one grid of graph.

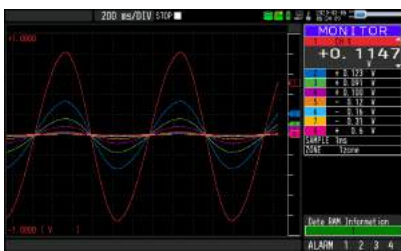

200ms/DIV

Enlarge

Shrink



100ms/DIV

Use DISP menu and TIME/DIV key to set Time/DIV.



## Span

Span is a function to set measurement value of the upper and lower edges in the zone.

By the span setting, you can enlarge or shrink the vertical axis (Y) of the Y-T graph waveform to be displayed.

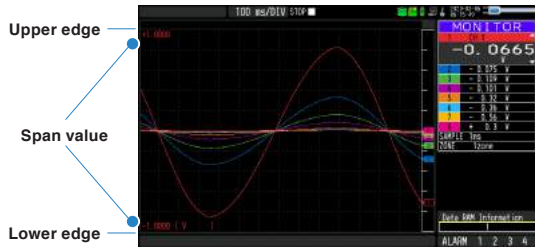

The span value is displayed as the scale display of the CH set to the active CH.

The span value can be changed in the AMP menu. In addition, you can perform simple setting from the monitor display.



In the Span setting, use the ◀▶ keys to change the amplitude of the span. The smaller the amplitude value, the wider the graph waveform is displayed.

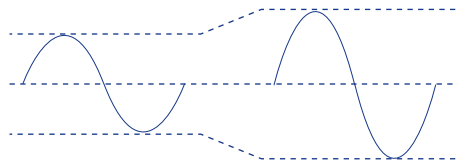

In Position setting, use the ◀▶ keys to move the span parallel.

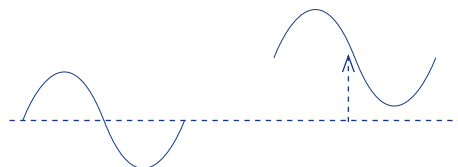

## Monitor display

The monitor display is displayed on the right side in the "Waveform + Monitor screen".



The monitor display has the following functions.

- Displays the measured value with a digital value.
- Displays CH where the alarm occurred.
- Sets active CH.
- Performs simple setting of SPAN, POSITION and TRACE.
- Operates Quick setting.

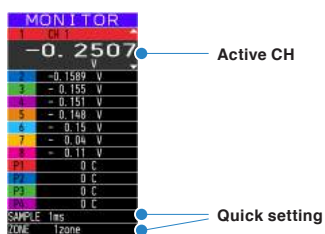

### CAUTION

The CH which the input is set to Off is not displayed.



## Digital display of measured value

<Analog CH/Pulse CH>

During Free running/capturing

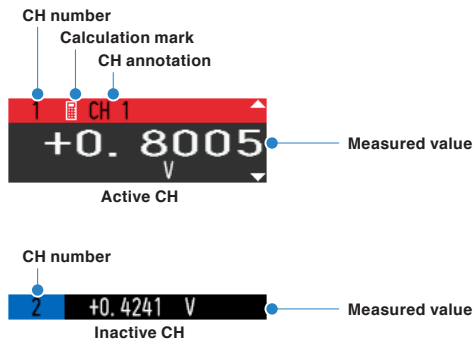

CH number : Measured CH number.

Calculation mark : Displayed when calculation between channels is set.

CH annotation : An annotation set to CH is displayed. When the number of annotation characters is larger than the display area, all the character strings are displayed by scrolling to the left.

Measured value : The currently measured value (instantaneous value) is displayed.

When an alarm occurs, the measured value is highlighted in red



During replaying

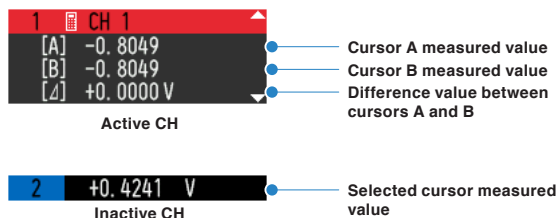

Cursor A measured value : The measured value of the data pointed by cursor A is displayed.

Cursor B measured Value : The measured value of the data pointed by cursor B is displayed.

Difference value between cursors A and B : The difference of measured values between cursor A and B is displayed. When cursor A is selected, value from B value to A is displayed, and when cursor B is selected, value from A value to B value is displayed.

Selected cursor measured value : The measured value of the data pointed to by the currently selected cursor is displayed.

<Logic CH>

- During Free running/capturing

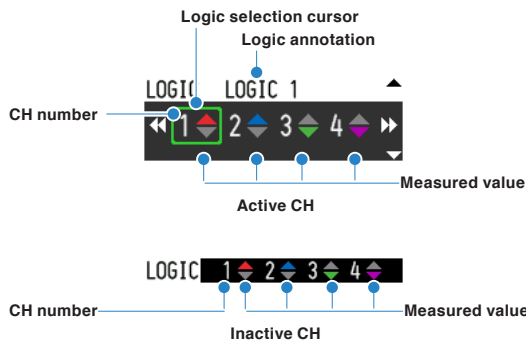

CH number : Logic CH number

Logic annotation : Annotation of the logic CH selected by the logic selection cursor is displayed.

Logic selection cursor: Select individual logic CH. Use ◀◀ and ▶▶ keys to move on the logic CH.

Measured value : The measured value of the logic CH is displayed.



: High level



: Low level

- During replaying

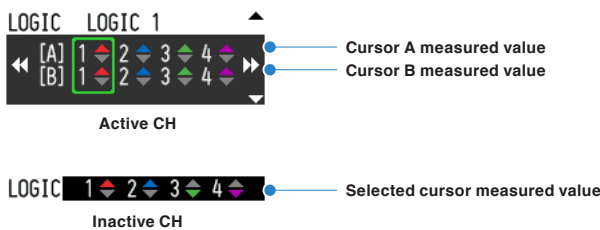

Cursor A measured value : The measured value of the data pointed by cursor A is displayed.

Cursor B measured Value : The measured value of the data pointed by cursor B is displayed.

Selected cursor measured value : The measured value of the data pointed to by the currently selected cursor is displayed.

## Set active CH

You can switch the active CH by operating the CH SELECT key or the ▲ ▼ keys.

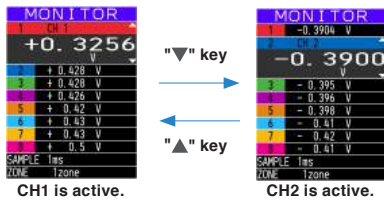

## Simple setting of SPAN /POSITION/TRACE

You can perform each setting by pressing the "SPAN/TRACE/POSITION" key.

XY screen



Use CH SELECT key or the ▲ ▼ keys to move on the CH.

Change the contents of the CH selected with the ◀▶ key.

\* When ALL is set, setting values for CH1 is reflected on other channels.  
When CH1 is OFF, ALL cannot be set.

\* When Logic CH is selected in "MONITOR" or "TRACE", use ◀◀ and ▶▶ keys to select individual CH of logic.



### Quick setting

Quick setting is a function that you can perform the settings in the monitor display without opening the setting menu.

- Sampling interval (SAMPLE)



You can change the sampling interval setting.

Use the ◀▶ keys to change it. However, you can only change it only while Free running is executed. You cannot change it during capturing. The sampling interval is not displayed during replaying.

When changing the sampling interval, the Time/DIV value may be changed depending on the limitation.

- Zone division (ZONE)

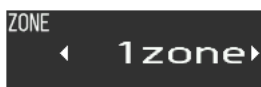

The number of zone divisions can be changed.

Use the ◀▶ keys to change it. When changing the number of zone divisions, the setting of CH allocated to the zone is initialized.

You can change the number of zone divisions at any time.

- Search (SEARCH)



Performs waveform search according to the level search conditions set in the Data Replay menu during replaying.

Use ◀ key to search to the past direction and use the ▶ key to search to the future direction.

Before using this function, set the search level from the Data Replay menu.

## (2) Logging display/real time statistical calculation display

The logging display is a function to digitally display the currently measured value with large letters on the display screen.

Visibility is improved by displaying it on the screen with large letters.

Real time statistical calculation display is a function to calculate and display maximum value, minimum value, P-P value, and average value. Use DISP menu, FUNC key function and QUIT key to clear the statistical calculation during Free running.

Also, the statistical calculation is cleared when the capturing is started.

To switch between display modes, press the ◀◀ and ▶▶ keys.

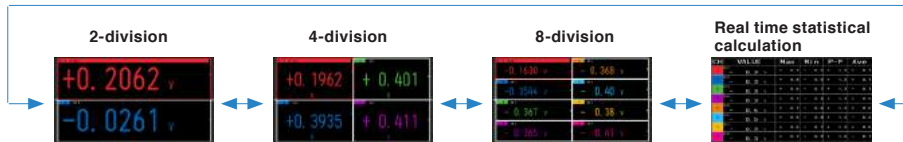

Other than the real time statistical calculation display, the following key operations are possible. Use CH SELECT key or the ▲ ▼ " keys to move on the selected section.

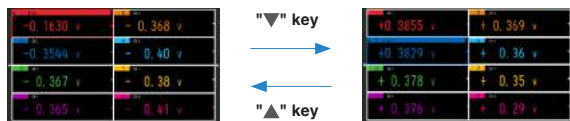

Use the ◀▶ keys to change the CH displayed on the selected section.

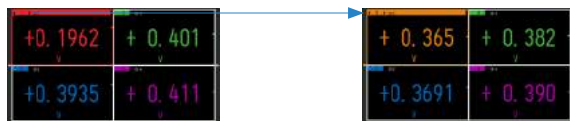

### Logging display

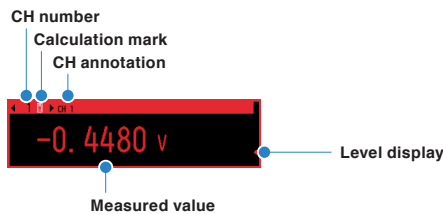

- CH number : Measured CH number.
- Calculation mark : Displayed when calculation between channels is set.
- CH annotation : Annotation set to CH is displayed.
- Measured value : Currently measured value is displayed.
- Level indication : Level position of measured value is displayed with pointer.

### Real time statistical calculation display

CH	VALUE	Max	Min	P-P	Ave
CH1	-0.1284	+0.4146	-0.4120	+0.8267	+0.0195
CH2	-0.1981	+0.4160	-1.0823	+1.4983	-0.0144
CH3	-0.154	+0.417	-1.130	+1.547	-0.015
CH4	-0.167	+0.420	-1.129	+1.549	-0.015
CH5	-0.178	+0.428	-1.155	+1.582	-0.013
CH6	-0.19	+0.42	-1.17	+1.60	-0.03
CH7	-0.21	+0.43	-1.15	+1.60	-0.03
CH8	-0.24	+0.53	-1.20	+1.72	-0.03

Analog CH only

CH	VALUE	Max	Min	P-P	Ave
CH1	-0.4025	+0.4151	-0.4120	+0.8271	+0.0008
CH2	-0.3993	+0.4161	-1.0823	+1.4983	-0.0143
CH3	-0.398	+0.417	-1.130	+1.547	-0.015
CH4	-0.394	+0.420	-1.129	+1.549	-0.015
CH5	-0.388	+0.428	-1.155	+1.582	-0.013
CH6	-0.40	+0.42	-1.17	+1.60	-0.03
CH7	-0.42	+0.45	-1.15	+1.60	-0.03
CH8	-0.37	+0.53	-1.20	+1.72	-0.03

Analog CH + Logic CH

CH	VALUE	Max	Min	P-P	Ave
CH1	-0.3506	+0.4151	-0.4120	+0.8271	+0.0008
CH2	-0.3435	+0.4161	-1.0823	+1.4983	-0.0143
CH3	-0.337	+0.417	-1.130	+1.547	-0.015
CH4	-0.333	+0.420	-1.129	+1.549	-0.015
CH5	-0.321	+0.428	-1.155	+1.582	-0.013
CH6	-0.32	+0.42	-1.17	+1.60	-0.03
CH7	-0.31	+0.45	-1.15	+1.60	-0.03
CH8	-0.30	+0.53	-1.20	+1.72	-0.03

Analog CH + Pulse CH

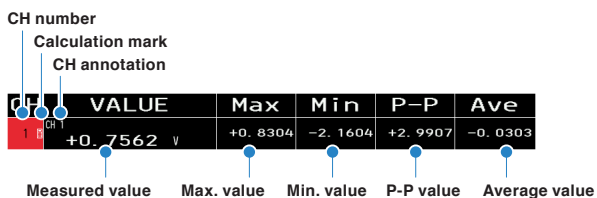

- CH number : Measured CH number.
- Calculation mark : Displayed when calculation between channels is set.
- CH annotation : Annotation set in CH is displayed.
- Measured value : Currently measured value is displayed.

#### <Statistical calculation value>

Use DISP menu, FUNC key and QUIT key to clear the statistical calculation during Free running. Also, the statistical calculation is cleared when the capturing is started.

- Maximum value : Maximum value after clearing
- Minimum value : Minimum value after clearing
- P-P value : P-P value (between maximum value and minimum value)
- Average value : Average value after clearing

### (3) XY waveform display

XY waveform display is a function to display a graph with measured values for both the horizontal X-axis and the vertical Y-axis.

Since the graph is drawn based on measured values of CH set on the horizontal axis and vertical axis, you can check the correlation between both data graphically.

XY waveform display mode has RANGE mode, SPAN mode, POSITION dedicated to XY and VERNIER functions.

You can set it by almost the same operation as the operation of the XY pen recorder

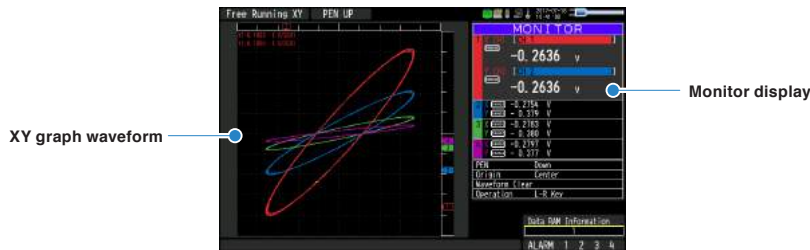

#### RANGE mode/SPAN mode

This device has RANGE mode and SPAN mode.

**RANGE mode:** Switches to the optimum range (amplifier sensitivity) in conjunction with the FS (full scale) range set in the AMP menu.

**SPAN mode:** Sets the span width when using temperature and humidity, EU function, calculation between CHs function.

Refer to the following table to see which mode is set in various settings.

Input	EU	Calculation between CHs	Mode
Voltage	Off	Off	Range
	On	Off	Span
	Off	On	Span
	On	On	Span
Root mean square value	Off	Off	Range
	On	Off	Span
	Off	On	Span
	On	On	Span
Temperature	-	-	Span
Humidity	-	-	Span

The mode that is operating currently is displayed on the monitor display.

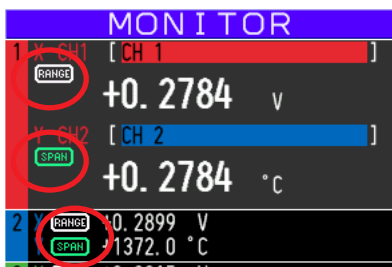

- RANGE : RANGE mode
- SPAN : SPAN mode

The differences in XY monitor operation are as follows.

Mode	RANGE/SPAN	POSITION	VERNIER
RANGE	Use the ◀▶ keys to change the V/DIV range. The V/DIV range cannot be changed during replay.	Position reference point is 0V or 0Vrms.	100 to 50% (40%)
SPAN	Use the ◀▶ keys to change the Span width. The Span width cannot be changed during replay.	Position reference point is the center point of the span.	100 to 40%

In RANGE mode, the relationship between the FS range displayed by the AMP setting and the V/DIV range displayed on the XY monitor is as follows. In addition, the VERNIER setting range in each range is as shown in the following table.

FS range	V/DIV range	Vernier setting range	FS range	V/DIV range	Vernier setting range
20mV	1mV/DIV	100% to 50%	10mVrms	0.5mVrms/DIV	100% to 50%
50mV	2mV/DIV	100% to 40%	25mVrms	1mVrms/DIV	100% to 40%
100mV	5mV/DIV	100% to 50%	50mVrms	2.5mVrms/DIV	100% to 50%
200mV	10mV/DIV	100% to 50%	100mVrms	5mVrms/DIV	100% to 50%
500mV	20mV/DIV	100% to 40%	250mVrms	10mVrms/DIV	100% to 40%
1V	50mV/DIV	100% to 50%	500mVrms	25mVrms/DIV	100% to 50%
2V	100mV/DIV	100% to 50%	1Vrms	50mVrms/DIV	100% to 50%
5V	200mV/DIV	100% to 40%	2.5Vrms	100mVrms/DIV	100% to 40%
10V	500mV/DIV	100% to 50%	5Vrms	250mVrms/DIV	100% to 50%
20V	1V/DIV	100% to 50%	10Vrms	500mVrms/DIV	100% to 50%
50V	2V/DIV	100% to 40%	25Vrms	1Vrms/DIV	100% to 40%
100V	5V/DIV	100% to 50%	50Vrms	2.5Vrms/DIV	100% to 50%
200V	10V/DIV	100% to 50%	100Vrms	5Vrms/DIV	100% to 50%
500V	20V/DIV	100% to 40%	250Vrms	10Vrms/DIV	100% to 40%

Since the RANGE affects the hardware operation (amplifier sensitivity), it cannot be changed during capturing or replaying.

The RANGE setting is common to the RANGE setting of the Y-T graph.

In SPAN mode, the SPAN can be changed within the same range as the Y-T graph.

You can set easily the SPAN in RANGE/SPAN display of XY monitor. In addition, you can change it in detail by AMP menu setting or DISP menu setting.

It is common to span setting of Y-T graph.



## XY position

In the position function of XY graph display (hereinafter XY position), set the drawing position of position reference point to 0% for the lower left corner and 100% for the upper right corner of the XY graph.

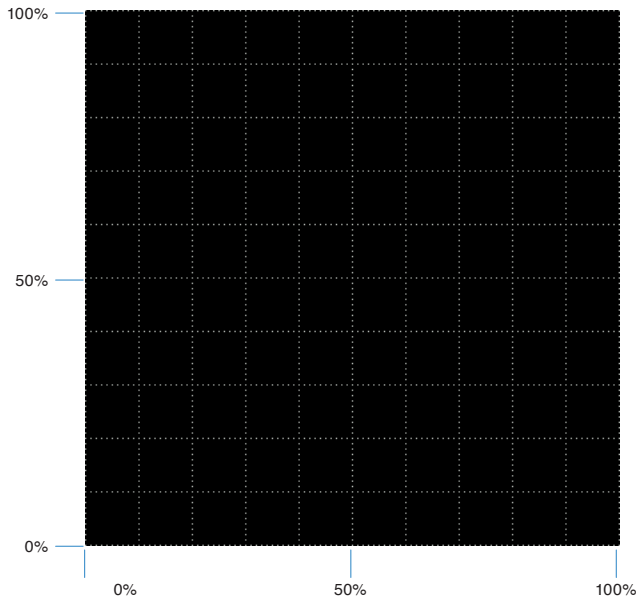

The measurement range displayed on the graph by the XY position setting is as follows.

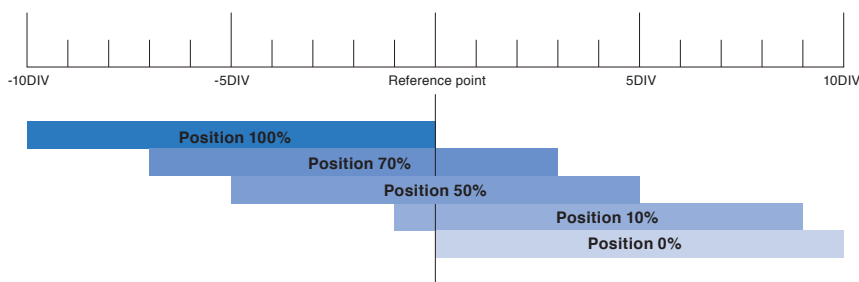

As shown in the above figure, the display range is moved in parallel 10DIV area by XY position setting. XY position setting is used for XY graph setting only.

Position reference point differs between RANGE mode and SPAN mode.

- RANGE mode

The position reference point in RANGE mode is 0V or 0Vrms.

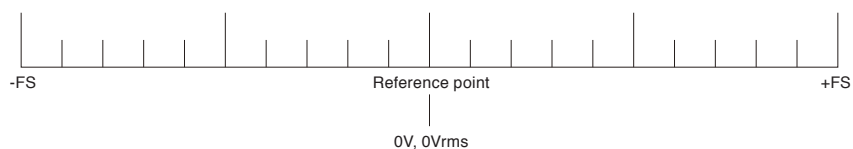

- SPAN mode

The position reference point in SPAN mode is the center point between the upper limit span value and the lower limit span value.

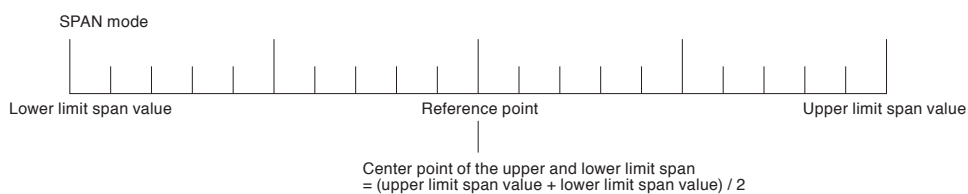

During setting the XY position, a position reference line (pink line) indicating the position reference value is displayed.

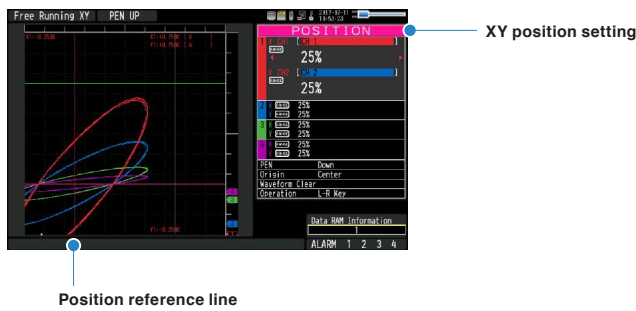

## VERNIER

The VERNIER is a function to adjust the amplitude (gain).

Adjust the display width range of the waveform displayed on the XY graph.

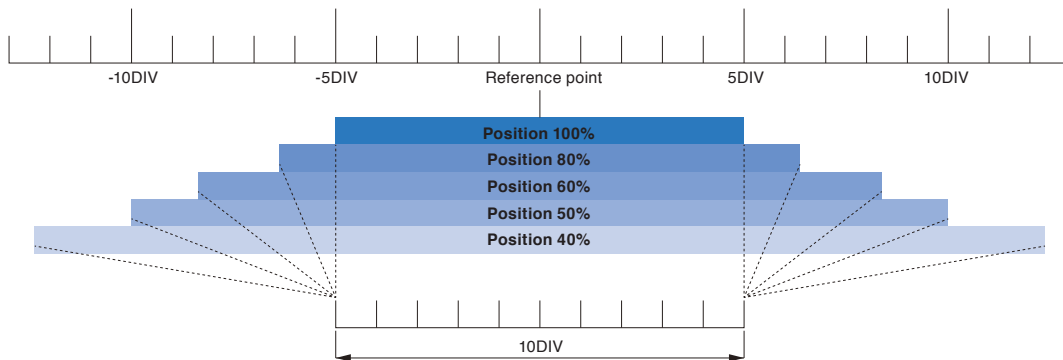

When the VERNIER is set to 100%, it becomes equal magnification. Therefore the waveform display is shrunk by the VERNIER setting magnification.

For example, when the VERNIER is set to 80%, it is displayed with a size of 80% compared with 100%. (The above figure shows the sample when the XY position is set to 50%)

During VERNIER setting, a VERNIER reference line (green line) pointing to the VERNIER magnification is displayed.

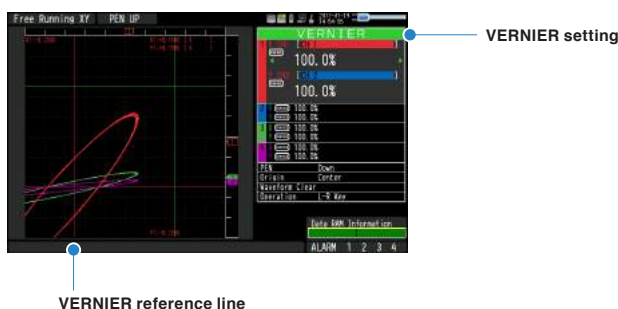

The VERNIER reference line is displayed at the position of 5DIV from the position reference point when the VERNIER is set to 100%. When the VERNIER is set to 80%, it is displayed at the position of 4DIV from the position reference line (80% position compared with 100%).

## XY monitor display



The XY monitor display has the following functions.

- Displaying of the measured value as a digital value.
- Active XY-CH setting.
- RANGE/SPAN/POSITION/VERNIER setting.
- Quick setting

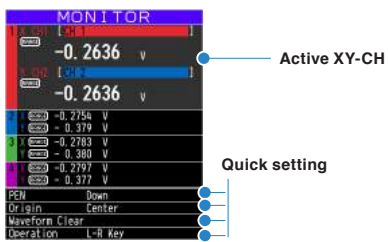

### CAUTION

XY-CH which TRACE is set to Off is not displayed.

## Digital display of measured value

- During Free running/Capturing

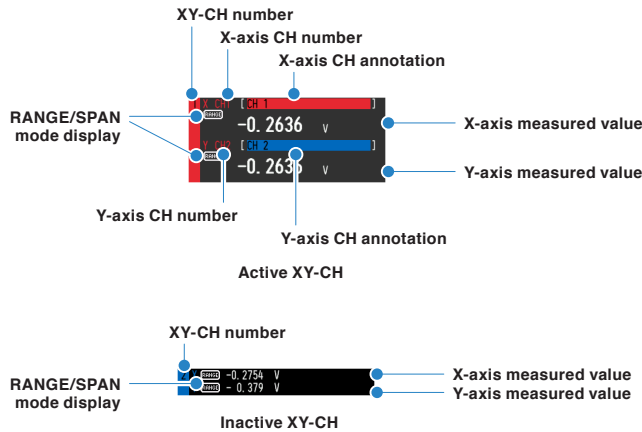

- XY-CH number : XY-CH number.
- RANGE/SPAN mode display : Displayed which the selected CH is operating in RANGE mode or SPAN mode.
- X(Y)-axis CH number : Analog CH number set on the X(Y)-axis.
- X(Y)-axis CH annotation : Annotation of the analog CH set on the X(Y)-axis is displayed. When the number of annotation characters is larger than the display area, all the character strings are displayed by scrolling to the left.
- X(Y)-axis measured value : Currently measured value (instantaneous value) is displayed.

- During replaying

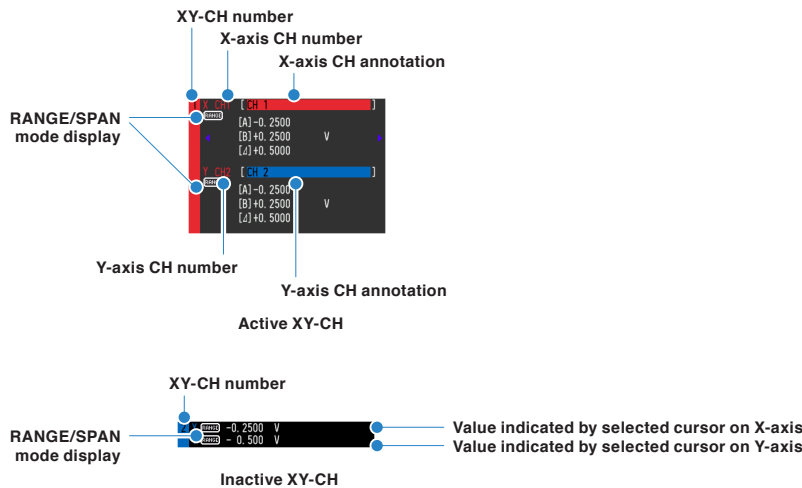

- XY-CH number : XY-CH number
- RANGE/SPAN mode display : Displayed which the selected CH is operating in the RANGE mode or the SPAN mode.
- X(Y)-axis CH number : Analog CH number set to the X(Y)-axis.
- X(Y)-axis CH annotation : Annotation of the analog CH set to the X(Y)-axis is displayed. When the number of annotation characters is larger than the display area, all the character strings are displayed by scrolling to the left.
- X(Y)-axis cursor A (B) indication value : The indication value on the graph indicated by each cursor is displayed.

Difference value between cursor A and B on X(Y)-axis

: Displays the difference of measured values between cursors A and B. When cursor A is selected, B-A value is displayed. When cursor B is selected, A-B value is displayed.

Indication value by selected cursor: The indication value on the graph indicated by the currently selected cursor is displayed.

### L-R key mode and Cross key mode

XY monitor display has 2 operation modes.

2 operation modes are L-R key mode with the same key operation as the Y-T waveform screen and Cross key mode optimized for operation of XY waveform screen.

• L-R key mode

Move XY-CH and axis with the CH SELECT key (hereafter CS key) or the ▲ ▼ keys.

Change the contents of XY-CH and axis selected with the ▲ ▼ keys.

In "MONITOR" display, you can move the XY-CH with the CS key or the ▲ ▼ keys during Free running or capturing. (It is not applied during replaying even in "MONITOR" display.)

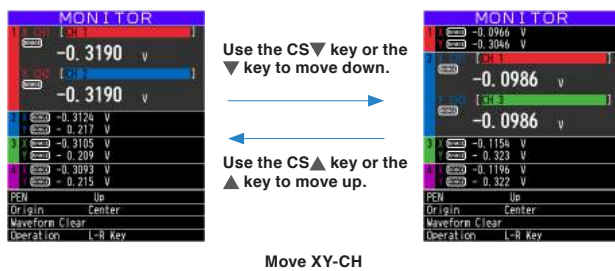

Other than the above, use CS key or the ▲ ▼ keys to move the axis. After that, press the same direction key to move XY-CH.

\* The contents sandwiched between ◀ and ▶ marks in active XY-CH are selected.

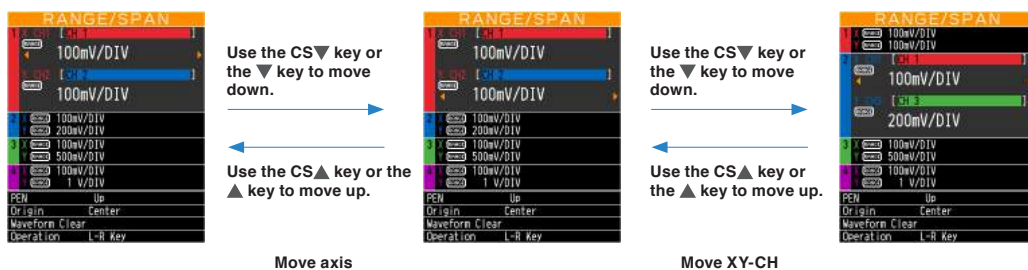

Change the setting contents of XY-CH/axis selected with the ◀ ▶ keys.



In the "MONITOR" display during replaying, the cursor is moved on the selected axis. Move to decreasing direction /left (down) with the ◀ key, and move to increasing direction /right (up) with the ▶ key.

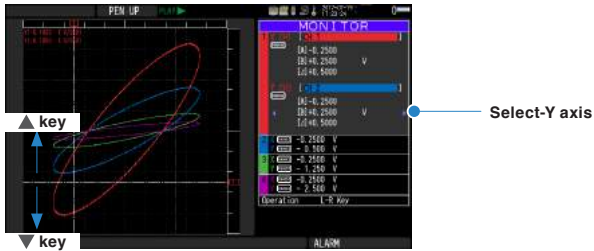

• Cross key mode

Move XY-CH with CH SELECT key (hereafter CS key).

Use the ◀▶ keys to change the contents of the X-axis, and use the ▲ ▼ keys to change the contents of the Y-axis.

(In Quick setting area, use the ◀▶ key to change contents.)

Use CS key to move XY-CH.



Change the setting contents of X-axis for XY-CH selected with the ◀▶ keys.



Change the setting contents of Y-axis for XY-CH selected with the ▲ ▼ keys.



In the "MONITOR" display during replaying, you can move the cursor of the selected XY-CH. Use the ◀ ▶ keys to move the X-axis cursor, and use the ▲ ▼ keys to move the Y-axis cursor.

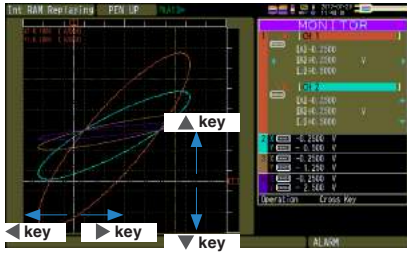

### Simple setting of RANGE/SPAN/POSITION/VERNIER

Press "SPAN/TRACE/POSITION" key to perform each setting.

XT screen

MONITOR	RANGE/SPAN	POSITION	VERNIER
Digital value is display. (Default status)	The RANGE/SPAN value (waveform amplitude) can be changed.	POSITION (center position of waveform) can be changed.	VERNIER (fine amplitude adjustment of waveform) can be changed.

### Quick setting

Quick setting is a function that can set in the Monitor display without opening the setting menu.

- Pen (PEN)



Operate the pen UP/DOWN.

Use the ◀▶ keys to change the state of UP/DOWN.

When the pen is in DOWN state, the trajectory of the pen is drawn in the XY graph waveform.

Pen down operation is forced during capturing.



Pen UP state

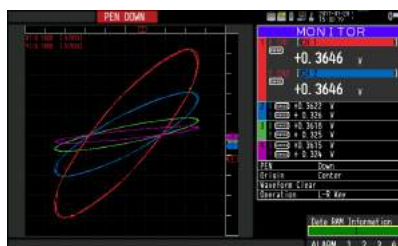

Pen DOWN state

- Origin



Initialize the XY position.

Select the Center of the XY graph or the Lower Left of the XY graph with the ◀▶ keys.

If ENTER key is pressed after selecting it, the XY position reference point moves to the selected position

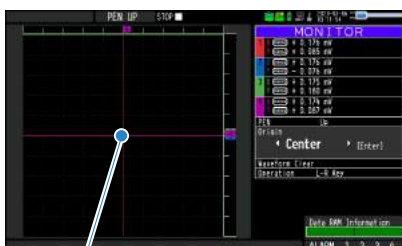

Origin Center



Origin Lower Left



• Waveform Clear

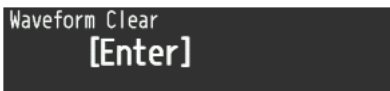

Erase the waveform (pen trajectory) in the XY graph.  
Press [ENTER] key to erase it.

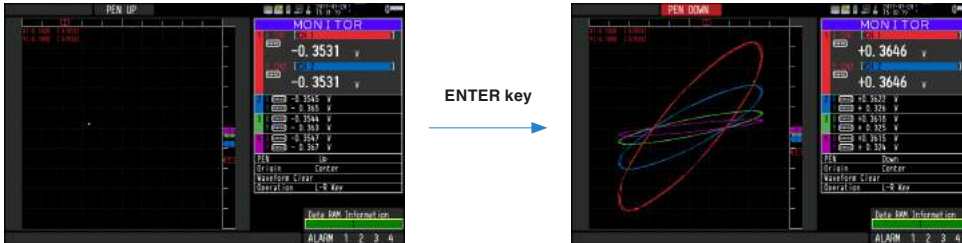

• Operation mode (Operation)



Switch the operation mode of the XY monitor.  
Press the ◀▶ keys to switch the operation mode.

- L-R Key : L-R key mode
- Cross key : Cross key mode

### XY overwrite display

When XY waveform display is used, you can display the saving range from the file menu as "Waveform screen" and the saved image file as the background image of the XY graph.

(Other than the waveform screen image file saved by this device are not available.)

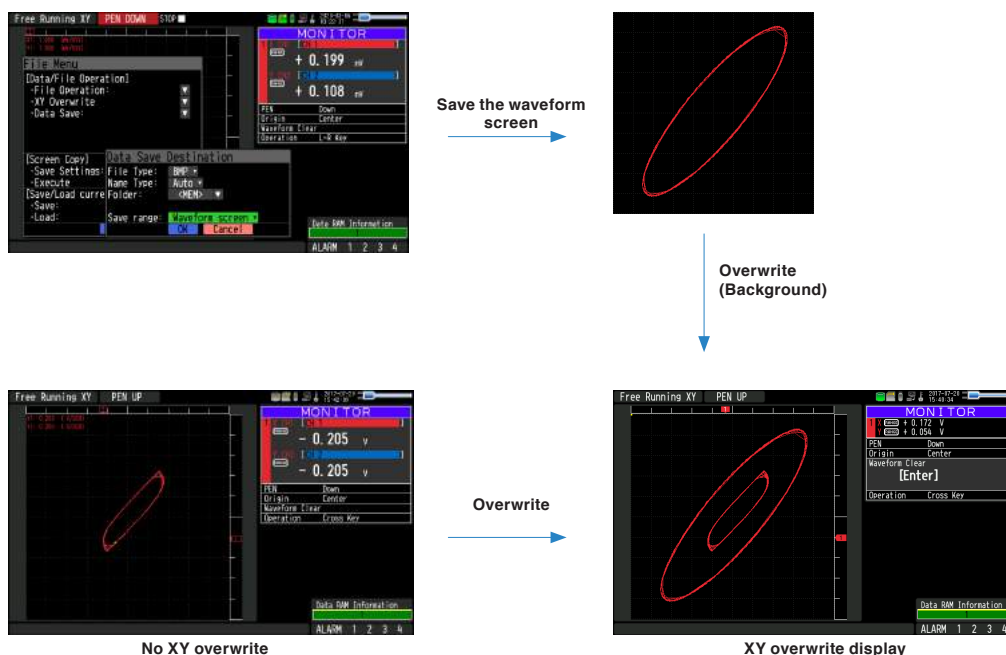

The background image to be overwritten is not erased even if operating the XY display clear.

Perform "Overwrite Clear" separately.

\* It is overwritten even during replaying.

#### CAUTION

Overwrite is a function to read image as image data in the background. Therefore, even if you change the XY position and VERNIER setting etc. for the waveform displayed in the background, it will not be reflected.

For details of XY overwrite setting, refer to "3.5 Setting Menus" - "(3) DISP menu" - "XY overwrite".

### 3.4 Operation Modes

You can check the system operation status in the “Status Message”.

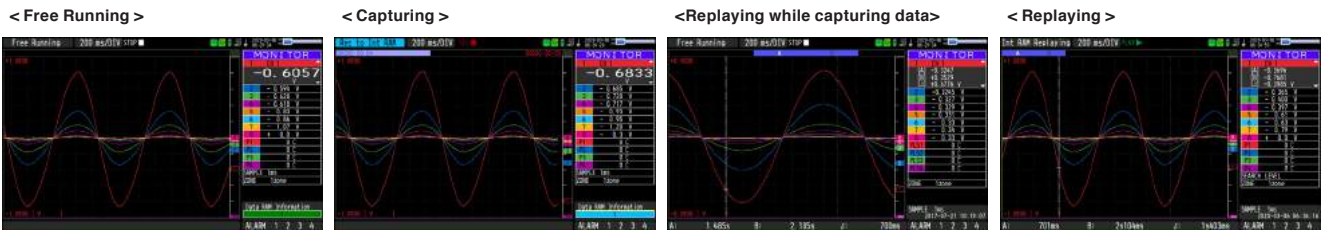

Operation	Description	Simple message display
Free Running	Startup status, or data is not being captured.	Free Running Free Running XY
Capturing	The data is being captured.	Capturing to internal RAM Capturing to internal memory Capturing to SD card Capturing to USB memory
Replaying while capturing data	Data being captured is being replayed.	Capturing and Replaying
Replaying	Captured data is being replayed.	Replaying from internal RAM Replaying from internal memory Replaying from SD card Replaying from USB memory

Operation status transition

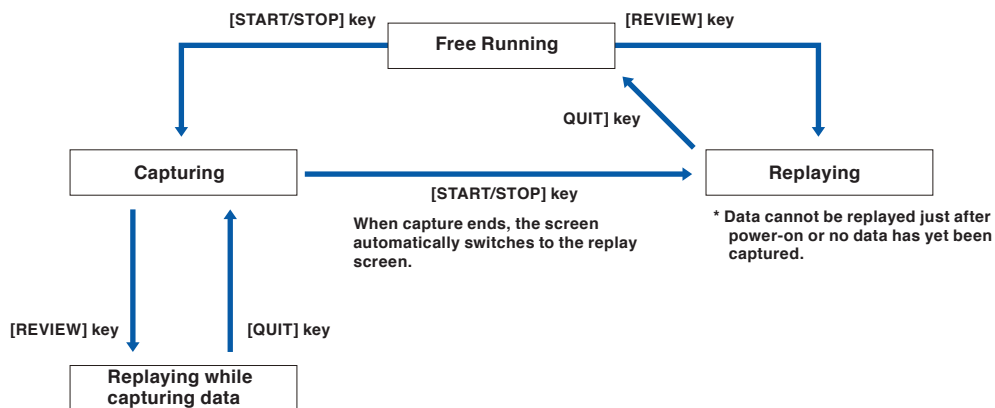

The operation modes are described using the Y-T + Monitor display screen.

The basic operation is the same in other screen modes.

## (1) Free Running

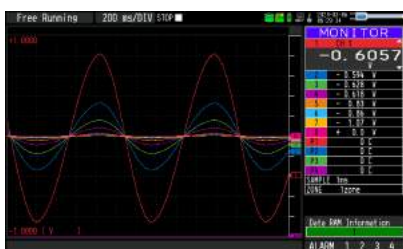

In Free Running, you primarily perform the settings for data capture. You can check the currently input signal in the waveform or digital value.

### Main operations available during Free Running

Measurement condition setting change	The [MENU] key is used to change various setting items in setting menus.
SPAN/TRACE/POSITION change	The [SPAN/TRACE/POSITION] key is used to change settings.
Display mode switch	The [DISPLAY] key is used to change the display mode.
File operations	The [FILE] key is used to perform file-related operations.
Data replay	The [REVIEW] key is used to replay captured data.
Time axis change	The [TIME/DIV] key is used to change the time axis scale.

### Operation of screen display

The information in the screen display is changed by switching the channel.

The operation of screen display can be performed during Free Running, capturing, and replaying.

<Screen display when the CH1 is selected on the MONITOR screen during Free Running>

The scale of the selected channel is indicated.

The display channel can be switched by the ▲▼ keys.

The selected channel is displayed without coloration.

## (2) Capturing

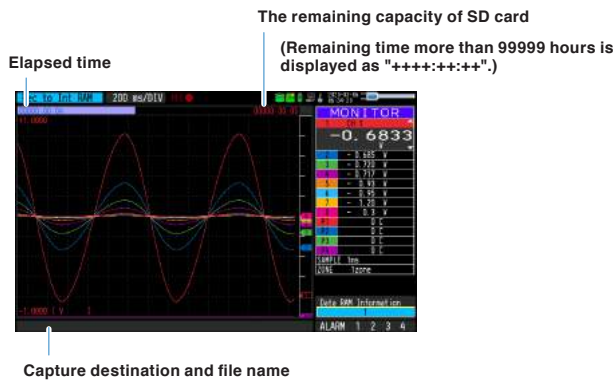

The captured data is saved in the Internal RAM, internal memory, SD card or USB memory during data capture.

You cannot use the [MENU] key to change the setting.

### Operations available during capture

SPAN/TRACE/POSITION change	Change the settings with the [SPAN/TRACE/POSITION] key.
Screen display mode switch	Change the screen mode with the [DISPLAY] key.
Replay while capturing	Replay the data captured while capturing
Save to device	Save to the device with the [FILE] key during data capture.
Setting check	Display the setting information with the [MENU] key.
Time axis change	Change the time axis with the [TIME/DIV] key.

## (3) Data replaying during capturing

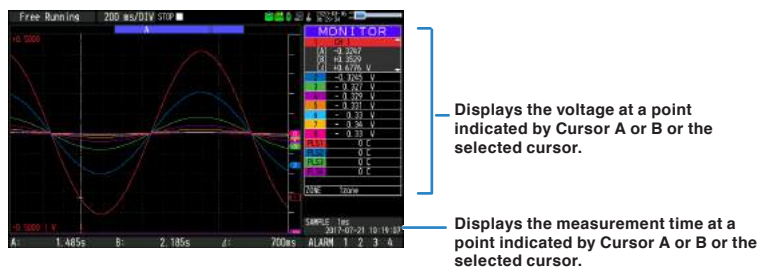

The captured data while capturing can be replayed by pressing the [REVIEW] key.

Use the Direction keys (◀▶) to move the cursor and captured data to check digital values.

### Operations available during capturing

Cursor movement	The [CURSOR] key is used to switch between cursors A and B. The ◀▶ or ◀◀, ▶▶ keys are used to move the cursors.
Save to device	The save to the device can be performed from the [FILE] menu. (The data up to the present or between the cursors can be saved in a separate file during data capture.)
Screen copy	Copy the screen with the [FILE] key.
Time axis change	Change the time axis with the [TIME/DIV] key.

### (4) Replaying

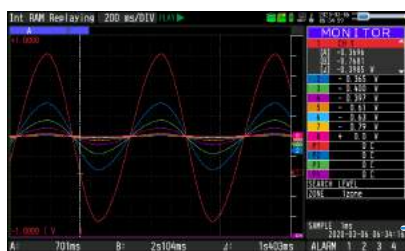

Displays the voltage at a point indicated by Cursor A or B or the selected cursor.

Displays the measurement time at a point indicated by Cursor A or B or the selected cursor.

Displays the captured data.

#### Main operations available during replaying

SPAN/TRACE/POSITION change	Change the settings with the [SPAN/TRACE/POSITION] key.
Operation in the menu during data capture	Perform cursor movement, data search and calculation setting with the [MENU] key.
Cursor movement	Switch between Cursor A and B with the [CURSOR] key. Using the ◀▶ or ◀◀, ▶▶ keys, move the cursor.
Data save	Save all the data or data between cursors with the [FILE] key.
Time axis change	Change the time axis scale with the [TIME/DIV] key.
File operation	Perform file-related operations
Display copy	Copy the screen with the [FILE] key.

#### ⚠ CAUTION

For CSV-formatted data, only the data captured by this device can be replayed.

Also, when the data captured in CSV format is replayed, the unit of the temperature data is displayed in “deg C” rather than “°C”.

## 3.5 Setting Menus

When you press the [MENU] key during Free Running, the following menu screens appear.

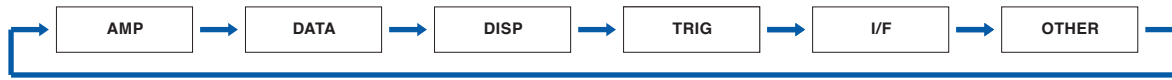

### (1) AMP settings

This menu is used to specify input signal-related settings.



#### < Analog settings >

Setting		Selections available		
Input		Off, DC, RMS, TEMP, RH		
Range	[Voltage]	20, 50, 100, 200, 500mV; 1, 2, 5, 10, 20, 50, 100, 200, 500V; 1-5V		
	[RMS]	10, 25, 50, 100, 250, 500mVrms 1, 2.5, 5, 10, 25, 50, 100, 250Vrms		
	[Temperature]	TC-K, TC-J, TC-T, TC-R, TC-E, TC-B, TC-S, TC-N, TC-W		
	[Humidity]	100% fixed		
Filter		Line, 5, 50, 500Hz, 5, 50kHz		
EU (Scaling settings)	Function	Off, On		
	Dec pt	None, 1 digit, 2 digits, 3 digits, 4 digits after the decimal point		
	Meas. Value	Upper limit	Set numeric value.	
		Lower limit	Set numeric value.	
	EU value	Upper limit	Set numeric value.	
		Lower limit	Set numeric value.	
Select	Cur, Length, Area, Volume, Velocity, Accel, Freq, Mass, Energy, Pressure, Flow, Temp, Strain, Brightness, Concentration; Optional			
Unit	(The selections vary depending on the unit selected in the above.)			
Misc.	Annotation text string	Enter text. (Max. 31 characters)		
	Inter-CH Op Settings	Function	Off, On	
		Operation	Left-hand side	CH number
			Operator	+, -, x, /
		Righthand side	CH number	
	Scaling	/1000000, /1000, x1, x1000, x1000000		
	Operations span	Dec pt	x1, x10, x100, x1000, x10000	
		Upper limit	Set numeric value.	
	Lower limit	Set numeric value.		
	Select	Cur, Length, Area, Volume, Velocity, Accel, Freq, Mass, Energy, Pressure, Flow, Temp, Strain, Brightness, Concentration; Optional		
	Unit	The selections vary depending on the unit selected in the above. (Enter arbitrary text: Up to 8 characters)		
	Span settings	Upper limit	Set numeric value.	
		Lower limit	Set numeric value.	
	Set waveform color	0 to 31 for each of red, green, blue (RGB)		
	Line Thickness Setting	1 to 8 dots		
	Trace	Off, On		

Setting		Selections available	
Misc.	[DC, RH]	Perform Auto Zero ADJ.	▶ Press right key to execute.
		Reset Auto Zero ADJ.	▶ Press right key to execute.
	[TEMP]	RMS value operation cross value	Set numeric value.
		Reads the current voltage meas. value	▶ Press right key to execute.
		Cross value reset	▶ Press right key to execute.
	[RH]	Burnout check	▶ Press right key to execute.

<Logic/Pulse settings>

Setting		Selections available			
Logic/Pulse		Off, Logic, Pulse			
Logic/Pulse	[Logic]	Filter	Off, On		
		Misc.	Annotation text string	Enter text. (Max. 31 characters)	
			Set waveform color	0 to 31 for each of red, green, blue (RGB)	
			Trace	Off, On	
	[Pulse]	Input	Off, Revolution counts, Counts, Inst.		
		Filter	Off, On		
		Slope	H, L		
		EU	Function	Off, On	
			Meas. Value	Set numeric value.	
			EU value	Set numeric value.	
			Select	Cur, Length, Area, Volume, Velocity, Accel, Freq, Mass, Energy, Pressure, Flow, Temp, Strain, Brightness, Concentration; Optional	
			Unit	The selections vary depending on the unit selected in the above. (Enter arbitrary text: Up to 8 characters)	
			Arbitrary unit	Enter text.	
		Misc.	Annotation text string	Enter text. (Max. 31 characters)	
			Span Set-tings		Set numeric value.
				Lower limit	Set numeric value.
			Set waveform color	0 to 31 for each of red, green, blue (RGB)	
	Line Thickness Setting		1 to 8 dots		
	Trace		Off, On		
	Pulses per revolution		1 to 10000		



## Analog settings

Specifies the conditions for analog signals.

### CHECKPOINT

When you use CH ALL to set an input, range, filter and EU, all channels are set to the same values if the input is the same. Range is set only for the same input channels. However, the range of a channel is not changed if its EU (scaling) is set to On.

CH ALL - Misc. - Span Settings is set only for the same range channels.

### (1)-1 Input

Select input conditions.

Selection item	Description
Off	Input signal measurement is disabled. No waveform or digital value is displayed.
DC	Used for measuring direct-current voltage.
RMS	Used to measure the RMS of AC voltage.
TEMP	Used for measuring temperature.
RH	Used for measuring humidity with the humidity sensor B-530. In this case, the voltage range will become 1 V, and the EU settings will not be available

\* Enter DC-RMS as the effective value (RMS).

### (1)-2 Range

Select the range to measure.

Input item	Description
DC	20, 50, 100, 200, 500 mV, 1, 2, 5, 10, 20, 50, 100, 200, 500 V, 1-5 V
RMS	10, 25, 50, 100, 250, 500 mVrms 1, 2.5, 5, 10, 25, 50, 100, 250 Vrms (500, 1000 Vrms)
TEMP	TC-K, TC-J, TC-T, TC-R, TC-E, TC-B, TC-S, TC-N, TC-W
RH	100% fixed

Available SPAN Settings

< Voltage Ranges >

Range	Maximum SPAN	Minimum SPAN	Minimum Resolution
20mV	-22.000 to +22.000mV	0.200mV	0.001mV
50mV	-55.00 to +55.00mV	0.50mV	0.01mV
100mV	-110.00 to +110.00mV	1.00mV	0.01mV
200mV	-220.00 to +220.00mV	2.00mV	0.01mV
500mV	-550.0 to +550.0mV	5.0mV	0.1mV
1V	-1.1000 to +1.1000V	0.0100V	0.0001V
2V	-2.2000 to +2.2000V	0.0200V	0.0001V
5V	-5.500 to +5.500V	0.050V	0.001V
10V	-11.000 to +11.000V	0.100V	0.001V
20V	-22.000 to +22.000V	0.200V	0.001V
50V	-55.00 to +55.00V	0.50V	0.01V
100V	-110.00 to +110.00V	1.000V	0.01V
200V	-22.000 to +22.000V	2.0V	0.01V
500V	-550.00 to +550.00V	5.0V	0.01V
1-5V	-5.500 to +5.500V	0.050V	0.001V

<Effective value (RMS) range>

Range	Maximum SPAN	Minimum SPAN	Minimum Resolution
10mVrms	-11.000 to +11.000mVrms	0.1mVrms	0.001mVrms
25mVrms	-27.500 to +27.500mVrms	0.25mVrms	0.001mVrms
50mVrms	-55.00 to +55.00mVrms	0.5mVrms	0.001mVrms
100mVrms	-110.00 to +110.00mVrms	1mVrms	0.01mVrms
250mVrms	-275.00 to +275.00mVrms	2.5mVrms	0.01mVrms
500mVrms	-550.0 to +550.0mVrms	5mVrms	0.01mVrms
1Vrms	-1.1000 to +1.1000Vrms	0.010Vrms	0.0001Vrms
2Vrms	-2.7500 to +2.7500Vrms	0.025Vrms	0.0001Vrms
5Vrms	-5.500 to +5.500Vrms	0.050Vrms	0.0001Vrms
10Vrms	-11.000 to +11.000Vrms	0.100Vrms	0.001Vrms
25Vrms	-27.500 to +27.500Vrms	0.250Vrms	0.001Vrms
50Vrms	-55.00 to +55.00Vrms	0.500Vrms	0.001Vrms
100Vrms	-110.00 to +110.00Vrms	1.00Vrms	0.01Vrms
250Vrms	-275.00 to +275.00Vrms	2.50Vrms	0.01Vrms

< Temperature Ranges > : Celsius

Range	Maximum SPAN	Minimum SPAN (p-p)	Measurable Range	Minimum Resolution
K	-273 to +2000°C	10°C	-200 to +1370°C	0.1°C
J	-273 to +2000°C	10°C	-200 to +1100°C	
T	-273 to +2000°C	10°C	-200 to +400°C	
R	-273 to +2000°C	10°C	0 to +1600°C	
E	-273 to +2000°C	10°C	-200 to +800°C	
B	-273 to +2000°C	10°C	+600 to +1820°C	
S	-273 to +2000°C	10°C	0 to +1760°C	
N	-273 to +2000°C	10°C	0 to +1300°C	
W	-273 to +2000°C	10°C	0 to +2000°C	

< Temperature Ranges > : Fahrenheit

Range	Maximum SPAN	Minimum SPAN (p-p)	Measurable Range	Minimum Resolution
K	-459 to +3000°F	10°F	-328 to +2498°F	0.18°F
J	-459 to +3000°F	10°F	-328 to +2012°F	
T	-459 to +3000°F	10°F	-328 to +752°F	
R	-459 to +3000°F	10°F	-32 to +2912°F	
E	-459 to +3000°F	10°F	-328 to +1472°F	
B	-459 to +3000°F	10°F	+1112 to +3000°F	
S	-459 to +3000°F	10°F	-32 to +3000°F	
N	-459 to +3000°F	10°F	-32 to +2372°F	
W	-459 to +3000°F	10°F	-32 to +3000°F	

< Humidity Range >

Range	Maximum SPAN	Minimum SPAN (p-p)	Minimum Resolution
	0 to +110%	0.1%	0.1%

**(1)-3 Filter**

Selects the range to be measured.

Selection item	Description
Off	Filter is not used.
Line	Cutoff frequency is 1.5 Hz.
5Hz	Cutoff frequency is 5 Hz.
50Hz	Cutoff frequency is 50 Hz.
500Hz	Cutoff frequency is 500 Hz.
5kHz	Cutoff frequency is 5 kHz.
50kHz	Cutoff frequency is 50 kHz.

**(1)-4 EU (Scaling settings)**

This is used to convert the measured signals to other units.

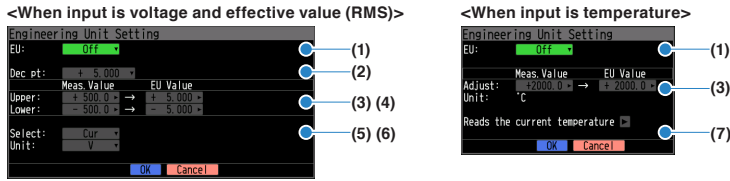

Setting	Description
(1) EU	Set the scaling function to ON or OFF.
(2) Dec pt	Set the decimal point position for an EU value.
(3) Meas. Value (Upper/Lower)	Set the upper and lower limits of values to be converted. * For temperature input, there is no distinction between upper and lower limits. See the setting examples shown below for details.
(4) EU Value (Upper/Lower)	Set the upper and lower limits of values to be converted. * For temperature input, there is no distinction between upper and lower limits. See the setting examples shown below for details.
(5) Select	Select a specific engineering unit classification. (The following are available.) Cur, Length, Area, Volume, Velocity, Accel, Freq, Mass, Energy, Pressure, Flow, Temp, Strain, Brightness, Concentration; Optional You can enter arbitrary units by selecting Arbitrary.
(6) Unit	Select a unit to be used after conversion. A unit displayed in this field belongs to the classification selected in "Select". To set a unit not displayed in this field, set arbitrary text in "Arbitrary unit." The setting selected in this field is displayed in "Arbitrary unit." (Number of characters that can be entered: Up to 8 characters)
(7) Reads the current temperature	Substitute the currently measured value into (3) Meas. Value and (4) EU Value. * The value is not substituted when burnout occurs or the scale is exceeded.

**CHECKPOINT**

- If a message window opens, follow the instruction in the message to change the setting value.
- The Scaling function performs calculation using a ratio of the Meas. Value and EU Value settings. The digital display shows “++++/----” when the converted value cannot be processed by this device.
- The span may be changed depending on the Scaling settings.
- For temperature input, the offset setting for an input value is used.

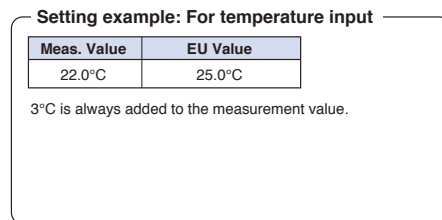
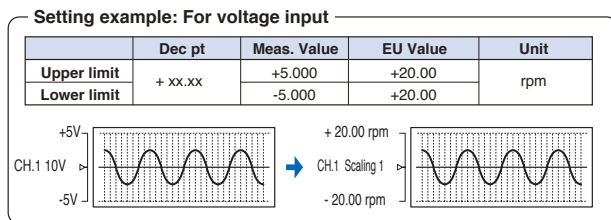

(1)-5 Other settings

< Voltage/Humidity >

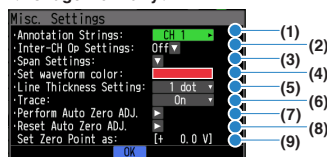

< Effective value (RMS) >

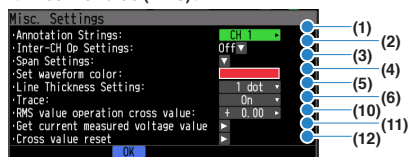

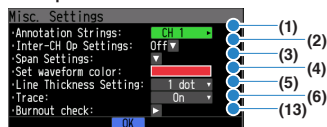

< Temperature >

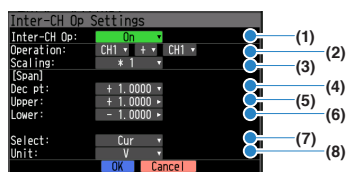

Setting object	Setting	Description
DC RMS TEMP RH	(1) Annotation Settings	Set the annotation (comment) displayed in the CH.
	(2) Inter-CH Op Settings	Set what to do in calculation between channels. Four arithmetic operations (+, -, x, ÷) can be set as calculation between channels.
	(3) Span Settings	Set the upper limit of the span displayed in the Y-T waveform.
	(4) Set waveform color	Set the display color of each CH. 0 to 31 for each of red, green, blue (RGB)
	(5) Line Thickness Setting	Set the line thickness (1 to 8 dots).
	(6) Trace	Set the waveform display to On or Off.
DC RH	(7) Perform Auto Zero ADJ.	The current input voltage (RH) is calculated as a zero point voltage value (zero point RH value).
	(8) Reset Auto Zero ADJ.	Reset the zero point voltage value (zero point RH value).
	(9) Set Zero Point as	The zero point voltage value (zero point RH value) is displayed.
RMS	(10) RMS value operation cross value	Set the voltage which is the ± cross value for performing the RMS operation.
	(11) Get current measured voltage value	The RMS operation cross value of (10) is calculated automatically from the current input waveform.
	(12) Cross value reset	Reset the RMS operation cross value. (Set to 0V.)
RH	(13) Burnout check	Check the disconnection of the thermocouple.

Calculation between CHs settings



Setting	Description
(1) Inter-CH Op	Off, On If this setting is ON, the channel has a calculation mark in the digital display, etc. <b>Calculation mark</b> 
(2) Operation	Set the calculation formula. Set right-hand side CH, left-hand side CH and operator. The result of calculation is reflected in the set CH.  Right-hand side CH (Operator) Left-hand side CH Right-hand side CH, Left-hand side CH: CH1 to CH8 Operator: +, -, x, /  The values assigned to the right-hand side CH and left-hand side CH are the measured values before the calculation. You cannot substitute the value after calculation.  CH-X (Function) CH-Y

Setting	Description								
(3) Scaling	<p>Set the scaling factor for a calculation result. /1000000, /1000, x1, x1000, x1000000</p> <p>&lt;Example&gt;</p> <table border="1"> <tr> <td>In the case of calculation result = 0.001</td> <td>In the case of calculation result = 1000</td> </tr> <tr> <td>Calculation result x1 = 0.001</td> <td>Calculation result x1 = 1000</td> </tr> <tr> <td>Calculation result x1000 = 1</td> <td>Calculation result / 1000 = 1</td> </tr> <tr> <td>Calculation result x1000000 = 1000</td> <td>Calculation result / 1000000 = 0.001</td> </tr> </table>	In the case of calculation result = 0.001	In the case of calculation result = 1000	Calculation result x1 = 0.001	Calculation result x1 = 1000	Calculation result x1000 = 1	Calculation result / 1000 = 1	Calculation result x1000000 = 1000	Calculation result / 1000000 = 0.001
In the case of calculation result = 0.001	In the case of calculation result = 1000								
Calculation result x1 = 0.001	Calculation result x1 = 1000								
Calculation result x1000 = 1	Calculation result / 1000 = 1								
Calculation result x1000000 = 1000	Calculation result / 1000000 = 0.001								
Span									
(4) Dec pt	Set the upper and lower limits of values to be converted. * For temperature input, there is no distinction between upper and lower limits. See the setting examples shown below for details.								
(5) Upper (6) Lower	Set the upper limit and lower limit of the span displayed in the Y-T waveform. This setting is for calculation only. When Operation is On, this span is used instead of the span that set in [AMP] - [Misc.] - [Span setting].								
(7) Select	Select a specific engineering unit classification. (The following are available.) Cur, Length, Area, Volume, Velocity, Accel, Freq, Mass, Energy, Pressure, Flow, Temp, Strain, Brightness, Concentration; Optional								
(8) Unit	Select a unit to be used after conversion. A unit displayed in this field belongs to the classification selected in "Select". To set a unit not displayed in this field, set arbitrary text in "Arbitrary unit." The setting selected in this field is displayed in "Arbitrary unit". (Number of characters that can be entered: Up to 8characters)								

**CHECKPOINT**

When EU is set to OFF, m (milli) or k (kilo), etc. of engineering unit is taken into account in the calculation. For example, 100 mV is treated as 0.1.

When EU is set to ON, the engineering unit set in the EU character string is not taken into account. The numerical value of the EU calculation result is the calculated numerical value.

**Span settings**

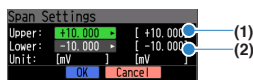

Setting	Description
(1) Upper	Set the upper limit of the span displayed in the Y-T waveform. When EU setting is On, set the EU-converted value. (Numbers in [] are numbers before EU conversion.)
(2) Lower	Set the lower limit of the span displayed in the Y-T waveform. When EU setting is On, set the EU-converted value. (Numbers in [] are numbers before EU conversion.)

**Set waveform color**

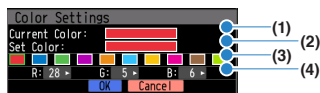

Setting	Description
(1) Current Color	The currently set color is displayed.
(2) Set Color	The color to set from now is displayed.
(3) Preset Color	These are preset colors. You can select from them.
(4) R (red), G (green), B (blue)	Set to 0 to 31 for each of red, green, blue (RGB) If there is not the color you want to use in the preset colors, please use this.

**Zero adjustment function**

Zero adjustment is a function to forcibly cancel the offset of measured value with offset.

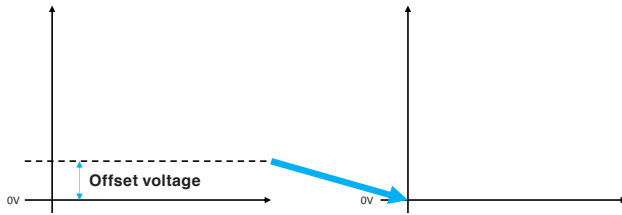

For example, when the offset voltage is +1V, if +1V is actually input, the device measures +1V as 0V.



Setting	Description
(1) Perform Auto Zero ADJ.	The current input voltage (RH) is set to the zero point voltage value (zero point RH value) as a offset voltage value (offset RH value).
(2) Reset Auto Zero ADJ.	The zero point voltage value (zero point RH value) is reset.
(3) Set Zero Point as	The zero point voltage value (zero point RH value) is displayed. When the voltage value (RH value) displayed in this field is input, it is measured as 0 V (0%).

**Effective value (RMS) calculation and cross voltage value**

The effective value (RMS) of this device is obtained by calculation from the measured value.

If the input is an ideal sine wave, the effective value (RMS) is  $1/\sqrt{2}$  of the maximum value.

In this case, it is equivalent to the area centered at 0V.

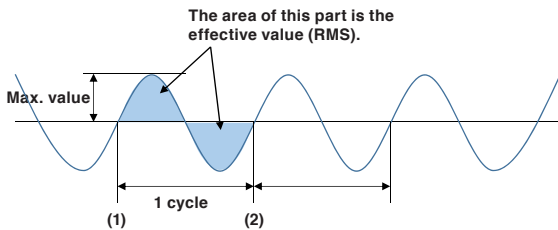

In actual power measurement, it may be a distorted waveform rather than an ideal sinusoidal waveform as shown in the above figure, or there may be an offset in some cases.

Therefore, this device calculates the effective value (RMS) by calculating from the actual measurement value.

To calculate the effective value (RMS), it is necessary to detect one cycle of a sinusoidal wave.

If it is an ideal sinusoidal wave, it should be one cycle between points crossing from 0V in a certain direction. (It is the point of (1) and (2) in the above figure)

The voltage value for detecting one cycle of a sinusoidal wave is called a cross voltage.



If there is an offset in the sinusoidal wave, the cross voltage deviates from the center of the sine wave as shown in the figure below.

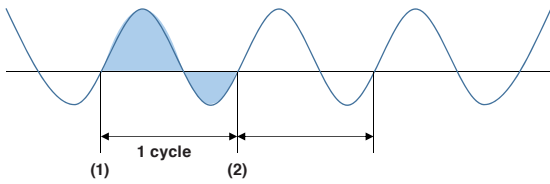

In this case, the area of the actual filled part becomes a larger value than the area of the ideal sine wave. Therefore, the correct effective value (RMS) cannot be calculated.

To solve this problem, you can specify the cross voltage value in this device.

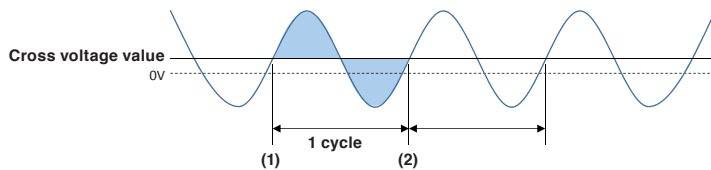

By specifying the cross voltage value, you can more accurately calculate the effective value (RMS).



Setting	Description
(1) RMS value operation cross value	Set the voltage which is the $\pm$ cross value for performing the RMS operation.
(2) Get current measured voltage value	The RMS operation cross value of (1) is calculated automatically from the current input waveform.
(3) Cross value reset	Reset the RMS operation cross value. (Set to 0V.)

\* When read from the currently measured voltage value, calculate it after the input to be measured actually.

### Burnout check

Burnout refers to a state where the thermocouple is disconnected.

Check burnout of CH which input is set to temperature.

Since this device cannot detect burnout and measure at the same time, check whether or not burnout has occurred when measurement is not performed.

Please be aware that the measured value is not accurate when burnout is being detected.

## Logic and Pulse settings

Makes settings related to digital input.

< Pulse setting >

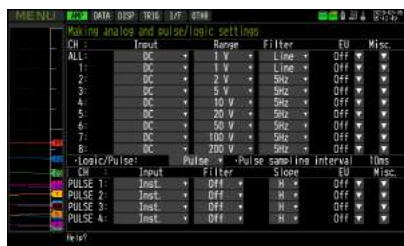

< Logic setting >



### (1)-6 Logic/Pulse

This is used to select the processing method for digital input.

Selection item	Description
Off	Digital input measurement is disabled.
Logic	Digital input is processed as logic signals.
Pulse	Digital input is processed as pulse signals.

\* When pulse input is selected, the sampling interval for pulse is displayed. For details of sampling intervals for pulse, refer to "3.5 Setting Menus" - "(2) DATA setting" - "Sampling interval".

### (1)-7 Input

This is used to set the pulse measurement mode. This setting is available only if Pulse is selected in (1)-6.

Selection item	Description
Off	Pulse input measurement is disabled.
Revol.	The number of pulses per sample interval is counted and converted to the number of revolutions per minute.
Counts	Captures the cumulative number of pulses for each sampling interval from the start of measurement.
Inst.	Captures the number of pulses for each sampling interval.

### (1)-8 Filter

This is used to set the filter for input.

Selection item	Description
Off	Disables hardware filter.
On	Enables hardware filter. It is effective in a noisy environment. The filter is approximately 30 Hz (-3 dB).

**(1)-9 Slope**

This is used to set the slope (direction) to count the number of pulses. This setting is available only if Pulse is selected in (1)-6.

Selection item	Description
↑ H	Counts the rising edges of pulses.
↓ L	Counts the falling edges of pulses.

**(1)-10 EU (scaling settings)**

The measured signal is converted with the engineering unit. This item can be set only when pulse is selected in (1)-6.

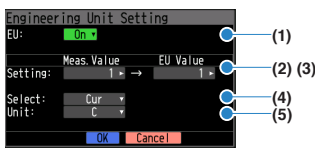

Setting	Description
(1) EU	Set the scaling function to ON or OFF.
(2) Meas. Value	Set a value to be converted.
(3) EU Value	Set an output value after conversion.
(4) Select	Select a specific engineering unit classification. (The following are available.) Cur, Length, Area, Volume, Velocity, Accel, Freq, Mass, Energy, Pressure, Flow, Temp, Strain, Brightness, Concentration; Optional You can enter arbitrary units by selecting Arbitrary.
(5) Unit	Select a unit to be used after conversion. A unit displayed in this field belongs to the classification selected in "Select". To set a unit not displayed in this field, set arbitrary text in "Arbitrary unit". The setting selected in this field is displayed in "Arbitrary unit". (Number of characters that can be entered: Up to 8characters)

**CHECKPOINT**

- If a message window opens, follow the instruction in the message to change the setting value.
- The Scaling function performs calculation using a ratio of the Meas. Value and EU Output Value settings.
- The digital display shows “++++/----” when the converted value cannot be processed by this device.
- The span may be varied depending on the scaling settings.

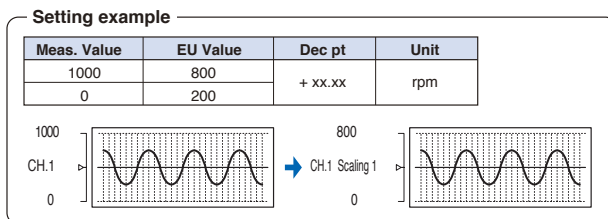

**(1)-11 Misc.**

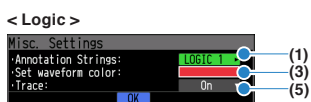

Setting	Description
(1) Annotation Settings	Set the annotation (comment) displayed in the CH.
(2) Span Settings	Set the upper and lower limits of the span displayed in the Y-T waveform. (Pulse only) * When Pulse input is Integration, it is in the auto span state and can not be set.
(3) Set waveform color	Set the display color of each CH. 0 to 31 for each of red, green, blue (RGB)
(4) Line Thickness Setting	Set the line thickness (1 to 8 dots). (Pulse only)
(5) Trace	Set the waveform display to On or Off.
(6) Pulses per revolution	1 to 10000 When the pulse input is set to Pulses per revolution, set the number of pulses per revolution. The number of revolutions per minute (RPM) is calculated, assuming that the number of pulses set here is one revolution. When 100 is set, and then 100 pulses are input, it is 1 revolution when 100 pulses have been input.  <Calculation formula> Number of revolutions (RPM) = Pulse input frequency ÷ Number of pulses per revolution x 60 (1 minute)  <Example> Number of pulses per revolution: 100 (1 rotation is judged when 100 pulses have been input.) Pulse input: 1000 Hz (1000 pulses per sec.) Number of revolutions: 600 RPM (600 RPM per min.)
(7) Integration clear (all CH)	Clear (set to 0) the integrated value of the pulse CH that is set to the Integration input. (Pulse only)

## (2) DATA settings

Set items related to capturing.

< When the capturing destination is internal RAM >



< When the capturing destination is internal memory, SD card, USB memory >



Setting		Selections available
Sampling		Set the main sampling. (1, 2, 5, 10, 20, 50, 100, 200, 500 $\mu$ s) 1, 2, 5, 10, 20, 50, 100, 200, 500 ms 1, 2, 5, 10, 20, 30 s, 1 min, External * The setting range varies depending on the capturing destination. You can select the values in parentheses only when the internal RAM is set.
Pulse sampling intervals		Set the Pulse sampling intervals. (10, 20, 50, 100, 200, 500 $\mu$ s) 1, 2, 5, 10, 20, 50, 100, 200, 500 ms 1, 2, 5, 10, 20, 30 s 1, 2, 5, 10, 20, 30 min, 1 hour * The setting range varies depending on the capturing destination. You can select the values in parentheses only when the internal RAM is set.
Capture des.		Set the data capturing destination. Internal RAM, internal memory, SD card, USB memory
[Internal memory]	Memory block division	Set the memory division. No division, 2-division, 4-division, 8-division
	Block status	The memory block usage state is displayed.
	Overwrite mode	Set the overwrite mode of the data in the internal memory. Off, On
	Internal RAM clear	The data captured to the internal RAM is erased.
	Data pts.	Set the number of data to be captured to the internal RAM. 10 to 4000000 * The setting range varies depending on memory block division.
	Ring recording	Set the ring capturing. Off, On
	Auto Save	Set the auto save. Off, On
	File Name	Set the auto saving destination. * Refer to the following "Capture des.: FileName".
[Internal Memory] [SD card] [USB memory]	Capture des.: FileName	Set the saving destination of captured data. * Refer to the following "Capture des.: FileName".
	Capture des.: Ring/Relay capture	Set the ring capture/relay capture. Off, Ring, Relay
	Backup Intervals	Set the backup interval. Off, 1 hour, 2 hours, 6 hours, 12 hours, 24 hours
	Backup Destination	Set the backup destination. Internal memory, SD card, USB memory
	Save Folder	Set the saving folder and the path of the backup destination.

### Capturing destination file name

Setting		Selections available
File Type		Set the saving format of data file. GBD, CSV
Name Type		Set the file naming method. Automatic, Arbitrary, Sequential number
[Auto]	Folder	Set the folder of the auto saving destination.
	Prefix	Set the prefix character string of file name.
[Arbitrary] [Sequential number]	Folder	Set the data file name. The folder for saving the file is displayed in the Folder.
	File	

Setting	Selections available
CSV decimal point	Set the decimal point character of the CSV file. Period (.), Comma (,)
CSV delimiter	Set the delimiter of the CSV file. Comma (,), Tab, Semicolon (;)

### (2)-1 Sampling interval (main sampling interval)

Set the interval for capturing data.

Setting	Description
Internal RAM	1, 2, 5, 10, 20, 50, 100, 200, 500 $\mu$ s, 1, 2, 5, 10, 20, 50, 100, 200, 500ms, 1, 2, 5, 10, 20, 30s, 1min, External
Internal memory/SD card/USB memory	(1, 2, 5,) 10, 20, 50, 100, 200, 500ms, 1, 2, 5, 10, 20, 30s, 1min, External * When the CSV file format is set after Relay function is enabled, the sampling in parentheses () cannot be selected.

#### CAUTION

- When the internal RAM is selected and the external sampling is set, the data is read in 1  $\mu$ s as internal processing, an external pulse is used, and the next internal processing data is write to the memory. Therefore, the capturing interval is maximum 1  $\mu$ s and the maximum input error is 1  $\mu$ s.

Please use the external sampling function within the range where this error is not a problem.

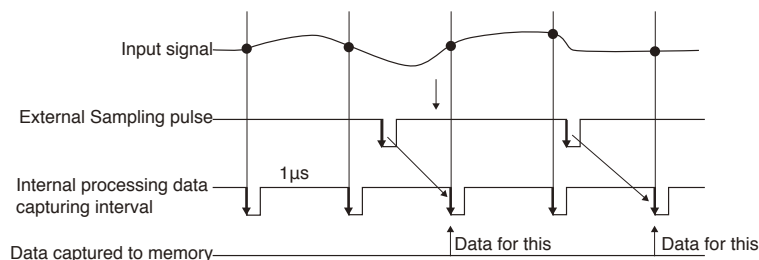

#### CHECKPOINT

- When the external sampling function is set to On and then internal memory/SD card/USB memory is selected, the internal processing interval is 1 ms. The capturing interval is also 1 ms maximum.
- If the external sampling function is ON, the external input cannot be selected for the trigger setting. If the external input has already been set, the trigger will be set to Off.

**(2)-2 Pulse sampling interval**

Set the interval for capturing pulse data.

The pulse sampling interval can be set under the following conditions.

Condition 1: Main sampling and interval are the same or larger.

Condition 2: Sampling interval which is n times main sampling.

When changing the main sampling interval, if it does not meet the above conditions, the sampling interval for pulse is also initialized in the same way as the main sampling interval.

Main Sampling Interval	Pulse sampling Interval																														
	$\mu s$										ms										s					min			hour		
	1	2	5	10	20	50	100	200	500	1	2	5	10	20	50	100	200	500	1	2	5	10	20	30	1	2	5	10	20	30	1
1	○	○	○	○	○	○	○	○	○	○	○	○	○	○	○	○	○	○	○	○	○	○	○	○	○	○	○	○	○	○	○
2	×	○	×	○	○	○	○	○	○	○	○	○	○	○	○	○	○	○	○	○	○	○	○	○	○	○	○	○	○	○	○
5	×	×	○	○	○	○	○	○	○	○	○	○	○	○	○	○	○	○	○	○	○	○	○	○	○	○	○	○	○	○	○
10	×	×	×	○	○	○	○	○	○	○	○	○	○	○	○	○	○	○	○	○	○	○	○	○	○	○	○	○	○	○	○
20	×	×	×	×	○	×	○	○	○	○	○	○	○	○	○	○	○	○	○	○	○	○	○	○	○	○	○	○	○	○	○
50	×	×	×	×	×	○	○	○	○	○	○	○	○	○	○	○	○	○	○	○	○	○	○	○	○	○	○	○	○	○	○
100	×	×	×	×	×	×	○	○	○	○	○	○	○	○	○	○	○	○	○	○	○	○	○	○	○	○	○	○	○	○	○
200	×	×	×	×	×	×	×	○	×	○	○	○	○	○	○	○	○	○	○	○	○	○	○	○	○	○	○	○	○	○	○
500	×	×	×	×	×	×	×	○	○	○	○	○	○	○	○	○	○	○	○	○	○	○	○	○	○	○	○	○	○	○	○
1	×	×	×	×	×	×	×	×	○	○	○	○	○	○	○	○	○	○	○	○	○	○	○	○	○	○	○	○	○	○	○
2	×	×	×	×	×	×	×	×	×	○	×	○	○	○	○	○	○	○	○	○	○	○	○	○	○	○	○	○	○	○	○
5	×	×	×	×	×	×	×	×	×	○	○	○	○	○	○	○	○	○	○	○	○	○	○	○	○	○	○	○	○	○	○
10	×	×	×	×	×	×	×	×	×	○	○	○	○	○	○	○	○	○	○	○	○	○	○	○	○	○	○	○	○	○	○
20	×	×	×	×	×	×	×	×	×	○	○	○	○	○	○	○	○	○	○	○	○	○	○	○	○	○	○	○	○	○	○
50	×	×	×	×	×	×	×	×	×	○	○	○	○	○	○	○	○	○	○	○	○	○	○	○	○	○	○	○	○	○	○
100	×	×	×	×	×	×	×	×	×	○	○	○	○	○	○	○	○	○	○	○	○	○	○	○	○	○	○	○	○	○	○
200	×	×	×	×	×	×	×	×	×	○	○	○	○	○	○	○	○	○	○	○	○	○	○	○	○	○	○	○	○	○	○
500	×	×	×	×	×	×	×	×	×	○	○	○	○	○	○	○	○	○	○	○	○	○	○	○	○	○	○	○	○	○	○
1	×	×	×	×	×	×	×	×	×	○	○	○	○	○	○	○	○	○	○	○	○	○	○	○	○	○	○	○	○	○	○
2	×	×	×	×	×	×	×	×	×	○	○	○	○	○	○	○	○	○	○	○	○	○	○	○	○	○	○	○	○	○	○
5	×	×	×	×	×	×	×	×	×	○	○	○	○	○	○	○	○	○	○	○	○	○	○	○	○	○	○	○	○	○	○
10	×	×	×	×	×	×	×	×	×	○	○	○	○	○	○	○	○	○	○	○	○	○	○	○	○	○	○	○	○	○	○
20	×	×	×	×	×	×	×	×	×	○	○	○	○	○	○	○	○	○	○	○	○	○	○	○	○	○	○	○	○	○	○
30	×	×	×	×	×	×	×	×	×	○	○	○	○	○	○	○	○	○	○	○	○	○	○	○	○	○	○	○	○	○	○
1 min	×	×	×	×	×	×	×	×	×	○	○	○	○	○	○	○	○	○	○	○	○	○	○	○	○	○	○	○	○	○	○

**(2)-3 Capturing destination**

Set the capturing destination of the measured data.

Setting	Description
Internal RAM	<p>The measured data is captured to the internal RAM. The data is lost when you turn off the power. When Overwrite is set to On, the data is overwritten if the next capturing is performed. Confirm the waveform, if it is OK, press the "File" key to save the data. (Refer to "3.5 Setting Menus" - "7. File menu".)</p> <p>Also, When Auto Save is set to On, the data is saved automatically.</p> <p><b>TIP</b></p> <p>You can use for all the sampling intervals. Select it if you want to capture at speed faster than 500 <math>\mu</math>s. Also, if you check the waveform of the captured data and save only the necessary data, the memory is saved.</p>
Internal memory/ SD card/ USB memory	<p>The measured data is captured to the internal memory/SD card/USB memory. The captured data is not lost even when the power is turned off. This cannot be selected when the sampling interval is 1 to 500 <math>\mu</math>s. In this case, set the sampling interval to a value slower than 1 ms.</p> <p><b>TIP</b></p> <p>You can also use large capacity SD card (*1)/USB memory (*2) (*3). It is convenient when the capacity of the internal memory is insufficient (up to 4GB can be saved in one capturing) such as the case you want to capture many times or you measure for a long time.</p> <p>(*1) SD card and SDHC card are available. SDXC memory card is not available.</p> <p>(*2) FAT format is available. NTFS format is not available.</p> <p>(*3) Please note that you cannot use the USB memory with security function such as fingerprint authentication and the USB memory without shell (metal part) in the connector part.</p> <p>For check the latest information and support information, please check with the following URL. <a href="http://www.graphtec.co.jp">http://www.graphtec.co.jp</a></p>

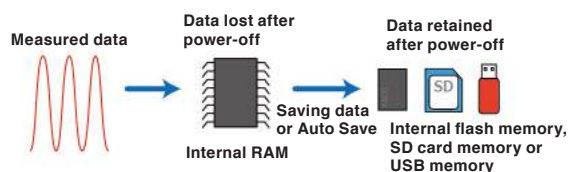



### (2)-4 Memory block division

Internal RAM can be divided into blocks. Multiple data can be captured to divided blocks.

This item can be set only when the capturing destination is set to internal RAM.

The number of divided blocks and the maximum number of data points when divided is as shown in the table below.

Number of divisions	Maximum capturing points
No division	400000 points
2-division	200000 points
4-division	100000 points
8-division	500000 points

#### **CHECKPOINT**

When changing the number of divided blocks in the internal RAM, all data saved in the internal RAM is erased.

### (2)-5 Overwrite mode

Set whether to overwrite the data in the internal RAM or not.

This item can be set only when the capturing destination is set to internal RAM.

If Overwrite is set to On, even if there is already captured data, the data is erased and overwritten.

Using a block usage situation, the difference of On and Off of the overwrite mode is described .

#### < Overwrite mode Off >

pattern 1

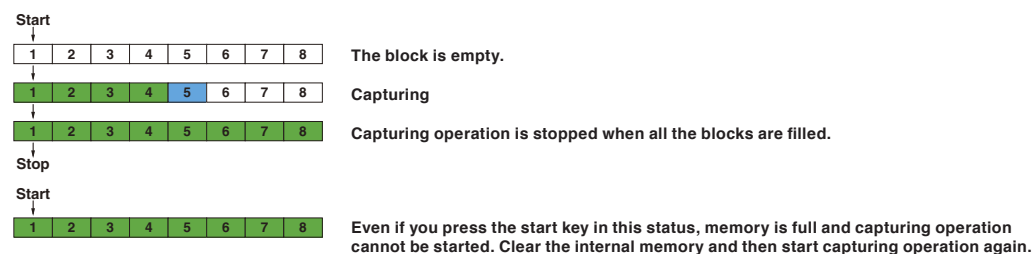

pattern 2

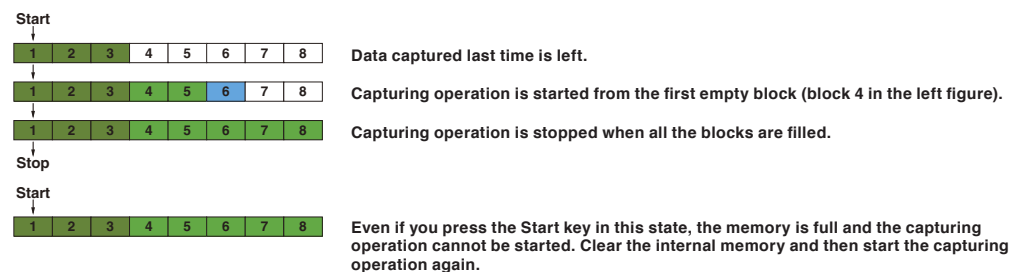

<Overwrite mode is On>

pattern 1

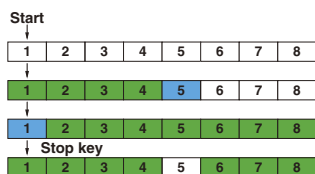

The block is empty.  
 Capturing  
 Even if all the blocks are filled, this device continues capturing from Block 1.  
 The data is not captured to the block captured last time unless the trigger is established. If you stop the capturing in the middle after the trigger has been established, the block becomes a block which does not contain all the data.

pattern 2

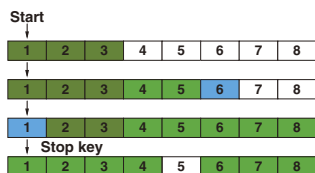

Data captured last time is left.  
 Capturing operation is started from the next block that was captured last time (Block 4 in the left figure).  
 Even if all the blocks are filled, this device continues capturing from Block 1.  
 The data is not captured to the block captured last time unless the trigger is established. If you stop the capturing in the middle after the trigger has been established, the block becomes a block which does not contain all the data.

pattern 3

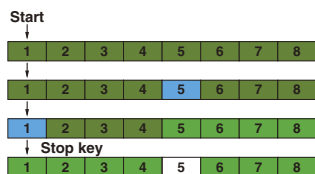

Data captured last time is left. (Last time, it stopped at block 4.)  
 Capturing operation is started from the next block that was captured last time (Block 5 in the left figure).  
 Even if all the blocks are filled, this device continues capturing from Block 1.  
 The data is not captured to the block captured last time unless the trigger is established. If you stop the capturing in the middle after the trigger has been established, the block becomes a block which does not contain all the data.



A yellow line is displayed above the block number at which next capture starts.



**(2)-6 Internal RAM clear**

Erase data saved in internal RAM.  
 This item can be set only when the capturing destination is set to internal RAM.  
 Please be aware that erased data cannot be restored.  
 Save the necessary data in the internal memory/SD card/USB memory before erasing.

**(2)-7 Capturing points**

Set the number of data points to be captured to the internal RAM. This item can be set only when the capturing destination is set to internal RAM.

To set it, refer to the capturable time display.



The maximum settable number of capturing points depends on the number of blocks divided in the internal RAM.

Setting	Description
No division	400000 points
2-division	200000 points
4-division	100000 points
8-division	500000 points

**(2)-8 Ring capturing (internal RAM)**

Set ring capture for internal RAM.

This item can be set only when the capturing destination is set to internal RAM.

Ring capture is a function to continue data capture even if the data points exceed the number of data points set by setting the number of captured points using the internal RAM as a ring buffer. If more than the number of captured points set in the number of set data points is captured, the oldest data is erased in order and the latest data for the number of set data points remains.

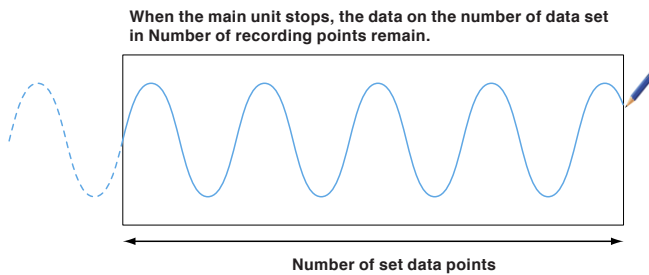

**(2)-9 Auto save**

Set whether to automatically save the data captured to the internal RAM. This item can be set only when the internal RAM is selected as the capturing destination.

Setting	Description
Off	Auto save is not performed. Data captured to the internal RAM is lost if you turn off the power or start the next capturing. To save the captured data, you need to save it by pressing "File" key.
On	Auto save is performed. Data captured to the internal RAM is saved in the internal memory/SD card/USB memory.   <p>If you set the faster sampling interval or increase the number of data points, the Auto Save may not be completed even if the capturing to the internal RAM is completed. In that case, you cannot perform the next capturing with the Start/Stop key until the Auto Save is completed. If you want to stop automatic save in the middle, select the "Auto Save stop" with the dialog button if the dialog is displayed, select "Auto Save stop" from the file menu or the function key otherwise. If you execute Auto Save stop, the data up to that point is saved.</p>



Dialog display

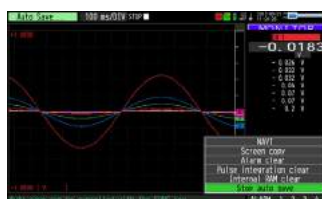

Function key

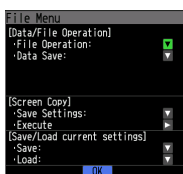

File menu

**(2)-10 Capturing destination file name (auto save)**

Set the saving destination/file name when executing auto save.

This item can be set only when the capturing destination is set to internal RAM and auto save is set to On.  
For details of the contents, refer to (2) -11.

**(2)-11 Capturing destination file name (file capture)**

Set the file name and folder name of the capturing destination when capturing the data.

< When the automatic naming method is used >

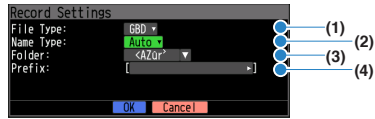

< When any file name and serial number is used for naming method >



< When CSV file is used as file format >



Setting	Description
(1) File Type	Set the file format of data. GBD: The data file is created in our own binary format. * Data cannot be changed. CSV: The data file is created in text format.
(2) Name Type	Set the naming method for the data file. Auto: File name is created automatically Example) 20170728-123456.GBD Numbers: Date and time when the file is created * The above example shows July 28, 2017 12:34:56 Arbitrary: Captured data is saved to the file with the file name you entered. Serial number: Captured data is saved to the file with the file name you entered and the serial number. Example) When the file name is set to "TEST" 1st time: TEST_SER1.GBD 2nd time: TEST_SER2.GBD 3rd time: TEST_SER3.GBD  * If the same file name already exists, "_CP*" is added to the end of the file name to avoid overwriting. The part of * is a number. Example) TEST_CP1.GBD
(3) Folder	Set the folder of saving destination when Auto is selected as the naming method.
(4) Prefix	Set the prefix character string of the file name. When a prefix character string is set, the prefix character string set before the automatically created file name (date/time/time file name) is added. Example) When "PRIFIX" is set as prefix character, The file name is "PRIFIX_20170728-123456.GBD".
(5) File	Set the saving file name when Arbitrary and Serial number is selected in naming method. The folder for saving the file is displayed in the Folder.
(6) CSV decimal point	Set the decimal point character of the CSV file. Period (.), Comma (,)
(7) CSV delimiter	Set the delimiter of the CSV file. Comma (,), Tab, Semicolon (;)

**CAUTION**

The file should be saved in the folder you created. When the data files are continued to be saved in the root folder, the data file may be not saved regardless of the memory remaining capacity due to the limitations of the file system.

**CHECKPOINT**

Changing the sampling interval, capture destination, number of measuring channels (number of channels for which the input is not Off), etc. will change the Capture Space and Capture Time on the screen.

If you find that the measurement time exceeds the Capture Time, take one of the following measures:

- Change the sampling interval.
- Change the capturing destination SD card / USB memory to SD card / USB memory with more free space.

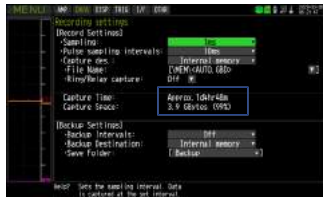

**Capture Space :** Displays the amount of memory space available for data capture.

**Capture Time :** Displays the time that can be captured

The Capture Time more than 366 days is displayed as 366 day over

---

**(2)-12 Ring/Relay capture settings**

• Ring Capture Function

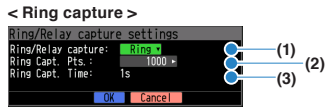

Setting	Description
(1) Ring/Relay capture	Set the capturing function. off: Capturing function is not used. Ring: Ring capture is performed. (For details, refer to the figure below.) Relay: Data is captured consecutively for each file of up to 4GB without missing data. When the relay function is enabled, the sampling interval is from 10 ms when the CSV file format is set.
(2) Ring Capt. Pts.	When the ring capturing function is used, specify the number of data points of one file. (For details, refer to the figure below.)
(3) Ring Capt. Time	When the ring capturing function is On, the measurement time that can be captured with one file is displayed.

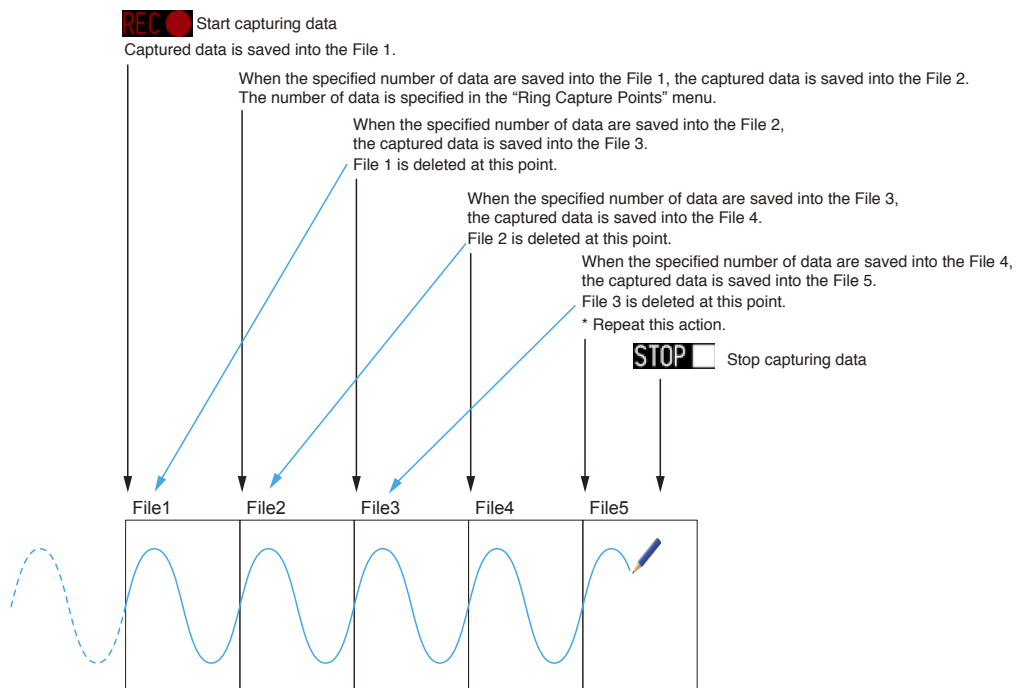

When capturing is stopped at the STOP point in the above, the File4 and the File 5 are remained.  
These files are consolidated into one file and it is saved. Then the ring capuer is completed.

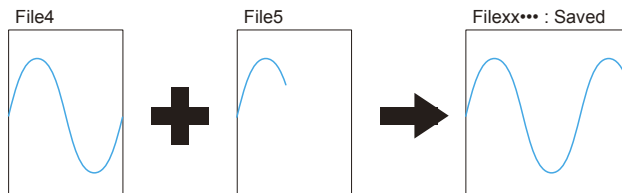

**CHECKPOINT**

Twice as many files as the Number of Ring Capture Points will be created at the maximum.

• Relay Capture Function

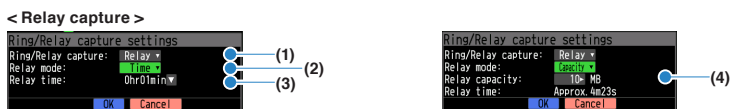

Setting	Description
(1) Ring/Relay capture	Set the capturing function. off: Capturing function is not used. Ring: Ring capture is performed. (For details, refer to the figure below.) Relay: Data is captured consecutively for each file of up to 4GB without missing data. When the relay function is enabled, the sampling interval is from 10 ms when the CSV file format is set.
(2) Relay mode	Set the mode for performing the relay processing. Time: After the set time has elapsed, the relay processing is performed. Capacity: When the file has reached the set file size, the relay processing is performed.
(3) Relay time	Set the relay time when relay mode is set to "Time". 0 hour 1 minute to 24 hours 00 minutes * If the file size reaches 4GB before the set time elapses, the relay processing is performed even before the elapse of time.
(4) Relay capacity	Set the file size when relay mode is set to "Capacity". 10MB to 4000MB * Estimated time for capturing with the set file size is displayed as "Relay time".

The captured data is continuously captured by files separated in the set relay unit without losing data.  
(The maximum capacity of one file is 4GB.)



**(2)-13 Backup setting**

This device has a function to periodically back up captured data.  
(Refer to the figure below.)

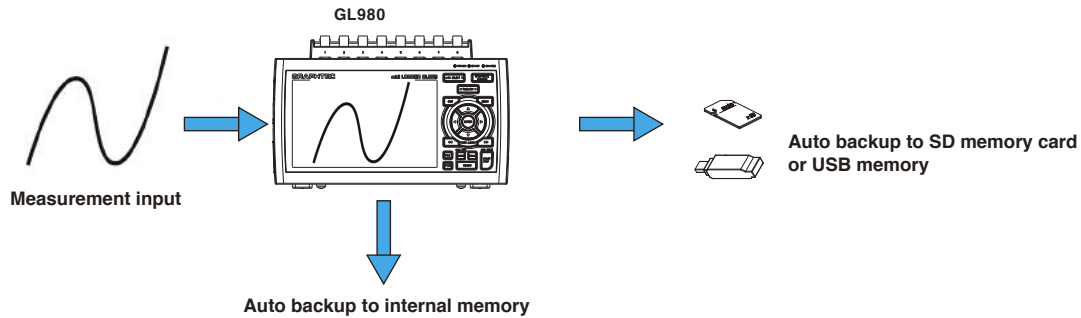

Setting	Description
(1) Backup intervals	Set the interval to back up the captured data. Off, 1, 2, 6, 12, 24 hours
(2) Backup Destination	Set the backup destination of the captured data.
	Internal memory   The data is backed up to the internal memory of this device.
	SD card   The data is backed up to the SD card.
	USB memory   The data is backed up to the USB memory. * Capturing destination and backup destination cannot be the same. * When SD card or USB memory is selected as backup destination, SD card and USB memory can be replaced. For details, refer to "3.5 Setting Menu" - "7. File menu".
(3) Save folder	Set the folder to save the backup file. * It becomes the folder of the drive specified as the save destination. Example) \GRAPHTEC\20150201

**CHECKPOINT**

If ring capture is On, the backup function is not available.

When set to the CSV file format, the sampling interval is from 10 ms.

### (3) DISP settings

Set the screen display settings.

#### (3)-1 Y-T/Y-T (full screen) display

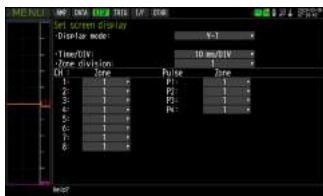

Setting	Description
Display mode	Set the display mode of the screen. Y-T, Y-T (full screen), Logging, XY
Time/DIV	Set the Time/DIV. The settable range depends on the sampling interval.
Zone division	Set the number of zone divisions. 1, 2, 4, 8
Zone	Set the zone allocation for analog CH and pulse CH. 1 to 8
Logic zone	Set the display position of the logic CH. 1 to 10

#### Display mode

Select the screen display mode.

Setting	Description
Y-T	Set to Y-T waveform + Monitor display.
Y-T (full screen)	Set to All the waveforms of Y- T.
Logging	Set to Logging display/Real time statistical calculation display.
XY	Set to XY waveform display.

The contents in the DISP menu depend on each display mode.

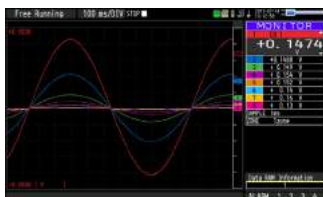

Y-T waveform + monitor display

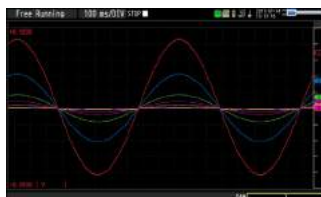

Y-T full waveform display



Logging display



Real time statistical calculation display



XY waveform display

### Time/DIV

This is a function to enlarge or shrink the horizontal axis (T) of the waveform of Y-T graph. When setting it, set the time for one grid of graph. The shorter the setting time, the larger the horizontal axis (T).

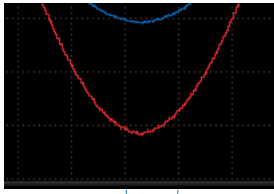

Set the time for one grid of graph

The range of the Time/DIV value that you can set depends on the sampling interval setting.

Please refer to the table below.

Sampling Interval	Time/DIV																										
	us						ms						s						min								
	10	20	50	100	200	500	1	2	5	10	20	50	100	200	500	1	2	5	10	20	30	1	2	5	10	20	30
1us	●	●	●	●	●	●	●	●	●	○	○	○	○	○	○	○	○	○	○	○	○	○	○	○	○	○	○
2us	×	●	●	●	●	●	●	●	●	○	○	○	○	○	○	×	×	×	×	×	×	×	×	×	×	×	×
5us	×	×	●	●	●	●	●	●	●	○	○	○	○	○	○	×	×	×	×	×	×	×	×	×	×	×	×
10us	×	×	×	●	●	●	●	●	●	○	○	○	○	○	○	×	×	×	×	×	×	×	×	×	×	×	×
20us	×	×	×	×	●	●	●	●	●	○	○	○	○	○	○	○	○	○	×	×	×	×	×	×	×	×	×
50us	×	×	×	×	×	●	●	●	●	○	○	○	○	○	○	○	○	○	×	×	×	×	×	×	×	×	×
100us	×	×	×	×	×	×	●	●	●	○	○	○	○	○	○	○	○	○	○	×	×	×	×	×	×	×	×
200us	×	×	×	×	×	×	×	●	●	○	○	○	○	○	○	○	○	○	○	○	○	×	×	×	×	×	×
500us	×	×	×	×	×	×	×	×	○	○	○	○	○	○	○	○	○	○	○	○	○	○	○	○	○	○	○

X: Not available ●: Available when replaying only ○: Available when replaying and real time

Sampling Interval	Time/DIV																										
	ms						s						min						hour								
	1	2	5	10	20	50	100	200	500	1	2	5	10	20	30	1	2	5	10	20	30	1	2	5	10	12	24
1ms	×	×	×	○	○	○	○	○	○	○	○	○	○	○	○	○	○	×	×	×	×	×	×	×	×	×	×
2ms	×	×	×	×	○	○	○	○	○	○	○	○	○	○	○	○	○	○	×	×	×	×	×	×	×	×	×
5ms	×	×	×	×	○	○	○	○	○	○	○	○	○	○	○	○	○	○	×	×	×	×	×	×	×	×	×
10ms	×	×	×	×	×	○	○	○	○	○	○	○	○	○	○	○	○	○	○	×	×	×	×	×	×	×	×
20ms	×	×	×	×	×	×	×	×	×	○	○	○	○	○	○	○	○	○	○	○	○	×	×	×	×	×	×
50ms	×	×	×	×	×	×	×	×	×	○	○	○	○	○	○	○	○	○	○	○	○	○	×	×	×	×	×
100ms	×	×	×	×	×	×	×	×	×	○	○	○	○	○	○	○	○	○	○	○	○	○	○	×	×	×	×
200ms	×	×	×	×	×	×	×	×	×	○	○	○	○	○	○	○	○	○	○	○	○	○	○	○	○	○	○
500ms	×	×	×	×	×	×	×	×	×	○	○	○	○	○	○	○	○	○	○	○	○	○	○	○	○	○	○
1s	×	×	×	×	×	×	×	×	×	×	×	○	○	○	○	○	○	○	○	○	○	○	○	○	○	○	○
2s	×	×	×	×	×	×	×	×	×	×	×	×	○	○	○	○	○	○	○	○	○	○	○	○	○	○	○
5s	×	×	×	×	×	×	×	×	×	×	×	×	×	×	×	○	○	○	○	○	○	○	○	○	○	○	○
10s	×	×	×	×	×	×	×	×	×	×	×	×	×	×	×	×	○	○	○	○	○	○	○	○	○	○	○
20s	×	×	×	×	×	×	×	×	×	×	×	×	×	×	×	×	×	○	○	○	○	○	○	○	○	○	○
30s	×	×	×	×	×	×	×	×	×	×	×	×	×	×	×	×	×	×	○	○	○	○	○	○	○	○	○
1min	×	×	×	×	×	×	×	×	×	×	×	×	×	×	×	×	×	×	×	○	○	○	○	○	○	○	○

X: Not available ●: Available when replaying only ○: Available when replaying and real time

## Zone division

This is a function to divide the Y-axis of the Y-T graph waveform into multiple zones and displays the graphs so that they do not overlap. You can select from 1-zone (no zone division), 2-zone division, 4-zone division or 8-zone division.

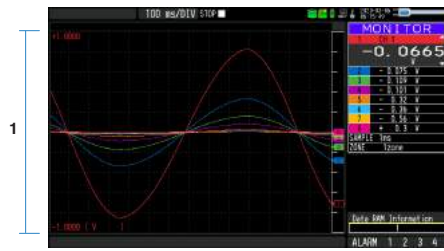

1-zone (no zone division)

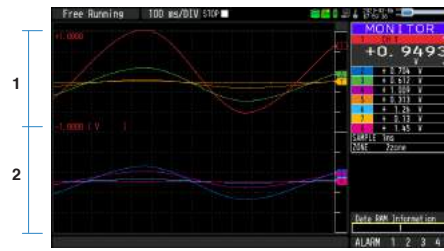

2-zone division

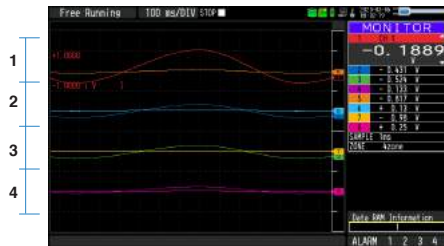

4-zone division

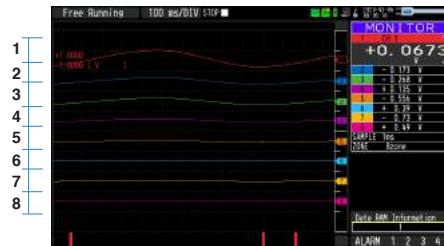

8-zone division

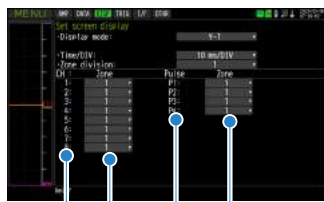

Analog CH      Pulse CH  
 Analog CH      Pulse CH  
 Zone allocation setting      Zone allocation setting

Analog CH and pulse CH can be freely assigned to each zone.

## Logic zone

Logic zone is unique 10-zone, which is different from analog CH and pulse CH. Logic CH1 to Logic CH4 are displayed together in one logic zone.



10-zone division

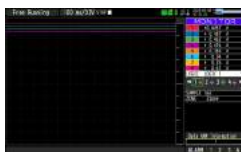

Zone 1

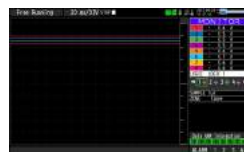

Zone 2

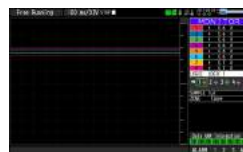

Zone 3

.....

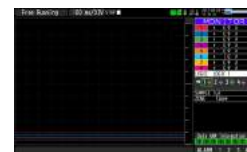

Zone 10

.....



Logic zone setting

**(3)-2 Logging display**



Setting	Description
Display mode	Set the display mode of screen. Y-T, Y-T (full screen), Logging, XY
Display format	Set the display format of the logging screen. 2-division, 4-division, 8-division, Statistical operation * To select the real time statistics calculation screen, select the statistical operation.
Display contents	Select the display contents of the logging screen. Analog CH number can be selected. When Logic or Pulse is selected, Logic/Pulse CH number can be selected.
Statistical operation clear	Clear (initialize) real time statistical operation.

**Display format**

Set the display format of the logging screen.

When statistical calculation is selected, real time statistical calculation screen is displayed.

If selecting other than it, the logging screen is displayed.

< Logging screen >



< Real time statistical calculation screen >

CH	VALUE	Max	Min	P-P	Ave
CH1	+0.0009	-0.0009	+0.0007	+0.0002	+0.0008
CH2	+0.0019	-0.0025	+0.0008	+0.0017	+0.0017
CH3	-0.016	-0.015	-0.019	+0.004	-0.017
CH4	-0.012	-0.008	-0.017	+0.009	-0.012
CH5	-0.095	-0.085	-0.106	+0.021	-0.095
CH6	-0.13	-0.11	-0.15	+0.04	-0.13
CH7	-0.23	-0.19	-0.27	+0.08	-0.23
CH8	-0.17	+0.36	+0.65	+0.29	+0.19
STAT	100.0	100.0	100.0	100.0	100.0
TIME	21	31	41		

### Display contents

Select the content displayed on each display frame on the logging screen.

You can select from analog CH (CH1 to CH8/Pulse CH (P1 to P4)/Logic.

Same as this selected part.



The zone allocation when divided is as shown in the figure below.



2-division

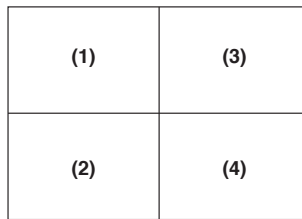

4-division

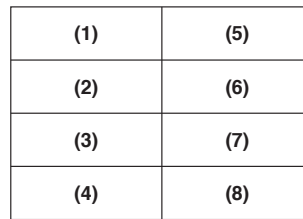

8-division

### Statistical calculation clear

Clear (initialize) real time statistical calculation.

The maximum value, the minimum value and the P-P value are initialized to 0 respectively.

The average value is set to the initial value 0, and after capturing the data more than 1 point, the average value is displayed.

### (3)-3 XY display



Setting		Description
Display mode		Set the display mode of the screen. Y-T, Y-T (full screen), Logging, XY
CH		Set the X- axis and Y- axis of XY graph. CH1 to CH8
Trace		Set the trace of XY graph. Off, On Waveforms are not displayed on the screen when trace is Off. Also they are not displayed on the monitor display.
Position		Set the XY position. 0% to 100%
Vernier		Set the XY vernier. 40 to 100% * The range depends on the range setting.
Span	Upper limit	Set the span. You can set it when the analog CH in the Span mode is set on the axis.
	Lower limit	
Zero point		Automatic zero adjustment of the analog CH set to the X-axis and Y-axis is performed.
Origin		Set the origin position in the Y graph. Center, Lower left
Execute		Initialize the XY position to the set origin.
Clear waveform at the start of recording.		Set the enable or disable of XY waveform clearing at the start of capturing. Off, On
XY display clear		Perform the XY waveform clear manually.
XY Overwrite	Select File	Select the image file to be overwritten and then perform the overwriting.
	Overwrite clear	The XY overwrite is cleared and completed.

#### CH (X-axis/Y-axis CH setting)

Set X-axis and Y-axis of XY graph.

You can select from among analog CHs.

#### Trace

Set the trace of XY waveform.

XY-CH which trace is set to Off is not displayed on the graph and the monitor display.



### Position (XY position)

Set the XY position.

This setting is used for XY display only.

It is different from the position setting for Y-T waveform display (The position setting that can be operated on the monitor at Y-T waveform + Monitor display.).

For XY position setting, set the drawing reference position to 0% for the lower left and 100% for the upper right of the XY graph.

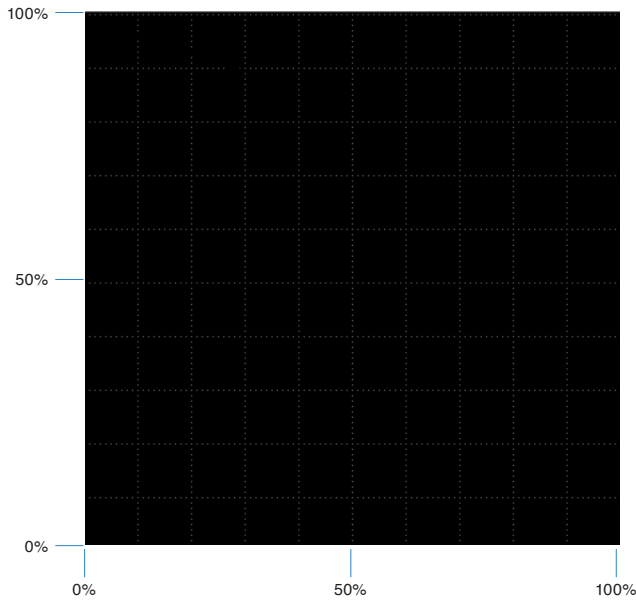

The measurement range displayed on the graph by the XY position setting is as follows.

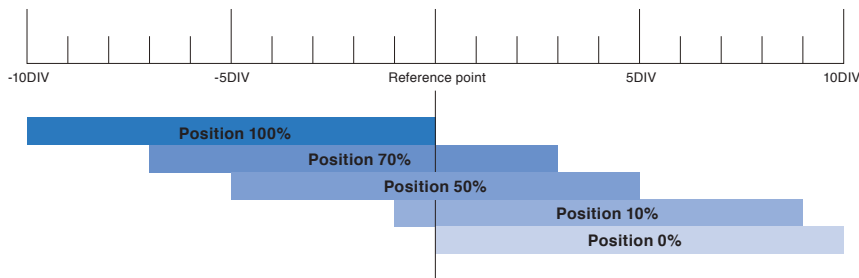

As shown in the figure above, the display range moves parallel 10DIV area by XY position setting.

XY position setting is set only for XY graph.

Position reference point differs between range mode and span mode.

- Range mode

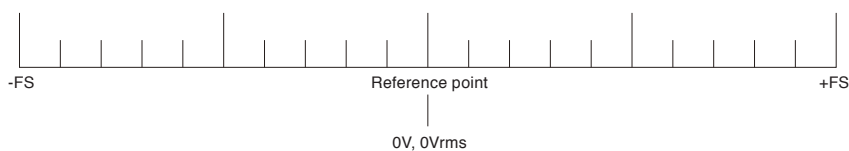

The position reference point in Range mode is 0V or 0Vrms.

• Span mode

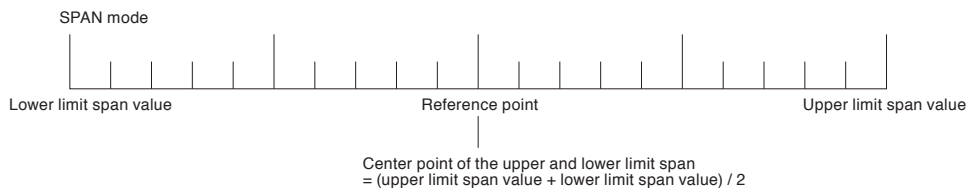

The position reference point in Span mode is the center point between the upper limit span value and the lower limit span value.

Also, the lower limit span value is placed at -5DIV position and the upper limit span value is placed at 5DIV position.

For details of Range mode/Span mode, refer to "3.3 Operation Modes"-"(3) XY waveform display" - "Range mode/Span mode".

**Vernier**

The Vernier is a function to adjust the amplitude (gain).

Adjust the display width range of the waveform displayed on the XY graph.

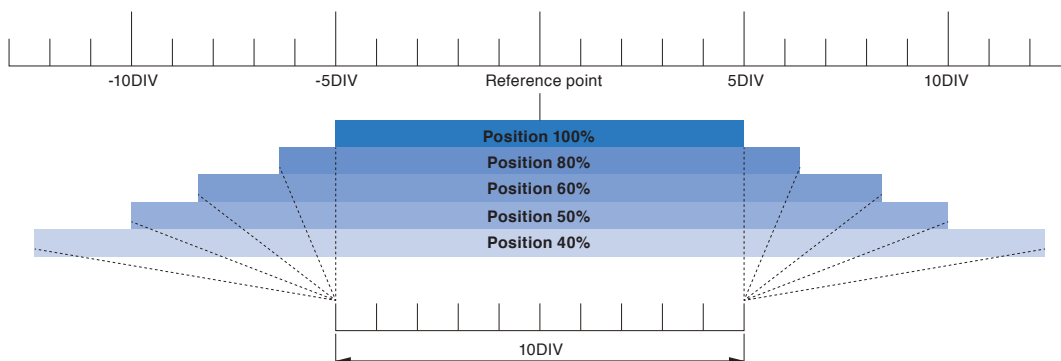

When the Vernier is set to 100%, it becomes equal magnification. Therefore the waveform display is shrunk by the Vernier setting magnification.

For example, when the Vernier is set to 80%, it is displayed with a size of 80% compared with 100%.

(The above figure shows the sample when the XY position is set to 50%)

The setting range for the Vernier setting of the Range mode depends on the set range.

V/DIV range	Vernier setting range
1mV/DIV	100% to 50%
2mV/DIV	100% to 40%
5mV/DIV	100% to 50%
10mV/DIV	100% to 50%
20mV/DIV	100% to 40%
50mV/DIV	100% to 50%
100mV/DIV	100% to 50%
200mV/DIV	100% to 40%
500mV/DIV	100% to 50%
1V/DIV	100% to 50%
2V/DIV	100% to 40%
5V/DIV	100% to 50%
10V/DIV	100% to 50%
20V/DIV	100% to 40%

V/DIV range	Vernier setting range
0.5mVrms/DIV	100% to 50%
1mVrms/DIV	100% to 40%
2.5mVrms/DIV	100% to 50%
5mVrms/DIV	100% to 50%
10mVrms/DIV	100% to 40%
25mVrms/DIV	100% to 50%
50mVrms/DIV	100% to 50%
100mVrms/DIV	100% to 40%
250mVrms/DIV	100% to 50%
500mVrms/DIV	100% to 50%
1Vrms/DIV	100% to 40%
2.5Vrms/DIV	100% to 50%
5Vrms/DIV	100% to 50%
10Vrms/DIV	100% to 40%

The

Vernier setting of the Span mode can be set within the range of 40 to 100%.

Also, the span lower limit is set to the -5DIV position and the span upper limit is set to the 5DIV position.

## Span

The span can be selected when Span mode CH is set on X-axis and Y-axis.

It is common setting with Span set in Y-T waveform display (AMP menu).

Changing the Span setting affects the position reference point and the basic range of the vernier (the range displayed in the graph when the vernier is set to 100%)

For details of Range mode/Span mode, refer to "3.3 Operation Modes"-"(3) XY waveform display"-" Range mode/Span mode".

## Zero point

Automatic zero adjustment is performed.

Automatic zero adjustment for 2CH of the analog CH set on the X-axis and Y-axis is performed.

When the analog CH input is set to temperature, automatic zero adjustment is not performed.

For details of automatic zero point adjustment, refer to "3.5 Setting Menues" - "(1) AMP settings" - "Zero adjustmentfunction"

## Origin

Set the origin of the X-Y graph.

The center and lower left can be selected.

When "Execute" is selected, the XY position is initialized to the position selected as the origin.

- Initialization position

Center: X-axis position 50%, Y-axis position 50%

Lower left : X-axis position 0%, Y-axis position 0%



Center: Origin



Origin: Lower left

## Waveform clear at the start of capturing

Set whether to erase the XY waveform display (pen trajectory) at the start of capturing.

When set to On, the XY waveform display is erased at the start of capturing.

## XY display clear

Manually erase the XY waveform display (pen trajectory).

The erased waveforms cannot be restored, therefore save the screen copy from the FILE menu if necessary.

For details of XY display clear, refer to "3.5 Setting Menues" - "(7) FILE menu" - "Screen copy".

## XY Overwrite



Setting	Description
(1) Select File	Select the image file to be overwritten and then perform the XY overwriting. The image file is a screen copy of the file menu in XY display, and the storage range is the image file saved as the waveform screen.
(2) Overwrite clear	The XY overwrite image is erased and the XY overwriting is completed.

You can display the image file saved the saving range as a "Waveform screen" as the background image of the XY graph at XY waveform display.

(Other than the waveform screen image file saved by this device are not available.)

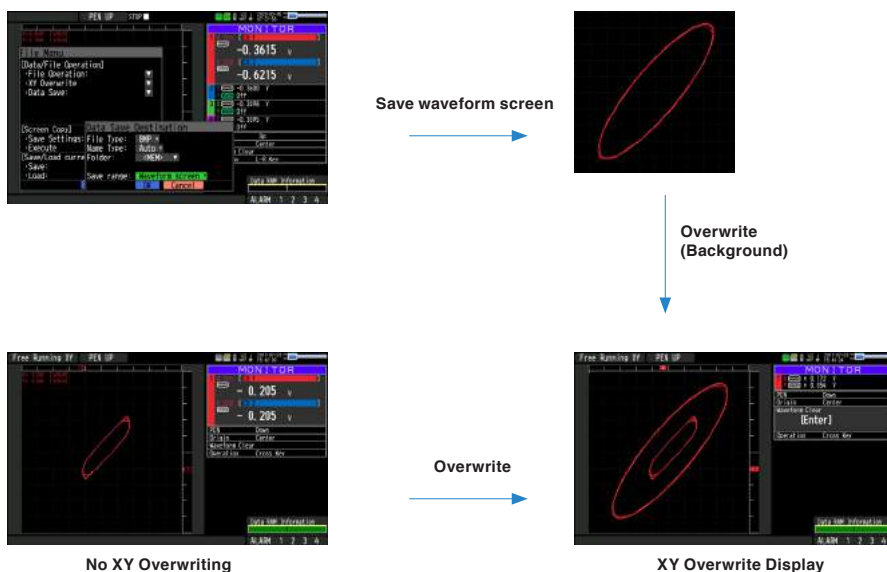

The background image to be overwritten is not erased even if operating the XY display clear.

Perform "Overwrite clear" separately.

\* It is overwritten even during replaying.

### CAUTION

The Overwrite is a function to read the image as image data to the background. For the waveform displayed in the background, even if you change the XY position and VERNIER setting, etc., it will not be reflected.

## (4) TRIG settings

Set the trigger condition and the alarm.



Setting	Selections available
Start Source	Set the type of start trigger. Off, Level, Alarm, External input, Specified time, Specified day of the week, Constant time
[Off]	Set to Off when not using trigger.
[Level value]	Combination Set the trigger signal detecting method and combination for each CH. Level OR, Level AND, Edge OR, Edge AND
	Mode Set the level of trigger mode. Analog: Off, H (Rising), L (Falling), Window In, Window Out Logic: Off, H, L Pulse: Off, H (Rising), L (Falling), Window In, Window Out * The value in the parentheses is displayed when the Combination is set to Edge.
	Level Set the trigger level value. Set by numerical value.
[Alarm]	Alarm port number Set the alarm output port number that generates the trigger. 1, 2, 3, 4
[External input]	Set it when inputting the trigger signal from the outside.
[Specified time] Specified time setting	Repeat unit Set the unit for repeating the trigger time. Absolute time, Year, Month, Day, Hour, Minute
	Date Set the trigger date. Jan. 1, 2000 – Dec. 31, 2035 * Settable item varies depending on repeat unit setting.
	Time Set the trigger time. 0 hour 0 minute 0 second to 23 hour 59 minute 59 second * Settable item varies depending on repeat unit setting.
[Specified day of the week] Specified day of the week setting	Day of the week Set the day of the week when the trigger is generated. Set to On or Off for Sunday to Saturday individually.
	Time Set the trigger time. 0 hour 0 minute 0 second to 23 hour 59 minute 59 second
[Constant time] Certain period of time setting	Set the time length of the trigger. 0 hour 0 minute 1 second to 9999 hour 59 minute 59 second
Stop Source	Off, Level value, Alarm, External input, Specified time, Specified day of the week, Constant time
[Off]	Set Off when not using trigger.
[Level value]	Combination Analog: Off, ↑ H, ↓ L, Window In, Window Out Logic: Off, ↑ Rising, ↓ Falling Pulse: Off, ↑ Rising, ↓ Falling, Window In, Window Out
	Mode Level OR, Level AND, Edge OR, Edge AND
	Level Set by numerical value.
[Alarm]	Alarm port number 1, 2, 3, 4
[External input]	Set it when inputting the trigger signal from the outside.
[Specified time] Specified time setting	Repeat unit Set the unit for repeating the trigger time. Absolute time, Year, Month, Day, Hour, Minute
	Date Set the trigger date. Jan. 1, 2000 – Dec. 31, 2035 * Settable item varies depending on repeat unit setting.
	Time Set the trigger time. 0 hour 0 minute 0 second to 23 hour 59 minute 59 second * Settable item varies depending on repeat unit setting.
[Specified day of the week] Specified day of the week setting	Day of the week Set the day of the week when the trigger is generated. Set to On or Off for Sunday to Saturday individually.
	Time Set the trigger time. 0 hour 0 minute 0 second to 23 hour 59 minute 59 second
[Constant time] Certain period of time setting	Set the time length of the trigger. 0 hour 0 minute 1 second to 9999 hour 59 minute 59 second

Setting		Selections available
Pre-trigger mode		Set the pre-trigger operation mode. Prioritize trigger, Prioritize pre-trigger capture * You can set the mode only when the capturing destination is internal RAM.
Pre-trigger data points		Set the number of data points for pre-trigger capture. 0 to Number of capturing points of internal RAM data * You can set the capturing points only when the capturing destination is internal RAM.
Repeat		Set the repeat capturing. Off, On
Repeat interval mode		Set the repeat interval mode. Start - Start, Stop - Start
Repeat int.		Set the repeat interval. 0 hour 0 minute 0 second to 9999 hour 59 minute 59 second
Alarm Settings	Mode	Set the alarm level mode. Analog: Off, H, L, Window In, Window Out Logic: Off, H, L Pulse: Off, H, L, Window In, Window Out
	Level	Set the alarm level value. Set by numerical value.
	Output	Set the alarm output CH when an alarm occurs. 1 to 4
Alarm Hold		Set whether to hold the alarm occurrence status. On, Off
Output 1		Set the output contents of the alarm output terminal 1. Alarm output 1, Trigger output

#### (4)-1 Start side source setting

This is used to specify trigger conditions to start data capture.

Selection item	Description
Off	Starts capturing data unconditionally when you press the [Start/Stop] key.
Level	Starts capturing data when a specified level is reached. -> When Level is selected, the condition for each channel must be set. Refer to "Trigger Level Settings/Alarm Level Settings" described below.
Alarm	Starts capturing data when an alarm is generated in the specified alarm port.
External Input	Starts capturing data when an input signal is received from an external trigger terminal. * A trigger is established at a transition from 5 V (open) to 0 V (shorted to the ground). A falling edge operation occurs.
Date	Refer to "Specified time setting" described below.
Weekly	Starts capturing data at the specified time on days of week for which On is set. Example: On is set for Mon, Tue, Wed, Thu, and Fri, Off is set for Sun and Sat, and 9:00 is set as the time. Starts capturing data at 9:00 on weekdays. Does not start capturing data on Sat and Sun.
Duration	Starts capturing data when a specified length of time elapses.

### (4)-2 Stop side source setting

This is used to specify trigger conditions to stop data capture.

Selection item	Description
Off	Stops capturing data unconditionally when you press the [Start/Stop] key.
Level	Stops capturing data when a specified level is reached. -> When Level is selected, the condition for each channel must be set. Refer to "Trigger Level Settings/Alarm Level Settings" described below.
Alarm	Stops capturing data when an alarm is generated in the specified alarm port.
External Input	Stops capturing data when an input signal is received from an external trigger terminal. * A trigger is established at a transition from 5 V (open) to 0 V (shorted to the ground). A falling edge operation occurs.
Date	Refer to "Specified time setting" described below.
Weekly	Stops capturing data at the specified time on days of week for which On is set. Example: On is set for Mon, Tue, Wed, Thu, and Fri, Off is set for Sun and Sat, and 9:00 is set as the time. Starts capturing data at 9:00 on weekdays. Does not stop capturing data on Sat and Sun..
Duration	Stops capturing data when a specified length of time elapses.

### **CHECKPOINT**

When External Input is used as the trigger source, no stop trigger is accepted for 50 ms after capture is started.

### (4)-3 Pre-trigger

For pre-trigger, set the number of data points to capture before trigger occurs.

\* Pre-trigger can be selected only when the capturing destination is set to the internal RAM.

The data before the trigger point is called "pre-trigger data", and the data after the trigger point is called "post-trigger data".

Perform the ring capture for pre-trigger data before the trigger occurs.

When the trigger is established, the capturing of the pre-trigger data is completed, the remaining post-trigger data is captured and then completed.

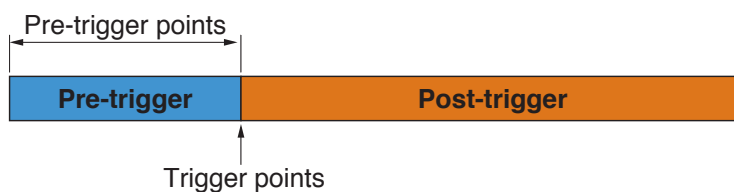

### **Pre-trigger mode**

Setting	Description
Prioritize trigger	When a trigger occurs during pre-trigger capture, the pre-trigger capture is completed.
Prioritize pre-trigger capture	Trigger is not accepted until pre-trigger capture is completed. Even if a trigger occurs, it is ignored.

< Prioritize trigger >

When a trigger occurs during pre-trigger capturing, even if capturing for the pre-trigger points has not been completed, pre-trigger capture is completed at the time of trigger and post-trigger data is captured immediately.

This is the case when a trigger occurs before the capturing for the pre-trigger points is completed.

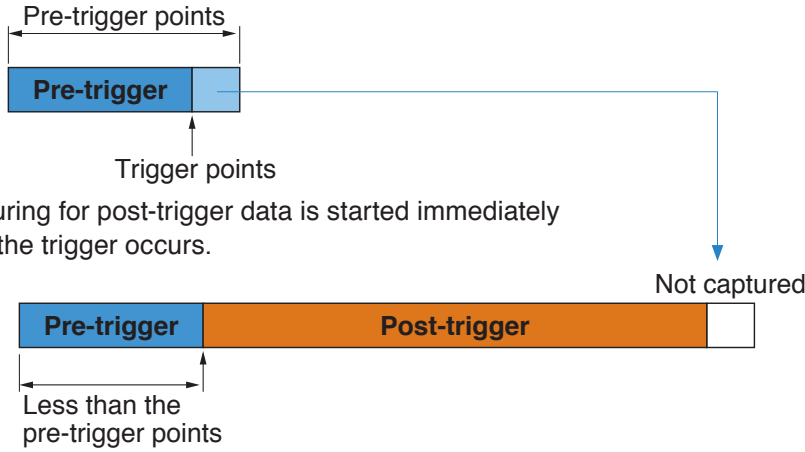

Capturing for post-trigger data is started immediately after the trigger occurs.

The data after capturing is less pre-trigger data points which than the specified pre-trigger point number. The pre-trigger data which could not be captured is uncaptured as it is and the total number of data points is reduced.

\* When a trigger occurs after completing the data corresponding to the pretrigger data points, there is no uncaptured data.

< Prioritize pre-trigger capturing >

When a trigger occurs during pre-trigger capturing, the trigger is ignored.

The trigger that occurs after the data capture corresponding to the pretrigger data points is completed is effective.

This is the case when a trigger occurs before the data capture corresponding to the pretrigger data points is completed.

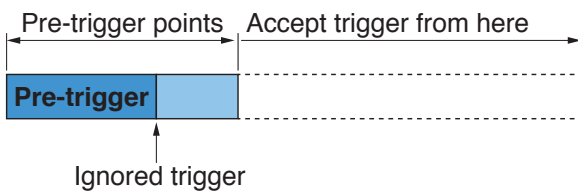

When a trigger occurs before the data capture corresponding to the pretrigger data points is completed, the trigger is ignored.

Trigger is accepted after the data capture corresponding to the pretrigger data points is completed.

After the trigger is accepted, as soon as the trigger occurs, the capturing of the post trigger data is started.

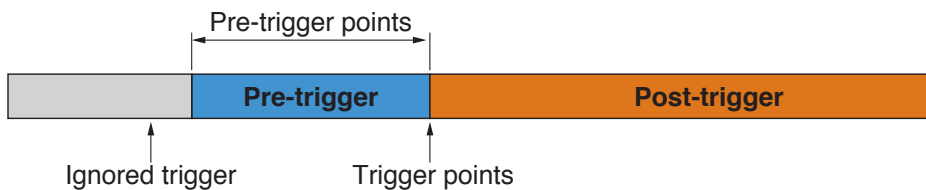



#### (4)-4 Repeated capturing

This is used to enable or disable the repeat function to conduct repeated capturing.

Selection item	Description
Off	The repeat function is disabled.
On	The repeat function is enabled. After one capture is ended, the next capture is started (If the start side source setting is not Off, this device waits for a trigger).

Repeat capture is available when the capturing destination is internal RAM or when the stop trigger is set.

#### Repeat interval mode and repeat interval

When the repeat capture function is set to On, you can set the time interval until the next capturing is started. The time interval range is set in repeat interval mode.

< Repeat interval mode >

Setting	Description
Start - Start	Set the time from the previous capture start (including waiting for trigger) to the start of this capture.
Stop - Start	Set the time from the previous capture stop to the start of this capture.

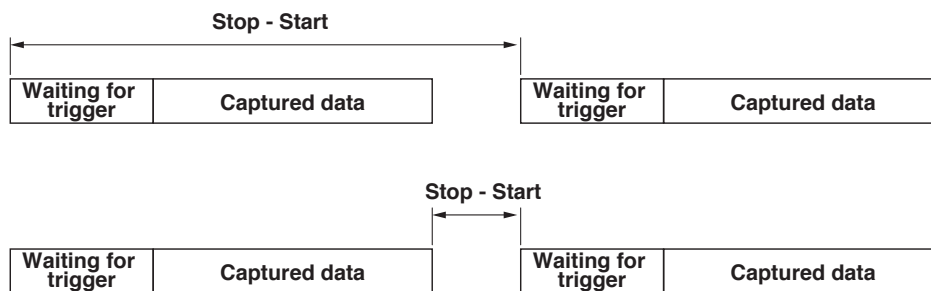

When the time interval between start and start is set and the already set time interval has passed at the end of the capturing, repeat operation is started immediately.

When the repeat interval is set to 0 hour 0 minute 0 second, repeat operation is immediately started.

#### CAUTION

The repeat interval may be longer than the set time.

### (4)-5 Alarm settings

#### **Alarm level settings**

This is used to set the alarm generation conditions and output destination, etc.

When the conditions specified here are met, the alarm output terminal (for which an output destination number must be specified for each channel) outputs an alarm.

For the CH condition settings, refer to "Trigger Level Settings/Alarm Level Settings" described below.

#### **Alarm occurrence hold**

If "Alarm occurrence hold" is selected here, once the established conditions have been met, the alarm status will not be cleared, regardless of whether or not the conditions continue to be met

(Press the [CURSOR] key to cancel it).

#### **Output 1 selection**

Select Alarm output 1 or Trigger output.

Setting	Description
Alarm output 1	Alarm output 1 is output from the Alarm output 1/Trigger output terminal.
Trigger output	Trigger is output from the Alarm output 1/Trigger output terminal.

### Trigger level settings/Alarm level settings

Specifies detailed conditions for each channel when the start and stop side source settings are Level. The configuration of the level trigger is as shown in the figure below.

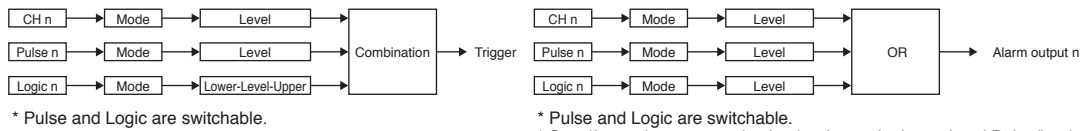

Example: If you specify 1 as the output destination of 1CH and 2CH and 2 as that of 3CH and 4CH, Alarm Output 1 occurs when one of 1CH and 2CH meets the conditions, and Alarm Output 2 occurs when one of 3CH and 4CH meets the conditions.

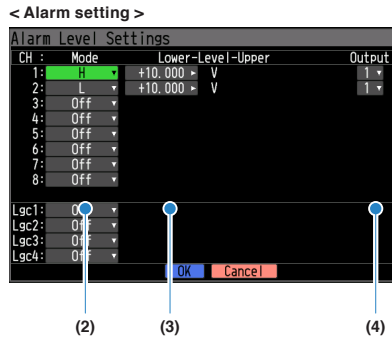
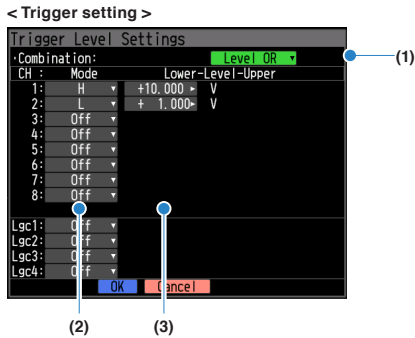

Setting	Description
(1) Combination	Set the combination of the trigger condition set for each channel. Level OR: Starts (stops) capturing when a set trigger condition is satisfied. The level operation is determined by each condition. Level AND: Starts (stops) capturing when all the set trigger conditions are satisfied. The level operation is determined by each condition. Edge OR: Starts (stops) capturing when a set trigger condition is satisfied. The each operation is determined by each condition. Edge AND: Starts (stops) capturing when all the set trigger conditions are satisfied. The each operation is determined by each condition. * Only for trigger setting.
(2) Mode	Set the mode to compare trigger/alarm for each channel. Off: Trigger/alarm of set CH is disabled. H (Rising): Trigger/alarm is established when the input signal exceeds the set level. L (Falling): Trigger/alarm is established when the input signal is lower than the set level. Window In: Trigger/alarm is established when the input signal is within the range between the upper level and lower level. * Logic CH has no setting. Window Out: Trigger/alarm is established when the input signal is out of the range between the upper level and lower level. * Logic CH has no setting.
(3) Level	Set the level to compare trigger/alarm. Set the comparison level to one place when the mode is H (Rising) or L (Falling). Set the comparison level to two places when the mode is Window In or Window Out.
(4) Output	Set the alarm output CH when an alarm occurs. * Only for alarm setting

- \* The operation in parentheses ( ) is for edge operation.
- \* When the alarm is set, the level operation is fixed.

### Level and Edge operations

In the Level operation, a trigger is assumed to be generated if the trigger conditions are met when the [START] key is pressed.

In the Edge operation, a trigger is not assumed to be generated even if the trigger conditions are met when the [START] key is pressed.

A trigger is assumed to be generated when the trigger conditions, after not being met, are met again.

\* A trigger is still assumed to be generated even if the trigger conditions are met once in the Edge operation and then are no longer met.

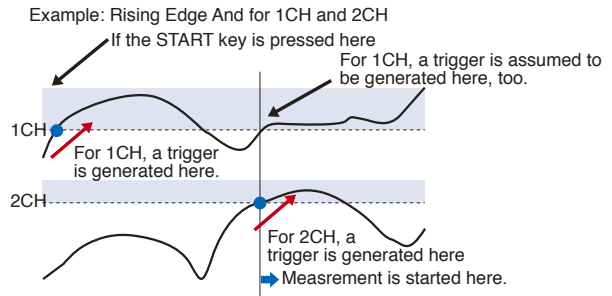
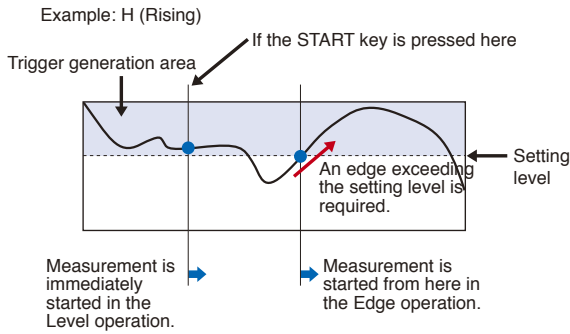

### Trigger and Alarm operations (H (Rising), L (Falling), Window In, Window Out)

H (Rising) : A trigger/alarm is generated when the input signal is higher than the specified level.

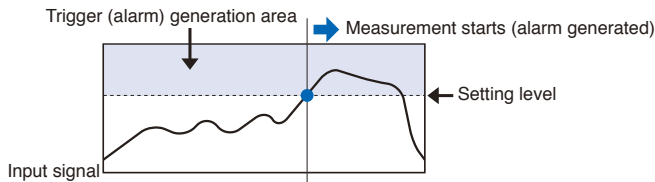

L (Falling) : A trigger/alarm is generated when the input signal is lower than the specified level.

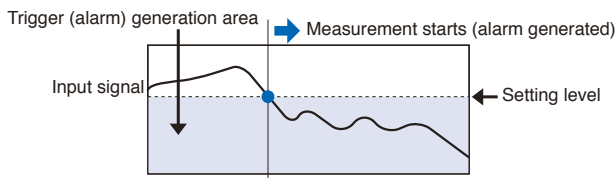

Win In : Used to specify the upper and lower limits. When the input signal level is (or comes) between these limits, a trigger/alarm is generated.

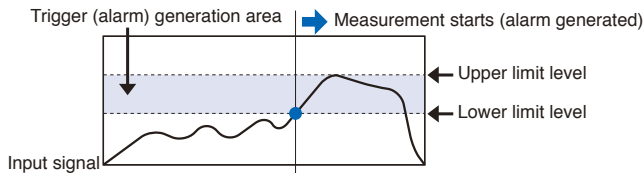

Win Out : Used to specify the upper and lower limits. When the input signal level is (or goes) out of these limits, a trigger/alarm is generated.

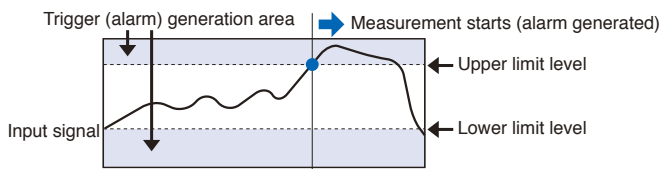

### Dead zones (hysteresis) of trigger and alarm levels

Trigger and alarm levels are provided with a dead zone (hysteresis) in order to prevent false detection due to noise.

The following figure shows the dead zone (hysteresis).

< Mode: H (Rising) >

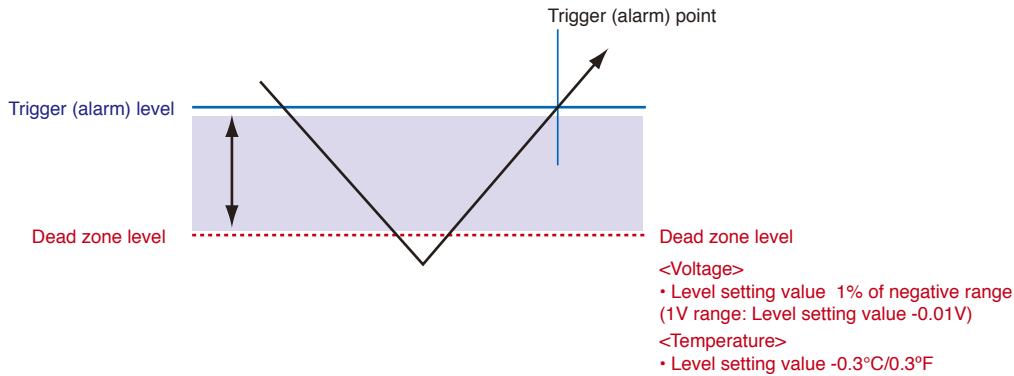

< Mode: L (Falling) >

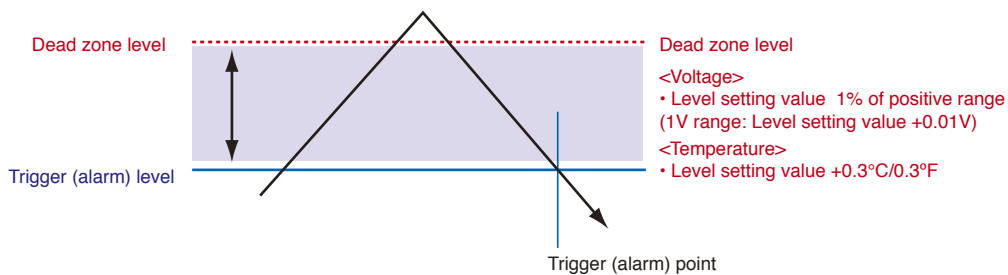

#### **CHECKPOINT**

- The upper limit values within the mode range and the lower limit values out of the mode range are dead zone level as well.
- When the detected alarm drops below the dead zone level, it is cleared. (When the alarm is not retained)  
 <Example>When measuring temperature, the level released after the alarm generated is shown below.
  - H (Rising) setting: Setting value -0.3°C/0.3°F
  - L (Falling) setting: Setting value +0.3°C/0.3°F
- In the case of pulse, dead zone is not provided.

## Logic trigger

The trigger of logic CH is compared with the pattern against setting for logic 4CH set in the mode.

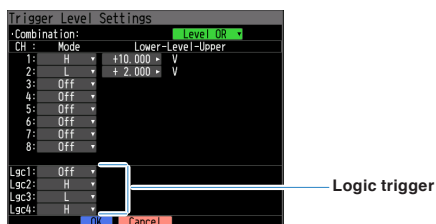

A trigger occurs when the input signal matches the set pattern.

Logic CH set to Off becomes “Don’t Care”, and it is regarded as a pattern match even if the input signal is H or L.

However, when all logic CHs are set to Off, the logic trigger is invalid and is not used.

## Specified time setting

By setting the repeat range, you can repeatedly set the time the trigger occurs.

Time setting range	Settable area	Description
Absolute time	Year, Month, Day, Hour, Minute, Second	Specify the absolute time. The trigger is output only once.
Year	Month, Day, Hour, Minute, Second	The trigger is output once a year.
Month	Day, Hour, Minute, Second	The trigger is output once a month.
Day	Hour, Minute, Second	The trigger is output once a day.
Hour	Minute, Second	The trigger is output once an hour.
Minute	Second	The trigger is output once a minute.

If the absolute time is set using the specified time trigger when trigger repeat setting is set to On, no trigger occurs at repeat operation. (Because trigger occurs only once.)

To properly set the repeat setting, please be sure to set other than the absolute time.

Example:

Specified time range: hour

Time: 12 minutes 34 seconds

A trigger occurs every 12 minutes and 34 seconds.

1 hour 12 minutes 34 seconds

15 hours 12 minutes 34 seconds

A trigger occurs every hour as described above.

## (5) Interface settings

This menu is used to specify conditions for PC connection.



Setting			Selection available	
End-of-line character			Set the end-of-line character for sending and receiving the control commands. CR + LF, CR, LF	
USB settings	USB ID		Set the identification ID when connecting between PC and USB. 0 to 9	
TCP/IP settings	TCP/IP Detailed	IPAddr Auto Acq.	Set the IP address automatic acquisition. On, Off	
		IP Address	Set the IP address. 0 to 255 . 0 to 255 . 0 to 255 . 0 to 255 * When the IP address is set automatically, the automatically set IP address is displayed.	
		Sub-net mask	Set the subnet mask. 0 to 255 . 0 to 255 . 0 to 255 . 0 to 255 * When the IP address is set automatically, the automatically set sub-net mask is displayed.	
		Port number	Set the port number of the control command server. 1024 to 65535 * This is the port number specified when connecting our application (GL980-2000_APS).	
		Gateway	Set the gateway. 0 to 255 . 0 to 255 . 0 to 255 . 0 to 255 * When the IP address is set automatically, the automatically set gateway address is displayed.	
		DNS address	Set the address of the DNS server. 0 to 255 . 0 to 255 . 0 to 255 . 0 to 255 * When the IP address is set automatically, the automatically set DNS server address is displayed.	
		Keep Alive	Set the forced disconnection time when no communication is detected by the control command server. Off, 10 seconds, 30 seconds, 1 minute, 10 minutes, 30 minutes, 1 hour	
	FTP/WEB server settings	FTP server port number		Set the port number of the FTP server installed in this device. 0 to 65535
		WEB server port number		Set the port number of the WEB server installed in this device. 0 to 65535
	Email settings	E-mail Send Settings	Destination settings	To
CC1 to CC3				Set the destination of the E-mail (broadcast 1 to 3). Enter the string of up to 63 characters.
Subject				Set the subject of the E-mail. Enter the string of up to 63 characters.

Setting			Selection available	
		Notification settings	Alarm	Set the E-mail send when an alarm occurs. Off, On
			Low battery	Set the E-mail send when the internal battery lowers. Off, On
			Drive free space	Set the E-mail send when the drive free capacity during recording is low. Off, On
			Periodic notifications	Set the periodic notification E-mail send. Off, 1 hour, 2 hours, 3 hours, 6 hours, 12 hours, Specified time * You can set the specified time to the hour : minute : second.
	E-Mail Send Server Settings	Send (SMTP) Server Name	Set the E-mail Send Server Name (server address). Enter the string of up to 63 characters. * Enter the domain name or IP address. * Enter the server name notified from the mail provider.	
		SMTP port number	Set the port number of the E-mail Send Server. 0 to 65535 * Enter the port number notified from the mail provider.	
		Time zone	Set the time zone. UTC-12:00 to UTC+13:00 * It is common setting with time zone setting of POP3 server setting and NTP setting.	
		SMTP authentication method	Set the SMTP authentication method. Off, POP before SMTP, SMTP-AUTH	
		SMTP-AUTH	Set the authentication method of SMTP-AUTH. PLAIN, LOGIN, CRAM-MD5, DIGEST-MD5	
		POP3 server settings	You can set it when POP before SMTP is selected in SMTP authentication method.	
		Receive (POP3) Server Name	Set the E-mail receiving server name (server address). Enter the string of up to 63 characters. * Enter the domain name or IP address. * Enter the server name notified from the mail provider.	
		POP3 port number	Set the port number of the E-mail receiving server. 0 to 65535 * Enter the port number notified from the mail provider.	
		Time zone	Set the time zone. UTC-12:00 to UTC+13:00 * It is common setting with the time zone setting of SMTP server setting and NTP setting.	
		POP3 encryption	Set the encryption of POP3 server. Off, StartTLS, Over SSL * Set the encryption notified from the mail provider.	
		The same as SMTP	Set whether to use the same POP3 user name and POP3 password as SMTP user name and SMTP password. No, Yes	
		POP3 user name	Set the user name to log in to the POP3 server. Enter the string of up to 63 characters.	
		POP3 password	Set the password to log in to the POP3 server. Enter the string of up to 63 characters.	
		SMTP user name	Set the user name to log in to the SMTP server. Enter the string of up to 63 characters.	
		SMTP password	Set the password to log in to the SMTP server. Enter the string of up to 63 characters.	
		SMTP encryption	Set the encryption of the SMTP server. Off, StartTLS, Over SSL * Set the encryption notified from the mail provider.	
		E-mail Address	Set your own E-mail address. Enter the string up to 63 characters.	
Test email	A test E-mail is sent.			
Identification name	Set the distinguished name to be used in our application (GL980-2000_APS). Enter the string of up to 15 characters.			
Apply Settings	Confirm TCP/IP settings and restart TCP/IP processing.			



### **(5)-1 End-of-line character**

Specifies the line feed code.

Selection item	Description
CR+LF	Starts a new line with CR+LF code (default value).
LF	Starts a new line with LF code.
CR	Starts a new line with CR code.

\* For details of I/F command, refer to GL980/GL2000-SDK.

### **(5)-2 USB settings**

Set the USB ID number of this product.

You can set the range between 0 and 9.

When controlling multiple devices with one PC, set so that the USB ID does not overlap.

(5)-3 TCP/IP advanced settings

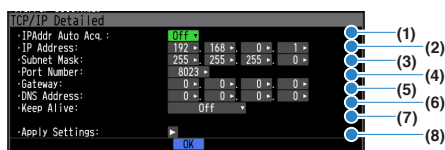

Setting	Description
(1) IPAddr Auto Acq.	Set the IP address automatic acquisition. On, Off
(2) IP Address	Set the IP address. 0 to 255 . 0 to 255 . 0 to 255 . 0 to 255 * When the IP address is set automatically, the automatically set IP address is displayed.
(3) Sub-net mask	Set the subnet mask. 0 to 255 . 0 to 255 . 0 to 255 . 0 to 255 * When the IP address is set automatically, the automatically set sub-net mask is displayed.
(4) Port number	Set the port number of the control command server. 1024 to 65535 * This is the port number specified when connecting to our application (GL980-2000_APS).
(5) Gateway	Set the gateway. 0 to 255.0 to 255.0 to 255.0 to 255 * When IP address is set automatically, the automatically set gateway address is displayed.
(6) DNS address	Set the address of the DNS server. 0 to 255 . 0 to 255 . 0 to 255 . 0 to 255 * When the IP address is set automatically, the automatically set DNS server address is displayed.
(7) Keep Alive	Set the forced disconnection time when no communication is detected by the control command server. Off, 10 seconds, 30 seconds, 1 minute, 10 minutes, 30 minutes, 1 hour If no communication state continues for specified time or more, the socket connection is disconnected. You should generate a communication within the set time. When using the supplied application software, note that it will be the non-communication state while the captured data is being replaying. (This function is available only for the control command server, and does not affect the Web server function and FTP server function.)
(8) Apply Settings	Confirm TCP/IP setting and restart TCP/IP processing.

**CAUTION**

- If the Automatic IP Address Acquisition fails (see the figure below), the IP address is not set properly. Disable the Auto IP Address Acquisition and make the settings one by one.
- After you have changed the TCP-IP settings, turn off and on the power or execute Reflect Settings (The connection will be forcibly disconnected).
- When you want to use the IP address automatic acquisition function, the DHCP server must be operating separately within the searchable network.

< Auto IP Address Acquisition is successful >



< Auto IP Address Acquisition fails >

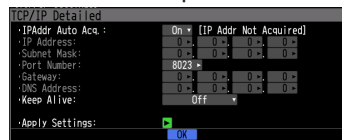

### (5)-4 FTP/WEB server settings

Set the FTP server/WEB server for the backup destination.

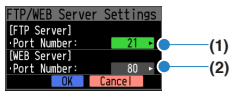

Setting	Description
FTP server port number	Set the port number of the FTP server installed in this device. 0 to 65535
WEB server port number	Set the port number of the WEB server installed in this device. 0 to 65535

### (5)-5 Mail settings

Perform the settings for mailing from this device.

When mail send setting is completed, notification setting content (Alarm, low battery, drive low capacity (only during capturing)) is sent. Also, when periodic notification is set, it is sent according to the set time.

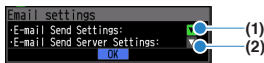

#### (1) Mail send settings

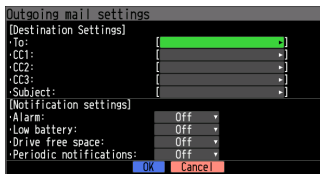

Setting		Description	
Outgoing mail settings	Destination Settings	TO	Set the destination (address) of the E-mail. Enter the string of up to 63 characters.
		CC1 to CC3	Set the destination of the E-mail (broadcast 1 to 3). Enter the string of up to 63 characters.
		Subject	Set the subject of the E-mail. Enter the string of up to 63 characters.
	Notification settings	Alarm	Set the E-mail send when an alarm occurs. Off, On
		Low battery	Set the E-mail send when the internal battery lowers. Off, On
		Drive free space	Set the E-mail send when the drive free capacity during recording is low. Off, On
		Periodic notifications	Set the periodic notification E-mail send. Off, 1 hour, 2 hours, 3 hours, 6 hours, 12 hours, Specified time * You can set the specified time to the hours : minutes : seconds.

(2) Mail send server settings

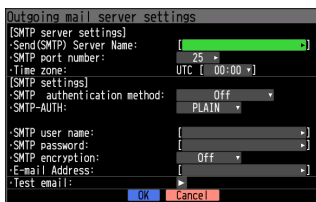

	Setting	Description
Outgoing mail settings	Send (SMTP) Server Name	Set the E-mail Send Server Name (server address). Enter the string of up to 63 characters. * Enter the domain name or IP address. * Enter the server name notified from the mail provider.
	SMTP port number	Set the port number of the E-mail Send Server. 0 to 65535 * Enter the port number notified from the mail provider.
	Time zone	Set the time zone. UTC-12:00 to UTC+13:00 * It is common setting with time zone setting of POP3 server setting and NTP setting.
	SMTP authentication method	Set the authentication method of SMTP-AUTH. PLAIN, LOGIN, CRAM-MD5, DIGEST-MD5
	SMTP-AUTH	Set the SMTP authentication method. Off, POP before SMTP, SMTP-AUTH
	POP3 server settings	You can set it when POP before SMTP is selected in SMTP authentication method. Set the user name to log in to the SMTP server. Enter the string of up to 63 characters.
	SMTP user name	Set the user name to log in to the SMTP server. Enter the string of up to 63 characters.
	SMTP password	Set the password to log in to the SMTP server. Enter the string of up to 63 characters.
	SMTP encryption	Set the encryption of the SMTP server. Off, StartTLS, Over SSL * Set the encryption notified from the mail provider.
	E-mail Address	Set your own E-mail address. Enter the string up to 63 characters.
	Test email	A test E-mail is sent.

## (3) &lt; Incoming mail server settings &gt;

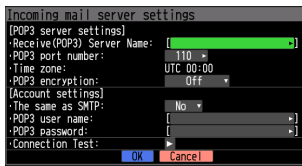

	Setting	Description
Incoming mail server settings	Receive (SMTP) Server Name	Set the E-mail Receive Server Name (server address). Enter the string of up to 63 characters. * Enter the domain name or IP address. * Enter the server name notified from the mail provider.
	SMTP port number	Set the port number of the E-mail Receive Server. 0 to 65535 * Enter the port number notified from the mail provider.
	Time zone	Set the time zone. UTC-12:00 to UTC+13:00 * It is common setting with time zone setting of POP3 server setting and NTP setting.
	POP3 encryption	POP3 encryption Set the encryption of POP3 server. Off, StartTLS, Over SSL * Set the encryption notified from the mail provider.
	The same as SMTP	Set whether to use the same POP3 user name and POP3 password as SMTP user name and SMTP password. No, Yes
	POP3 user name	Set the user name to log in to the POP3 server. Enter the string of up to 63 characters.
	POP3 password	Set the password to log in to the POP3 server. Enter the string of up to 63 characters.

When the authentication of the send (SMTP) server is set to “POP Before SMTP”, you must log in to the POP3 server before accessing the send (SMTP) server.

Set the information to log in to POP3 server to the mail receive server.

However, only login to the receive server is performed and mail is not received.

---

**CAUTION**

**When the mail is received, the mail is deleted from the mail server.**

**In order not to delete important mails, please use a dedicated e-mail account (e-mail address).**

---

### (5)-6 Identification name

Set the identification name to be used with our application.

The identification name entered here will be displayed as the device name on the device search screen of our application.

## (6) OTHER settings

Various conditions can be set.



Setting		Description	
LCD brightness		Set the brightness of the LCD backlight. Light, Medium, Dark	
Screen Saver		Set the time the screen saver will start up. Off, 10, 30s; 1, 2, 5, 10, 30, 60min	
Power On Start		Set whether to automatically start capturing when the power is turned on. Disable, Enable	
Over voltage protection (Free Running)		Set the overvoltage detection function. Off, On	
TEMP. Settings	Room Temp	Set the room temperature compensation for temperature measurement. Internal, External	
	Temp. Unit	Set the unit of temperature. °C, °F	
Background Color		Set the background color on the screen. Black, White	
Confirm Start/Stop		Set the confirmation message display when starting/stopping capturing. Off, On	
Function key settings		Set the operation of the FUNC key.	
Function key settings	Y-T displayed	Free run	Always select, NAVI, Screen copy, Alarm clear, Pulse integration clear, Internal RAM clear, Auto save cancel
		Recording	Always select, Screen copy, Alarm clear, Pulse integration clear, Immediately back up
		Replaying	Always select, Screen copy, Alarm clear, Pulse integration clear, Search next, Search previous, Cursor synchronization, Auto save cancel
	Logging displayed	Free run	Always select, NAVI, Screen copy, Alarm clear, Pulse integration clear, Internal RAM clear, Statistical operation clear, Auto save cancel
		Recording	Always select, Screen copy, Alarm clear, Pulse integration clear, Immediately back up
	XY displayed	Free run	Always select, NAVI, Screen copy, Alarm clear, Internal RAM clear, XY display clear, Auto save cancel
		Recording	Always select, Screen copy, Alarm clear, Immediately back up
		Replaying	Always select, Screen copy, Alarm clear, Auto save cancel
	Date/Time	Date/Time	Set the current date and time. Year, month, day, hour, minute, second
Internet time		Internet time	Off, On
		Internet time	Set the Internet time (NTP). Off, On
		NTP server	Set the time server (NTP server). Enter the character string of up to 127 characters
		Time Zone	Set the time zone. UTC-12:00 to UTC+13:00 * This setting is the same as the time zone setting of SMTP server setting and POP3 server setting.
		Synchronized Time	Set the time for time synchronization. 0 hour 00 minute to 23 hour 59 minute
		Adjust Mode	Set the adjust mode. Immediately, Slowly
Connection Test	Perform a connection test to the time server (NTP server).		
Language		Set the display language. Japanese, English (US), English (UK), French, German, Chinese, Korean, Russian, Spanish	
Return to default settings		Return the settings to the default settings.	

Setting	Description
Information	Various version information and MAC address are displayed.
Demo waveform	Set the demo waveform mode. Off, On
NAVI functions	Start up the NAVI functions.

### (6)-1 LCD brightness

Set the brightness (three stages of bright, middle, and dark) of the LCD backlight.

### (6)-2 Screen Saver

Select the time (eight stages of 10 s to 60 min.) you want to specify. The screen is switch to Off state automatically when the non-operation state continues for a predetermined period.

Turns off the display if not operated for some time to extend the service life of the LCD screen.

If this device runs on a battery pack (B-569, option), the use of this function prolongs the drive time.

### (6)-3 Power On Start

Sets the feature which initiates measurement as soon as this device is turned on.

Setting	Description
Disable	When turning On the power, the capture is started automatically.
Enable	Even when turning On the power, the capture is not started automatically.

### (6)-4 Overvoltage detection function

Set the function to reduce damage of this device when overvoltage is applied.

Setting	Description
Off	Even if overvoltage is detected, the range is not changed.
ON	In Free Running, when the voltage exceeding the set range is detected, the range is automatically changed to 500V.

#### CAUTION

- This function is effective only during free running.  
It is not effective during capturing and remote (connected to PC).
- This function is effective when the set range is in the range of 20mV to 2V.  
It is not effective when the set range is 5V or more.
- This function is intended to reduce damage at overvoltage, but is not the function to protect damage.  
Depending on the input voltage, the input circuit may be damaged, so please be careful not to input overvoltage.  
(For details of overvoltage, refer to "2.12 Precautions to Observe When Performing Measurement".)

### (6)-5 Temperature settings

Set the items related to temperature.

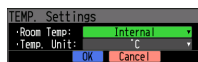

#### **Room temperature compensation**

Set whether thermocouple room temperature (terminal temperature) compensation of this device is used or not.

Setting	Description
Internal	Room temperature compensation of this device is enabled. (Normally you should select this.)
External	Set it when compensating for room temperature with external equipment.

#### **Temperature unit**

Switch between °C (Celsius) and °F (Fahrenheit) units when setting the temperature.

°F (Fahrenheit) is calculated by the following formula.

$$^{\circ}\text{F (Fahrenheit)} = ^{\circ}\text{C (Celsius)} \times 1.8 + 32$$

When checking accuracy, calculate with Celsius accuracy x 1.8.

### (6)-6 Background Color

Set the background colors of the waveform display area and the digital display area.

### (6)-7 Start/Stop confirmation message

Set whether to display the confirmation message at start/stop.

Setting	Description
Off	Confirmation message is not displayed when starting/stopping.
On	Confirmation message is displayed when starting/stopping.



**(6)-8 FUNC key settings**

Set the behavior when the function key is pressed.

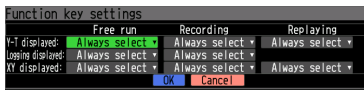

FUNC key can be set according to each screen mode (Y-T/logging/XY) and operating status (free running/capturing/replaying) respectively.

By pressing the FUNC key, the setting contents are executed immediately.

The contents that can be set in each status are listed below. The "○" mark in the table indicates that setting is possible.

Setting items		Free Run	Recording	Replaying
X-T	NAVI	○	×	×
	Screen copy	○	○	○
	Alarm clear	○	○	○
	Pulse operation clear	○	○	○
	Internal RAM clear	○	×	×
	Next search	×	×	○
	Prev. search	×	×	○
	Cursor synchronization	×	×	○
	Auto save cancel (only when saving automatically)	○	×	○
	Immediately back up (only when backup is set to On)	×	○	×
Logger	NAVI	○	×	No status
	Screen copy	○	○	No status
	Alarm clear	○	○	No status
	Pulse operation clear	○	○	No status
	Internal RAM clear	○	×	No status
	Statistical operation clear	○	×	No status
	Auto save cancel (only when saving automatically)	○	×	No status
	Immediately back up (only when backup is set to On)	×	○	No status
XY	NAVI	○	×	×
	Screen copy	○	○	○
	Alarm clear	○	○	○
	Pulse operation clear	○	○	○
	Internal RAM clear	○	×	×
	XY display clear	○	×	×
	Auto save cancel (only when saving automatically)	○	×	○
	Immediately back up (only when backup is set to On)	×	○	×

When "Always select" is set, items marked with "○" are displayed according to the status when pressing the FUNC key. Use the the ▲ ▼ keys to select the item you want to perform. Press the ENTER key to perform the content you selected.

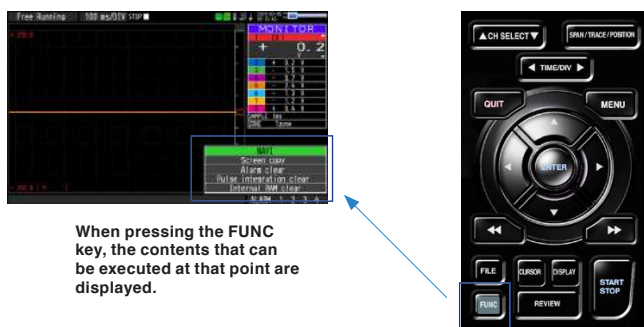

### (6)-9 Date/Time

Makes settings related to this device clock.

The internal clock (date and time) of this device can be set. Alternatively, if the Network Time setting is used, this device clock can be automatically adjusted via the network. Refer to the next section, "Network Time Setting" for details.

#### Network time

This device has a function to synchronize with time of clock server via Ethernet.

Using this function, set the Network time.

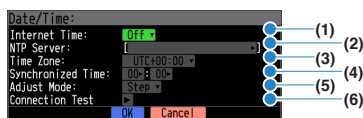

Setting	Description
(1) Internet Time	Set whether to use this function or not. Off: This function is not used. Time adjustment is not performed. On: Use this function to adjust the time.
(2) NTP Server	Enter the domain name (or IP address) of the time server (NTP server) to be used.
(3) Time Zone	Set the time zone in the area where this device is used. (Japan: +09□00) * This setting is the same as the time zone setting of SMTP server setting and POP3 server setting.
(4) Synchronized Time	Set the time to synchronize with the server. When the set time comes, the time synchronization operation is performed by the method set in the synchronous mode.
(5) Adjust Mode	Set the method to synchronize to the time server. Immediately: When the synchronization time comes, this device is immediately adjusted to the time of the time server. Slowly: Even if the synchronization time comes, this device is not synchronized immediately. This device gradually synchronizes with the time of the time server. The adjustment is approx. 43 seconds per day. (Adjustment of approx.10 ms in 20 seconds.)
(5) Connection Test	Perform a connection test to the time server (NTP server).

#### CAUTION

Synchronization is not performed if the time difference with the time server is 500 ms or less.

### (6)-10 Language

Set the display language (9 languages of Japanese, English (US), English (UK), French, German, Chinese, Korean, Spanish and Russian).

In addition, when this setting is changed, "CSV decimal point" and "CSV delimiter" of the CSV file are initialized.

Language	CSV decimal point	CSV delimiter
Japanese	Period (.)	Comma (,)
English(US)	Period (.)	Comma (,)
English(UK)	Period (.)	Comma (,)
French	Comma (,)	Semicolon (;)
German	Comma (,)	Semicolon (;)
Korean	Period (.)	Comma (,)
Chinese	Period (.)	Comma (,)
Russian	Comma (,)	Semicolon (;)
Spanish	Comma (,)	Semicolon (;)

### (6)-11 Return to default settings

Returns all the settings to the factory defaults. When initialized, setting conditions to return to the factory default settings.

### (6)-12 Information

The system information is displayed.

### (6)-13 Demo Waveform Mode

This parameter displays demo waveforms without inputting analog signal.

Setting	Description
Off	The demo waveform is not displayed.
On	The demo waveform is displayed.

### (6)-14 NAVI function

Operate the screen display procedure to perform capturing and trigger settings.



Setting	Description
Easy capture setting	The conditions (input, range, sapling and capturing destination, etc.) for data measurement and data capture can be set in accordance with the instructions displayed on the screen.
Easy trigger setting	The settings (trigger) for data capture can be set in accordance with the instructions displayed on the screen.

You can set it by following the instructions displayed on the menu.

## (7) FILE menu

The operations for file can be performed by pressing the [FILE] key.

The displayed items vary depending on Backup Off/On or Auto save or XY screen.



### (7)-1 File Operation

On this screen, you can operate files of internal memory, SD card or USB memory.

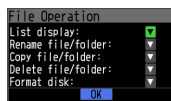

Operation mode	Operations
List display	The detailed file and folder information (file name, date, and time) are displayed.
Rename file/folder	Change the file name or folder name. The name can be changed by selecting the capture file or folder. Refer to Character string input in page 3-58 to operate the file and folder names.
Copy file/folder	Copy the file or folder. Select the capture file or folder (Multiple files/folders can be selected) you want to copy, and then select the copy destination (another folder, etc.), operate the Select/Execute of the copy destination.
Delete file/folder	Delete the file or folder. Select the capture file or folder (Multiple files/folders can be selected) you want to delete and then operate the Delete Execute.
Format disk	Initialize the internal memory (SD1) or SD card (SD2).

### <Example of operation procedure>

Example of file/folder delete procedure is described.

(1) Select the file/folder you want to delete.



Move the cursor to the file or folder you want to delete and then press the [ENTER] key. The "v" mark is displayed in the checkbox. (Multiple files/folders can be selected)

Press the [ENTER] key again to cancel it.

When it is cancelled, the "v" mark will disappear.

The selection is completed by pressing the [QUIT] key.

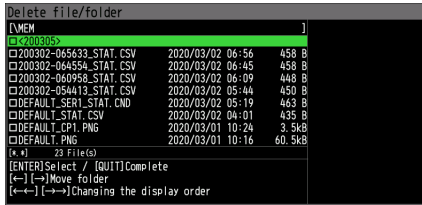

(2) Enable the deletion.

The message of "Delete the file. All the data will be lost. Are you sure?" is displayed.



The files are deleted by operating the [ENTER] key again.

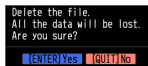

**(7)-2 Data Save**

Data saved in internal RAM can be saved.

During data replaying, you can save the data that is being replayed.

**When saving in internal RAM**

< When saving in internal RAM >

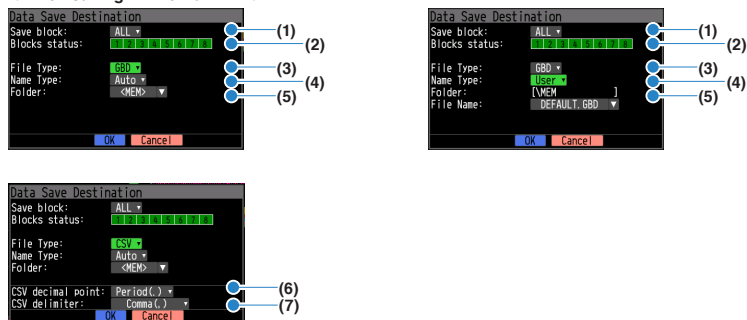

Setting		Description
(1) Save block		Select the internal RAM block to be saved. 1 to 8, ALL Numbers vary depending on the number of block divisions. When ALL is selected, the block in which all the data exists is saved.
(2) Blocks status		The status of the internal RAM is displayed.
(3) File Type		Set the file format of data. GBD: The data file is created in our own binary format. * Data cannot be changed. CSV: The data file is created in text format.
(4) Name Type		Set the naming method for the data file. Auto: File name is appended automatically. Example) 20170201-123456.GBD Numbers part ..... Date and time when the file was created * Example: 2017 year 2 month 1 day 12 hour 34 minute 56 second GBD ..... Data format GBD (binary data) CSV (text format) Arbitrary: Data is captured with the file name you entered. Serial number: File is created by appending a serial number to the arbitrarily entered file name.
	[Auto] (5) Folder	Set the folder of the saving destination.
	[Arbitrary] (5) Folder [Serial number] File	Set the file name of the data. The folder for saving the file is displayed in the Folder.
(6) CSV decimal point		Set the decimal point character of the CSV file. Period (.), Comma (,)
(7) CSV delimiter		Set the delimiter of the CSV file. Comma (,), Tab (Tab), Semicolon (;)

**During data replaying**

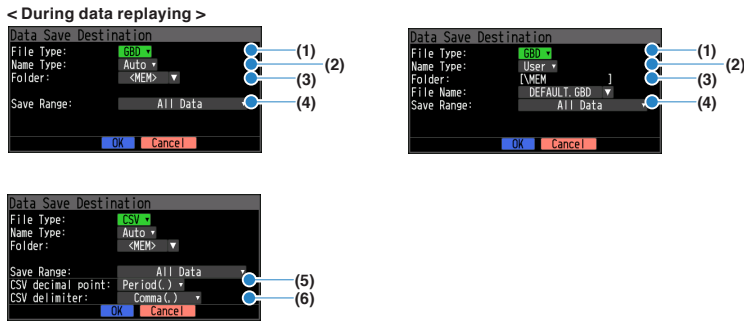

Setting	Description
(1) File Type	Set the file format of data. GBD: The data file is created in our own binary format. * Data cannot be changed. CSV: The data file is created in text format. * While GBD file is being replayed, you can duplicate it to a GBD file and convert it to a CSV file. * While CSV file is being replayed, you can copy to CSV file, but conversion to GBD file cannot be performed.
(2) Name Type	Set the naming method for the data file. Auto: File name is appended automatically. Example) 20170201-123456.GBD Numbers part ..... Date and time when the file was created * Example: 2017 year 2 month 1 day 12 hour 34 minute 56 second GBD ..... Data format GBD (binary data) CSV (text format) Arbitrary: Data is captured with the file name you entered. Serial number: File is created by appending a Serial number to the arbitrarily entered file name.
[Auto]	(3) Folder Set the folder of the saving destination.
[Arbitrary] [Serial number]	(3) Folder File Set the data file name. The folder for saving the file is displayed in the Folder.
(4) Save Range	Set the range of data to be saved. All Data: All the data is saved regardless of the cursor. Data between cursors: Data of the range between A and B cursors is saved.
(5) CSV decimal point	Set the decimal point character of the CSV file. Period (.), Comma (,)
(6) CSV delimiter	Set the delimiter of the CSV file. Comma (,), Tab, Semicolon (;)

**(7)-3 Immediate backup**

Perform backup processing immediately.

During capturing, you can use this function when backup setting is set to On.

Select the Immediate Backup and press [ENTER] key to perform the backup process immediately regardless of the backup interval set in the backup setting.

\* If the amount of data to be backed up increases by combining the sampling interval and backup interval, it may take time to perform the backup process.

### (7)-4 Remove/replace SD card/USB memory

The SD card/USB memory can be replaced during backing up the data in it. Perform the card replacement according to the following procedure.

- (1) Press the [FILE] key to open the FILE menu.
- (2) Press [ENTER] key to perform "Remove/replace SD card/USB memory."



- (3) Make sure that the message is displayed and then remove the SD card/USB memory.

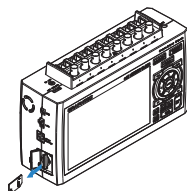
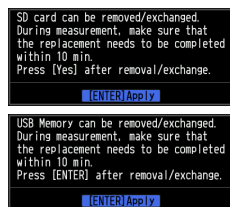

When SD card is attached

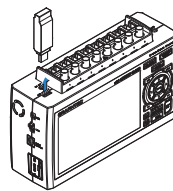

When USB memory is attached

#### CAUTION

Do not remove the SD card/USB memory until this message is displayed.  
Data may become corrupt and inaccessible.

- (4) Insert the new SD card/USB memory.

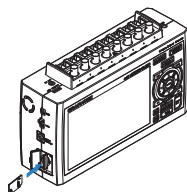
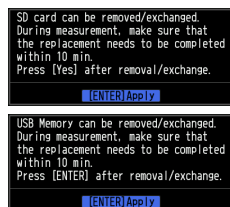

When SD card is attached

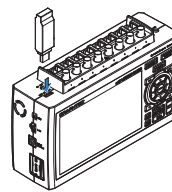

When USB memory is attached

- (5) Make sure that the device access indicator turns green and then press [ENTER] key. For access to device access indicator, refer to "3.1 Window names and functions".

#### CAUTION

Please perform the replacement operation within the displayed time in the message. If the displayed time is exceeded, the data will be missing.

#### CHECKPOINT

Each time the SD card/USB memory is replaced, the \_CHG number is added to the backup file name.

Exmpl : When backing up with backup file name " TEST\_BAK2.GDB"

1st SD card/USB memory: TEST\_BAK2.GBD

2nd SD card/USB memory: TEST\_BAK2\_CHG1.GBD



**(7)-5 Cancel auto save**

Auto save process can be cancelled when the capturing destination is set to internal RAM and Auto save is performed.

Select "Cancel auto save" and press [ENTER] key to cancel the auto save process.

**(7)-6 XY overwrite**

Perform XY overwrite settings.

You can select it when XY screen is displayed.



Setting	Description
(1) Select File	Select the image file to be XY-overwritten and perform XY overwrite. The image file is a screen copy of the file menu being XY-displayed, and the storage range is the image file saved as the waveform screen.
(2) Overwrite clear	Erase the XY overwritten image and finish the XY overwrite.

For details, refer to "3.5 Setting Menus" - "(3) DISP settings" - "(3)-3 XY display" - "XY overwrite".

**(7)-7 Screen copy**

Save the copy image of the display screen in the internal memory/SD card/USB memory.

**Specify save destination**

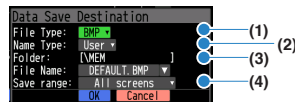
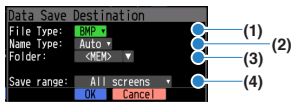

Setting	Description
(1) File Type	Set the file format of image data. BMP: Image data is created in BMP format. PNG: Image data is created in PNG format.
(2) Name Type	Set the naming method for the data file. Auto: File name is appended automatically. Example) 20170201-123456.GBD Numbers part ..... Date and time when the file was created * Example: 2017 year 2 month 1 day 12 hour 34 minute 56 second BMP ..... Data format BMP (BMP format) PNG (PNG format) Arbitrary: Data is saved with the file name you entered. Serial number: Image data file is created by appending a serial number to the arbitrarily entered file name.
[Auto]	(3) Folder Set the folder of the saving destination.
[Arbitrary] [Serial number]	(3) Folder File Set the data file name. The folder for saving the file is displayed in the Folder.
(4) Save range	Set the range of the image data to be saved. All screens: The entire screen is saved as image data. Waveform screen: Only the waveform display part is saved as image data.

**Execution**

Execute the screen copy to save the image data file in the saving destination set in "Specify save destination".

### (7)-8 Save/Read the current setting

Save and read the current setting.

You can save the settings separately to the operation setting and the communication setting.

#### Save

Save the setting conditions for this device.



Setting	Description
(1) Save details	Set the details of saved data setting. Operation setting: Settings related to the operation of this device are saved. Communication setting: Settings related to the communication are saved.
(2) Name Type	Set the naming method for the data file. Auto: File name is appended automatically. Example) 20170201-123456.GBD Numbers part ..... Date and time when the file was created * Example: 2017 year 2 month 1 day 12 hour 34 minute 56 second CND ..... Data format (file format set in this device) Arbitrary: Data is saved with the file name you entered. Serial number: Image data file is created by appending a serial number to the arbitrarily entered file name.
[Auto]	(3) Folder Set the folder of the saving destination.
[Arbitrary] [Serial number]	(3) Folder File Set the file name of the setting file. The folder for saving the file is displayed in the Folder.

#### Read

Read the setting conditions for this device from the file.

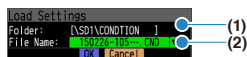

Setting	Description
(1) Folder	Specify a folder to which you want to save data.
(2) File	Specify a file to which you want to save data.

**(7)-9 File selection/Operation tool**

This tool is used for file selection and operation such as list display of file menu and data saving destination of DATA menu.

The operation method is as follows.

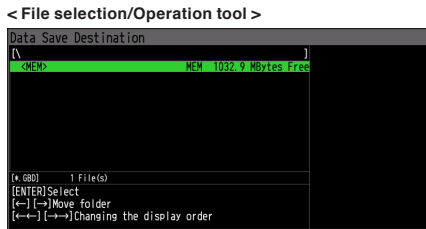

Key	Description
◀ ▶	Moves between folders. ◀ : Move up one folder. ▶ : Move down one folder.
◀◀ ▶▶	The display order can be changed.
ENTER	Finalize the operation.
QUIT	Close the file box. (The selection is confirmed in the copy and delete operation.)

**Create new folder**

To create a new folder, move to the folder where you want to create the folder, select [Create new folder], and then press [ENTER] key.

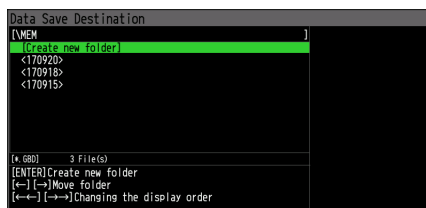

The character string input tool starts up. Enter a folder name.  
After confirming the folder name, a folder is created.

## Thumbnail display

If there are waveform screen data saved automatically when data is captured by this device, the waveform screen data is displayed as a thumbnail when files are listed.

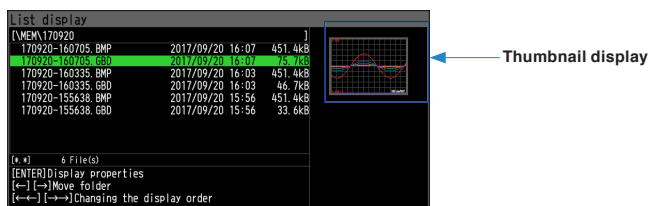

If there is a BMP file with the same file name as the data file, the thumbnail is displayed. (The image data only for thumbnail saved by this device are supported.)

### < Saving thumbnail images when data is captured >

When the data capturing destination is the internal memory/SD card/USB memory, the screen copy of the waveform screen displayed at the end of data capturing with the same file name as the data file is performed.

When the capturing destination is internal RAM, thumbnail files are not created.

In addition, as part of the ending process of the data capture, a copy of the waveform screen that is displayed on the screen at this point is created. Therefore, depending on the sampling interval and Time/DIV setting, it may not match the last waveform of the data file.

**(7)-10 Character string enter tool**

The tool is used to enter the character string such as folder name, file name, annotation character string, unit of EU (scaling), etc.

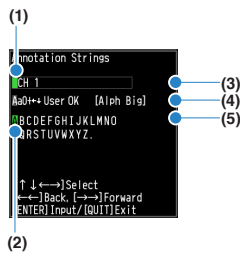

Display Item	Operation	Description	
(1) Character string selection cursor		This is the cursor that indicates the position to edit the character string you enter.	
(2) Input selection cursor		This is the cursor to select the input operation.	
(3) Character string entry field		An input character string is displayed. The character string cursor is shown in the character to be edited.	
(4) Operation selection	A	Upper case alphabet mode	This mode is for entering upper case alphabets.
	a	Lower case alphabet mode	This mode is for entering lower case alphabets.
	0	Numeric mode	This mode is for entering numbers.
	ア	Half-width Kana mode	This mode is for entering half-width Kana. (only when setting Japanese)
	+	Symbol mode	This mode is for entering symbols.
	←	One character delete	One character on the character string selection cursor is deleted.
	↓	One character insert	One character space is inserted on the character string selection cursor.
	User	User defined character string mode	Enter the user defined character string.
	OK	Confirm	Confirm the edited character string and close the tool.
(5) Character selection	Input character of each mode	Move the input selection cursor and select the input character.	

**< Moving character string cursor >**

(1) Use the ◀◀ and ▶▶ keys to move the cursor.

**< Operation selection (selection of character type) >**

(1) Press the ▲ key several times to move the enter selection cursor to the operation selection line.

(2) Use the ◀ and ▶ keys to select the operation (character type).



**< Enter character selection >**

- (1) Select the character type to be entered in operation selection.
- (2) Use the ▼ key to move the enter selection cursor to the character selection field.
- (3) Use the ▼, ▲, ◀, ▶ keys to move the enter selection cursor to the character you want to enter.
- (4) Use [ENTER] key to enter a single character.

The entered character is overwritten by the character string cursor and the character string cursor moves one character to the right.



**< Confirmation of entered character string >**

- (1) Press the ▲ key several times to move the enter selection cursor to the operation selection line.
- (2) Select [OK] with the ◀▶ keys and confirm it with [ENTER] key.

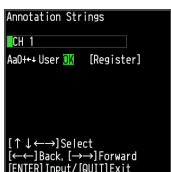

**< User character string enter >**

- (1) Select "User" in operation selection.
- (2) Use the ▼ ▲ keys to move to the user character string you want to enter.
- (3) Enter the user character string with [ENTER] key.

In the enter user character string, the character string from the character string cursor is overwritten. The character string cursor moves one character to the right from the overwritten character string.

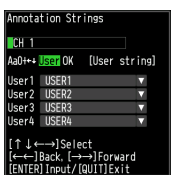

**< User character string change >**

- (1) Select "User" in operation selection.
- (2) Use the ▼ ▲ keys to move to the user character string you want to change.
- (3) Select "▼" by pressing ► key.
- (3) Press [ENTER] key to display the character string enter tool for user character string editing.  
There is no user string in this tool.
- (4) After editing the user character string, confirm the character string.



## (8) Data replay menu

Select the data you want to replay from the “Data replay source” by pressing the [REVIEW] key and replay the captured data.

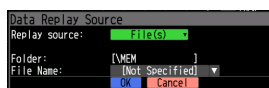
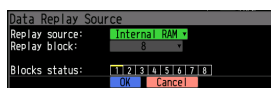

Press [MENU] key during replaying to display the data replaying menu.

< Y-T replay >



< XY replay >

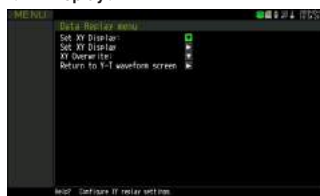

### Y-T replay

Setting		Description	
Cursor Position	Move to First	Move the selection cursor to the top of the data.	
	Move to Last	Move the selection cursor to the end of the data.	
	Move to Center	Move the selection cursor to the middle position of the data.	
	Move to Trigger	Move the selection cursor to the position where the trigger occurred.	
	Move to Selected	Selection method	Set the method to specify the destination. Position, Time
		[Position]	Moving position Specify the movement position as relative time from the trigger point.
		[Time]	Moved date/time Specify the moving point by date and time of the data.
Call Other Cursor	Move the other cursor to the position of the currently selected cursor.		
Cursor Sync	Set the synchronous movement of the cursor. Off, On		
Data Search	Combination	Set a combination of search conditions. Edge OR, Edge AND	
	Mode	[Analog CH]	Off, Rising, Falling, Window In, Window Out
		[Logic CH]	Off, H, L * Logic CH is used for pattern comparison of all the logic CH.
		[Pulse CH]	Off, Rising, Falling, Window In, Window Out
		[Alarm]	Off, Output 1, Output 2, Output 3, Output 4
	Level settings	Enter the search level as a numerical value. If it is within the range/out of range, you should set two places.	
Next Search	Search the next (future) position matching the search condition from the current cursor position.		
Prev. Search	Search the previous (future) position matching the search condition from the current cursor position.		
Statistical Calculation	Execute the statistical calculation between cursors.		
Set XY Display	Perform the settings for XY display.		
CH	CH	Set X-axis and Y-axis of XY graph. CH1 to CH8	
	Trace	Set the trace of XY graph. Off, On Waveforms are not displayed on the screen when the trace is set to Off. Also it is not displayed on the monitor display.	
	Position	Set the XY position. 0 to 100%	
	Vernier	Set the XY Vernier. 40 to 100% * The range varies depending on the range setting.	
	Span	Set the Span. You can set it when the analog CH in the Span mode is set to the axis.	



Setting	Description
Run All Data XY	Execute XY display for all data. * When the amount of data is large, it may take time to draw XY graph.
Run Cursors XY	The data of the section sandwiched between cursors AB is XY-displayed. * When the amount of data is large, it may take time to draw XY graph.

### XY replay

Setting	Description
Set XY Display	Perform settings for XY display.
CH	Set X-axis and Y-axis of XY graph. CH1 to CH8
Trace	Set the trace of XY graph. Off, On Waveforms are not displayed on the screen when trace is set to Off. Also they are not displayed on the monitor display.
Position	Set the XY position. 0 to 100%
Vernier	Set the XY Vernier. 40 to 100% * The range varies depending on the range setting.
Span	Set the Span. You can set it when the analog CH in the Span mode is set on the axis.
Reflect XY display settings	The XY graph with the contents of XY display settings is redrawn. * When the amount of data is large, it may take time to draw.
XY Overwrite	Set the XY overwrite.
Select File	Select the image file to be overwritten and execute overwriting.
Overwrite clear	The XY overwrite is cleared and completed.
Return to Y-T waveform screen	The data being replayed is changed to Y-T display.

### (8)-1 Move to selected position

Set the position (relative time with the trigger point set as 0) or the time and then move the currently selected cursor (A or B) to the position.

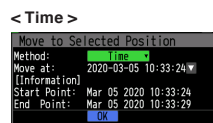
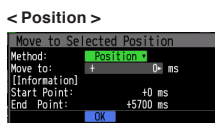

### (8)-2 Cursor synchronization

Set function that move two cursors in synchronization.

Setting	Description
Off	Cursors are not synchronized. Only the specified one cursor moves.
On	Two cursors move in synchronization.

\* Cursor Synch is turned Off when you move a cursor using the Move to Selected Position or performing Data Search.

### (8)-3 Data search

Set the conditions for data search.

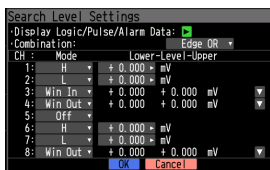

For details of the Combination and Mode and Level, refer to "3.5 Setting Menus" - "(4) TRIG settings" - "Trigger level settings/Alarm level settings".

Alarm CH is searched when the specified alarm output turns On.

After setting the search conditions, perform a search by selecting "Search for next" and "Find previous".

### (8)-4 Statistical calculation between cursors

Perform the statistical calculation between cursors.

The statistical calculation of the section between the cursors A and B is performed.

As soon as the calculation process is completed, the result is displayed.

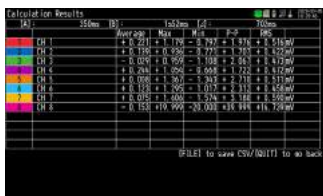

Setting	Description
Average	Displays the simple average value between cursors.
Max	Displays the maximum value between cursors.
Min	Displays the minimum value between cursors.
Peak	Displays the peak value between cursors.
RMS	Displays the RMS value between cursors. The calculation formula is as follows: $R.M.S = \sqrt{\sum D^2/n}$ * D: data n: number of data

Press the [FILE] key during displaying the result to save the calculation result in CSV format.

\* The specifying method of storage location and file name is the same as the file specifying method of captured data.

### **(8)-5 XY display settings**

Perform XY display setting when starting XY execution.

For details, refer to "3.5 Setting Menus" - "(3) DISP settings" - "3 XY display". This is a common setting.

You can set it again during XY replaying.

### **(8)-6 XY Execution**

Perform XY display according to the XY display settings.

All data XY execution: XY display is executed for all data that is being replayed.

XY execution between cursors: XY display is executed for data between cursors A and B.

\* When the amount of data is large, it may take time to draw the waveform of XY display.

### **(8)-7 Reflecting XY display**

When XY display setting is changed during XY replaying, XY waveform is redrawn for reflection of XY display setting.

\* When the amount of data is large, it may take time to draw the waveform of XY display.

### **(8)-8 XY overwrite**

Perform XY overwrite settings.

For details, refer to "3.5 Setting Menus" - "(3) DISP settings" - "3 XY display" - "XY overwrite ". This is a common setting.

### **(8)-9 Change to Y-T display**

Perform Y-T display with data that is being executed currently in XY display.

## 3.6 WEB Server Function

This function allows operating and monitoring device via a Web browser.

- Supported Web browsers
  - Microsoft Internet Explorer 11 or later
  - Firefox 1.5 or later
- Available functions using a Web browser
  - Operating this device
  - Monitoring this device's display screen
  - Enlarging this device's display screen
  - Linking to FTP
  - Linking to our Web site

• Setting the URL

The URL (Uniform Resource Locator) must be correctly set according to your network environment.

When the port number is changed, enter the following:

http://(IPAddress): (port number)/index.html

- http ..... Protocol to access the server.  
 HTTP (Hyper Text Transfer Protocol)
- IP address ..... Enter the IP address of this device to be monitored.
- Port number ..... Specify the port number.  
 The port number is the number set to this device or the router, etc.
- Index.html ..... This is the file name. This file name is fixed to index.html.

### CHECKPOINT

- **The port number can be omitted. In this case, the port number is 80.**  
 http://(IPAddress): 80/index.html
- **It is not possible to simultaneously WEB connection from multiple browsers. Please use a single browser for one device.**

• **Procedure**

1. Open the Web browser.



2. Enter the URL (http://IPAddress/index.html) in the address.

3. The following screen is displayed.



Remote key operation..... This device can be remotely operated.

Screen display ..... The screen of this device is displayed large. You can easily operate this device.

Digital display..... Measured value is displayed digitally.

Downloading files in this device... Data captured in this device can be downloaded to the PC using the FTP function.

Graphtec's homepage ..... Links to our homepage.

### Remote operation



KEY LOCK ..... Sets and cancels key lock.

PASSWORD ..... Sets and cancels a password.

Screen update rate ..... Sets an update rate of the screen.

The screen update rate can be set either to 2, 3, 5, 10 seconds.

Click the key displayed on this device to control remotely this device.

## Screen display



KEY LOCK ..... Sets and cancels key lock.

PASSWORD ..... Sets and cancels a password.

Screen update rate ..... Sets an update rate of the screen.

The screen update rate can be set either to 2, 3, 5, 10 seconds.

This operation is the same as remote operation, but the screen is displayed in four times larger.

## Digital display



Screen update speed ..... Specifies the speed in which the screen is updated.

Available update speeds are 3, 5, 10, 20, 30 seconds, 1, 5, 10, 20, 30 minutes, 1 hour

## Downloading files in this device

This allows you to download the data saved in the internal memory/SD card/USB memory to the PC.

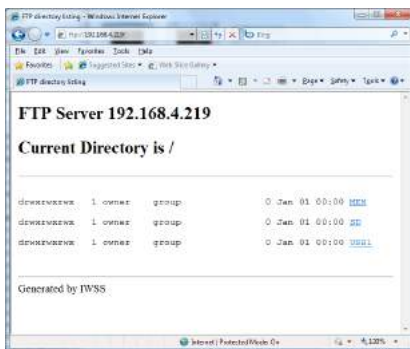

To display the FTP site from the above figure with Explorer, press the [Alt] key, click [View], and click [Open FTP site in Explorer]. The following screen is displayed.

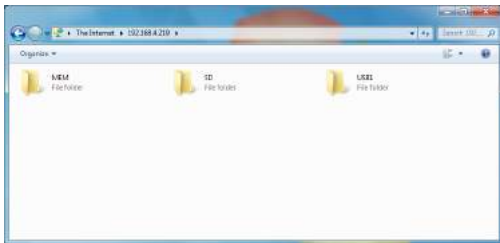

## **CHECKPOINT**

To display the FTP site with Explorer, it is necessary to set the Internet option in advance.

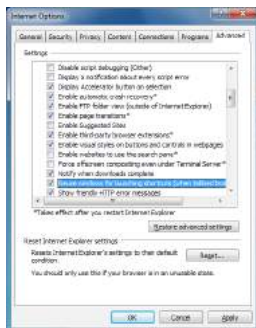

Check "Internet Options" - "Advanced Settings Tab" - "Browse" - "Enable FTP Folder View" checkboxes.

**<FTP server functions>**

When connecting with FTP using Internet Explorer, login is automatically performed using an anonymous account and the files become read-only files.

The following operations cannot be performed for read-only files:

- Upload file
- Delete file/folder
- Create file/folder
- Change file name/folder name

To write the data to this device, the login account name must be changed.

Please use the following table as a guide.

<b>Account name</b>	<b>Password</b>	<b>Restrictions</b>
GL980	None	None
gl980	None	None
Anonymous	Any	Read-only

The account cannot be changed in Internet Explorer.

Please use FTP application which can set the account separately.



## 3.6 List of Error Codes

If an error code is displayed on this device, please handle errors in reference to the table below.

Error code	Description
-1	Unexpected error
1	Please contact us.
2	File not found. The operation target is not a folder.
3	Hardware error There is a possibility that the hardware has failed. Please contact us.
5	There is a possibility that the internal memory (SD1) or SD card (SD2) has failed.
8	Please contact us.
9	Please contact us.
12	Please contact us.
13	Light Protected state. Please check the write-protect switch of the SD card.
16	Please contact us.
17	File/folder already exists. The error code is displayed when you created a folder with the folder name that already exists.
21	The target is not a file. You tried to perform the file operation for a folder.
22	The path name is too long.
23	Please contact us.
24	Please contact us.
27	Please contact us.
28	Please contact us.
46	Please contact us.
88	The disc format is not supported.
90	The target directory is not empty.
100	Please contact us.
101	Please contact us.
102	Please contact us.



# ***CHAPTER 4 Specification***

---

This chapter describes the basic specifications for this device.

## ***PRODUCT SUMMARY***

- 4.1 Standard Specifications***
- 4.2 Function Specifications***
- 4.3 Accessories/Optional Accessories***
- 4.4 External Dimensions***

## 4.1 Standard Specifications

Item	Description	
Number of analog CHs	8CH fixed	
External output terminal	Trigger input (1ch) or external sampling (1ch) Logic input (4ch) or pulse input (4ch) Alarm output (4ch) or trigger output (1ch) + alarm output (3ch) * Trigger input and external sampling input can be switched. * Alarm output and trigger output can be switched.	
PC I/F	Ethernet (10BASE-T/100BASE-TX) USB (compatible with high-speed) standard-included	
Internal memory device	Internal RAM : 4MW/CH Internal flash memory : Approx. 4GB Flash SD card slot : 1* (Compatible with SDHC, up to approx. 32GByte memory available) USB memory slot : 1* (compatible with high-speed)	
Data backup functions	Setting conditions: EEPROM/Clock: Lithium secondary battery	
Clock accuracy (23°C environment)	Network time setting Off: $\pm 0.002\%$ (monthly difference of approx. 50 seconds) Network time setting On: $\pm 0.01\%$ (day difference about 8.6 seconds) (Maximum error after synchronization)	
Operating environment	0 to 40°C, 5 to 85% RH (15 to 35°C when battery is used)	
Power supply	<ul style="list-style-type: none"> <li>AC adapter : 100 to 240 VAC, 50 to 60 Hz</li> <li>DC input : 8.5 to 24 VDC</li> <li>Battery pack (option) : 7.2 VDC (2900 mAh), two packs can be mounted</li> </ul>	
Power consumption • AC power consumption (when using the AC adapter provided as a standard accessory) When the LCD is on When the screen saver is operating • DC power consumption +24V When the LCD is on When the screen saver is operating +12V When the LCD is on When the screen saver is operating +8.5V When the LCD is on When the screen saver is operating	Normal	During recharging battery
	15W	24W
	13W	22W
	Normal	During recharging battery
	0.56A	0.86A
	0.48A	0.78A
	Normal	During recharging battery
	1.12A	Recharging not possible
	0.97A	Recharging not possible
	Normal	During recharging battery
	1.65A	Recharging not possible
	1.42A	Recharging not possible
* Normal condition: LCD brightness is set to MAX.		
External dimensions (approximate)	250(W)×161(H)×80(D) mm	
Weight (approximate) *1	1.4 kg	
Vibration proof	Automobile parts Type 1 Class A equivalent	

\*1: AC adapter and battery are not included.

**Internal RAM**

Item	Description
Memory capacity	4MW/CH volatile memory
Memory contents	Measured data
Sampling speed	1, 2, 5, 10, 20, 50, 100, 200, 500 $\mu$ s 1, 2, 5, 10, 20, 50, 100, 200, 500 ms 1, 2, 5, 10, 20, 30, 60s, External
Capturing settings	Set the number of capturing points Setting range: 10 to 4000000 points Input increment: 1 point increment
Pre-trigger	1 to 4000000 points (Points designation and Time display available)
Auto-save function	ON/OFF setting ON: Auto save to internal flash memory or USB memory OFF: Only temporary save in Internal RAM (When the power is turned off, data is erased.)
Memory division	Settable from 4MW x 1, 2MW x 2, 1MW x 4, 0.5MW x 8 divisions. (Overwrite ON/OFF setting available)

**Internal Flash memory**

Item	Description
Memory capacity	Approx. 4GByte Flash memory * Up to 4GB for 1 file
Memory contents	Setting condition for this device Measured data, Screen bitmap
Sampling speed	Fastest 1 ms/8 ch (when using GBD/CSV) 1, 2, 5, 10, 20, 50, 100, 200, 500 ms 1, 2, 5, 10, 20, 30, 60s, External

**USB Memory slot**

Item	Description
Memory capacity	No limit (however, up to 4GB for 1 file)
Memory contents	Setting condition for this device Measured data, Screen bitmap
Sampling speed	Fastest 1 ms/8 ch (when using GBD/CSV) 1, 2, 5, 10, 20, 50, 100, 200, 500 ms 1, 2, 5, 10, 20, 30, 60s, External

**SD card**

Item	Description
Memory capacity	Approx. 4GByte Flash memory * Up to 4GB for 1 file
Memory contents	Setting condition for this device Measured data, Screen bitmap
Sampling speed	Fastest 1 ms/8 ch (when using GBD/CSV) 1, 2, 5, 10, 20, 50, 100, 200, 500 ms 1, 2, 5, 10, 20, 30, 60s, External

**PC I/F**

Item	Description
Interface types	Ethernet (10BASE-T/100BASE-TX) USB 2.0
Functions	Data transfer to the PC (realtime, memory) PC control of this device
Ethernet functions (10BASE-T/100BASE-TX)	Web server functions: Displays the screen images FTP server function: Transfer/delete files in main unit's memory and SD card FTP client function: Correct time of main unit's clock DHCP client function: IP address automatic acquisition function Email sending function: Email sending (no receiving function)
USB functions	USB drive mode: Transfer/delete the files in built-in flash memory or SD card
Real time data transfer speed	Fastest 1 msec.

**Monitor**

Item	Description
Display	7-inch TFT color LCD (WVGA: 800 x 480 dots)
Displayed languages	Japanese, English, French, German, Chinese, Korean, Russian, Spanish
Backlight life	50,000 hrs (when brightness is down to 50%), depends on operation environment
Backlight	Screen saver function provided (10, 30 sec., 1, 2, 5, 10, 30, 60 min.)

## Input section

Item	Description																																																		
Number of input channels	8CH fixed																																																		
Input terminal type	Voltage	Insulated BNC connector or M3.5 screw terminal unit (However, it cannot input to the BNC connector of same CH and the screw terminal at the same time.)																																																	
	Temperature	M3.5 screw type terminals (Rectangular flat washer)																																																	
Input method	All CH insulation, unbalanced input, all CH simultaneous sampling																																																		
Fastest Sampling interval	1 $\mu$ s																																																		
Measurement ranges	Voltage	20, 50, 100, 200, 500 mV; 1, 2, 5, 10, 20, 50, 100, 200, 500 V; 1-5 V F.S.																																																	
	Temperature	Thermocouples : K, J, E, T, R, S, B, N, W (WRe5-26)																																																	
	Humidity	0 to 100% (Voltage 0 to 1V scaling conversion) * B-530 (option) used																																																	
	DC-RMS	10, 25, 50, 100, 250, 500 mVrms 1, 2.5, 5, 10, 25, 50, 100, 250 Vrms F.S. * Crest Factor 2 or less * Zero cross level setting function available																																																	
Measurement accuracy (23°C $\pm$ 5°C)	<ul style="list-style-type: none"> <li>• Voltage <math>\pm</math>0.25% of F.S.</li> <li>• Thermocouple</li> </ul> <table border="1"> <thead> <tr> <th>Thermocouple</th> <th>Measurement Temperature Range (°C)</th> <th>Measurement Accuracy</th> </tr> </thead> <tbody> <tr> <td rowspan="4">R/S</td> <td><math>0 \leq TS \leq 100^{\circ}\text{C}</math></td> <td><math>\pm 7.0^{\circ}\text{C}</math></td> </tr> <tr> <td><math>100 &lt; TS \leq 300^{\circ}\text{C}</math></td> <td><math>\pm 5.0^{\circ}\text{C}</math></td> </tr> <tr> <td>R : <math>300 &lt; TS \leq 1600^{\circ}\text{C}</math></td> <td><math>\pm (0.05\% \text{ of rdg} + 3.0^{\circ}\text{C})</math></td> </tr> <tr> <td>S : <math>300 &lt; TS \leq 1760^{\circ}\text{C}</math></td> <td><math>\pm (0.05\% \text{ of rdg} + 3.0^{\circ}\text{C})</math></td> </tr> <tr> <td rowspan="2">B</td> <td><math>400 \leq TS \leq 600^{\circ}\text{C}</math></td> <td><math>\pm 5.5^{\circ}\text{C}</math></td> </tr> <tr> <td><math>600 &lt; TS \leq 1820^{\circ}\text{C}</math></td> <td><math>\pm (0.05\% \text{ of rdg} + 3.0^{\circ}\text{C})</math></td> </tr> <tr> <td rowspan="2">K</td> <td><math>-200 \leq TS \leq -100^{\circ}\text{C}</math></td> <td><math>\pm (0.05\% \text{ of rdg} + 3.0^{\circ}\text{C})</math></td> </tr> <tr> <td><math>-100 &lt; TS \leq 1370^{\circ}\text{C}</math></td> <td><math>\pm (0.05\% \text{ of rdg} + 2.0^{\circ}\text{C})</math></td> </tr> <tr> <td rowspan="2">E</td> <td><math>-200 \leq TS \leq -100^{\circ}\text{C}</math></td> <td><math>\pm (0.05\% \text{ of rdg} + 3.0^{\circ}\text{C})</math></td> </tr> <tr> <td><math>-100 &lt; TS \leq 800^{\circ}\text{C}</math></td> <td><math>\pm (0.05\% \text{ of rdg} + 2.0^{\circ}\text{C})</math></td> </tr> <tr> <td rowspan="2">T</td> <td><math>-200 \leq TS \leq -100^{\circ}\text{C}</math></td> <td><math>\pm (0.1\% \text{ of rdg} + 2.5^{\circ}\text{C})</math></td> </tr> <tr> <td><math>-100 &lt; TS \leq 400^{\circ}\text{C}</math></td> <td><math>\pm (0.1\% \text{ of rdg} + 1.5^{\circ}\text{C})</math></td> </tr> <tr> <td rowspan="3">J</td> <td><math>-200 \leq TS \leq -100^{\circ}\text{C}</math></td> <td><math>\pm 3.7^{\circ}\text{C}</math></td> </tr> <tr> <td><math>-100 &lt; TS \leq 100^{\circ}\text{C}</math></td> <td><math>\pm 2.7^{\circ}\text{C}</math></td> </tr> <tr> <td><math>100 &lt; TS \leq 1100^{\circ}\text{C}</math></td> <td><math>\pm (0.05\% \text{ of rdg} + 2.0^{\circ}\text{C})</math></td> </tr> <tr> <td rowspan="2">N</td> <td><math>-200 \leq TS &lt; 0^{\circ}\text{C}</math></td> <td><math>\pm (0.1\% \text{ of rdg} + 3.0^{\circ}\text{C})</math></td> </tr> <tr> <td><math>0 \leq TS \leq 1300^{\circ}\text{C}</math></td> <td><math>\pm (0.1\% \text{ of rdg} + 2.0^{\circ}\text{C})</math></td> </tr> <tr> <td>W</td> <td><math>0 \leq TS \leq 2315^{\circ}\text{C}</math></td> <td><math>\pm (0.1\% \text{ of rdg} + 2.5^{\circ}\text{C})</math></td> </tr> <tr> <td colspan="2">Reference contact compensation accuracy</td> <td><math>\pm 1.0^{\circ}\text{C}</math></td> </tr> </tbody> </table> <p>* Thermocouple diameters T - K: 0.32 <math>\phi</math>, others: 0.65 <math>\phi</math></p> <ul style="list-style-type: none"> <li>• DC-RMS <math>\pm</math>1.5% of F.S. (Sine wave, 20 to 10 KHz)</li> </ul>	Thermocouple	Measurement Temperature Range (°C)	Measurement Accuracy	R/S	$0 \leq TS \leq 100^{\circ}\text{C}$	$\pm 7.0^{\circ}\text{C}$	$100 < TS \leq 300^{\circ}\text{C}$	$\pm 5.0^{\circ}\text{C}$	R : $300 < TS \leq 1600^{\circ}\text{C}$	$\pm (0.05\% \text{ of rdg} + 3.0^{\circ}\text{C})$	S : $300 < TS \leq 1760^{\circ}\text{C}$	$\pm (0.05\% \text{ of rdg} + 3.0^{\circ}\text{C})$	B	$400 \leq TS \leq 600^{\circ}\text{C}$	$\pm 5.5^{\circ}\text{C}$	$600 < TS \leq 1820^{\circ}\text{C}$	$\pm (0.05\% \text{ of rdg} + 3.0^{\circ}\text{C})$	K	$-200 \leq TS \leq -100^{\circ}\text{C}$	$\pm (0.05\% \text{ of rdg} + 3.0^{\circ}\text{C})$	$-100 < TS \leq 1370^{\circ}\text{C}$	$\pm (0.05\% \text{ of rdg} + 2.0^{\circ}\text{C})$	E	$-200 \leq TS \leq -100^{\circ}\text{C}$	$\pm (0.05\% \text{ of rdg} + 3.0^{\circ}\text{C})$	$-100 < TS \leq 800^{\circ}\text{C}$	$\pm (0.05\% \text{ of rdg} + 2.0^{\circ}\text{C})$	T	$-200 \leq TS \leq -100^{\circ}\text{C}$	$\pm (0.1\% \text{ of rdg} + 2.5^{\circ}\text{C})$	$-100 < TS \leq 400^{\circ}\text{C}$	$\pm (0.1\% \text{ of rdg} + 1.5^{\circ}\text{C})$	J	$-200 \leq TS \leq -100^{\circ}\text{C}$	$\pm 3.7^{\circ}\text{C}$	$-100 < TS \leq 100^{\circ}\text{C}$	$\pm 2.7^{\circ}\text{C}$	$100 < TS \leq 1100^{\circ}\text{C}$	$\pm (0.05\% \text{ of rdg} + 2.0^{\circ}\text{C})$	N	$-200 \leq TS < 0^{\circ}\text{C}$	$\pm (0.1\% \text{ of rdg} + 3.0^{\circ}\text{C})$	$0 \leq TS \leq 1300^{\circ}\text{C}$	$\pm (0.1\% \text{ of rdg} + 2.0^{\circ}\text{C})$	W	$0 \leq TS \leq 2315^{\circ}\text{C}$	$\pm (0.1\% \text{ of rdg} + 2.5^{\circ}\text{C})$	Reference contact compensation accuracy		$\pm 1.0^{\circ}\text{C}$
Thermocouple	Measurement Temperature Range (°C)	Measurement Accuracy																																																	
R/S	$0 \leq TS \leq 100^{\circ}\text{C}$	$\pm 7.0^{\circ}\text{C}$																																																	
	$100 < TS \leq 300^{\circ}\text{C}$	$\pm 5.0^{\circ}\text{C}$																																																	
	R : $300 < TS \leq 1600^{\circ}\text{C}$	$\pm (0.05\% \text{ of rdg} + 3.0^{\circ}\text{C})$																																																	
	S : $300 < TS \leq 1760^{\circ}\text{C}$	$\pm (0.05\% \text{ of rdg} + 3.0^{\circ}\text{C})$																																																	
B	$400 \leq TS \leq 600^{\circ}\text{C}$	$\pm 5.5^{\circ}\text{C}$																																																	
	$600 < TS \leq 1820^{\circ}\text{C}$	$\pm (0.05\% \text{ of rdg} + 3.0^{\circ}\text{C})$																																																	
K	$-200 \leq TS \leq -100^{\circ}\text{C}$	$\pm (0.05\% \text{ of rdg} + 3.0^{\circ}\text{C})$																																																	
	$-100 < TS \leq 1370^{\circ}\text{C}$	$\pm (0.05\% \text{ of rdg} + 2.0^{\circ}\text{C})$																																																	
E	$-200 \leq TS \leq -100^{\circ}\text{C}$	$\pm (0.05\% \text{ of rdg} + 3.0^{\circ}\text{C})$																																																	
	$-100 < TS \leq 800^{\circ}\text{C}$	$\pm (0.05\% \text{ of rdg} + 2.0^{\circ}\text{C})$																																																	
T	$-200 \leq TS \leq -100^{\circ}\text{C}$	$\pm (0.1\% \text{ of rdg} + 2.5^{\circ}\text{C})$																																																	
	$-100 < TS \leq 400^{\circ}\text{C}$	$\pm (0.1\% \text{ of rdg} + 1.5^{\circ}\text{C})$																																																	
J	$-200 \leq TS \leq -100^{\circ}\text{C}$	$\pm 3.7^{\circ}\text{C}$																																																	
	$-100 < TS \leq 100^{\circ}\text{C}$	$\pm 2.7^{\circ}\text{C}$																																																	
	$100 < TS \leq 1100^{\circ}\text{C}$	$\pm (0.05\% \text{ of rdg} + 2.0^{\circ}\text{C})$																																																	
N	$-200 \leq TS < 0^{\circ}\text{C}$	$\pm (0.1\% \text{ of rdg} + 3.0^{\circ}\text{C})$																																																	
	$0 \leq TS \leq 1300^{\circ}\text{C}$	$\pm (0.1\% \text{ of rdg} + 2.0^{\circ}\text{C})$																																																	
W	$0 \leq TS \leq 2315^{\circ}\text{C}$	$\pm (0.1\% \text{ of rdg} + 2.5^{\circ}\text{C})$																																																	
Reference contact compensation accuracy		$\pm 1.0^{\circ}\text{C}$																																																	
Reference contact compensation accuracy	Internal/External switching																																																		
Burnout detection	Detectable in dedicated mode (Not detectable during capturing)																																																		
A/D converter	16-bit (Effective resolution: Approx. 1/40000 of the +/- range)																																																		
Temperature coefficient	Gain : 0.01% of F.S./°C Zero : 0.02% of F.S./°C																																																		
Input resistance	1M $\Omega$ $\pm$ 5%																																																		
Allowable signal source resistance	Within 1K $\Omega$																																																		
Maximum permissible input voltage	Between each input (+) terminal and each input (-) terminal: 20 mv to 2 V $\rightarrow$ $\pm$ 30 V 5 V 500 V $\rightarrow$ $\pm$ 500 V5																																																		
	Between each input (-) terminal and each input (-) terminal: 60Vp-p																																																		
	Between each input (-) terminal and GND terminal: 60Vp-p																																																		
Withstand voltage	Between each input (-) terminal and each input (-) terminal: 1000Vp-p 1 minute Between each input (-) terminal and GND terminal: 1000Vp-p 1 minute																																																		
Insulation resistance	Between Input Ch and GND terminal: 50M $\Omega$ or more (At 500 VDC )																																																		
Common mode rejection ratio	90 dB or more (50/60 Hz; signal source 300 $\Omega$ or less)																																																		

## CHAPTER 4 Specification

Item	Description
S/N (Noise)	20 mV range: -40 dB or more (at +/- short) Other range: -50 dB or more (at +/- short)
Frequency response	DC to 200 KHz (+1/-4 dB)
Filter	OFF, Line, 5 Hz, 50 Hz, 500 Hz, 5 KHz, 50 KHz (Attenuation) -3 dB/6 dB oct



## 4.2 Function Specifications

Item	Description
Display screen	Waveform + Monitor display All Waveform screen Logging + Calculation Display screen X-Y View * It is possible to open the menu even during capturing (Setting is impossible, for confirmation) * Switching by dedicated key (Toggle operation)
EU (scaling function)	Voltage : 4 points can be set for each channel Temperature : 2 points can be set for each channel (Offset function) Pulse : 2 points can be set for each channel (Gain function)
Functions during capture	Data during capturing can be replayed and displayed.
Data save function	Capturing destination: Built-in RAM/built-in memory/USB memory/SD card Captured data: Settings, screen data, measurement data, Integrated bar graph data (page)
Capture function	Function: OFF, Ring recording, Relay recording
Ring capturing	Capturing destination: Internal RAM/Internal flash memory/USB memory/SD card Number of capturing points: 1,000 to 10,000,000 (No need to set the number of capturing points when using Internal RAM) Sampling: Internal RAM maximum speed 1 $\mu$ s/other fastest 1 ms
Relay capturing	Capturing destination: Built-in flash memory, USB memory/SD card Number of capturing points: Fastest 1 ms
Backup function	Function: OFF, 1, 2, 6, 12, 24 hours; specified time * In addition to the above, backup can be performed by key operation
Backup destination	Internal flash memory, USB memory
Sampling	Fastest 1 ms
USB memory	Function to replace the USB memory for backup destination
SD card	Function to replace the SD card for backup destination
Statistical calculation (Real time)	Types of operation: Maximum value, minimum value, P-P value, Average value Number of calculations: 4 arithmetic operations are displayed simultaneously. Calculation method: Free running, during capturing) Sampling interval: No limit (fastest 1 $\mu$ s)
Statistical calculation (Between cursors)	Types of operation: Average value, maximum value, minimum value, P-P value, root mean square value Number of operations: 5 arithmetic operation results are displayed simultaneously. Calculation method: Calculation between cursors (during replaying)
Search functions	Function: Searches for the target point in the captured data. Search type: Search by level of each channel search by logic pulse + combination search by generated alarm
Annotation enter function	Function : A comment can be entered for each channel Enterable characters : Alphanumeric characters Number of characters : 31

### Trigger Functions

Item	Description
Repeat Trigger	Off, On
Repeat interval	Start to start interval, stop to start interval 1 second - 9999 hours 59 minutes 59 seconds
Trigger types	Start: Data capture starts when a trigger is generated. Stop: Data capture stops when a trigger is generated.
Trigger conditions	Start: Off, level, alarm, external input, specified time, specified day of the week, certain time, hourly Stop: Off, level, alarm, external input, specified time, specified day of the week, certain time * Level can be set to each CH.
Trigger judgment modes	Analog judgment: H/Rising, L/Falling, Window In, Window Out Logic judgment: H, L (Pattern comparison) Pulse judgment: H/Rising, L/Falling, Window In, Window Out
Trigger accuracy	±0.5% of range
Combination of channel	Level OR, Level AND, Edge OR, Edge AND

### Alarm Functions

Item	Description
Alarm judgment modes	Analog judgment: H, L, Window In, Window Out Logic judgment: H, L Pulse judgment: H, L, Window In, Window Out
Alarm detection cycle	Linked to the sampling interval (Fastest 1 μs)
Retention of alarm judgment mode	ON, OFF Setting available
Alarm accuracy	±0.5% of range
Combination of channel	Level OR fixed

## External Input/Output Functions

Item	Description
Input/output types	Trigger input (1 ch) or External sampling input (1 ch) Logic input (4 ch) or Pulse input (4 ch) Alarm output (4ch), or Trigger output (1ch) + Alarm output (3ch) * Trigger input and external sampling input can be switched. * Alarm output and trigger output can be switched.
Input specifications	Maximum input voltage : 0 to +30V (single-ended ground input) Input threshold voltage : Approx. +2.5V (logic input, pulse input) Approx. 1.9V (external trigger, external sampling) Hysteresis : Approx. 0.5V (+2.5V to $\pm 3.0V$ ) (Logic input, pulse input) Approx. 0.2V (+1.9V to $\pm 2.1 V$ ) (external trigger, external sampling)
Alarm output specifications	Output format: Open collector output (5 V, pull-up resistance 10K $\Omega$ ) Contact capacity 5V to 24V, 100mA or less (0.2W or less) Output conditions: Level judgment, window judgment, logic pattern judgment, pulse judgment
Trigger output	When a trigger is detected after trigger output is set, a pulse of 500 $\mu$ width is output from the Output 1 terminal. (Low active)
Pulse input	Pulse sampling interval: 10 $\mu$ s to 1h * Set it separately from sampling interval. Setting faster than sampling interval is not possible (constant multiple) Revolutions mode (engines, etc.) Function: Mode to convert to the number of revolutions per minute by applying magnification after counting the number of pulses for each pulse sampling interval. Spans: 50, 100, 200, 500, 1k, 2k, 5k 10k, 20k, 50k 100k, 200k, 500k, 1M, 2M, 5M, 10M, 20M, RPM/F.S. Counts mode (electric meters, etc.) Function: Mode to accumulate the number of pulses for each pulse sampling interval from the start of measurement Spans: 50, 100, 200, 500, 1k, 2k, 5k 10k, 20k, 50k 100k, 200k, 500k, 1M, 2M, 5M, 10M, 20M, RPM/F.S. Inst. mode Function: Mode to display the number of pulses for each pulse sampling interval. The accumulated value for each pulse sampling interval is reset. Span: 50, 100, 200, 500, 1k, 2k, 5k 10k, 20k, 50k 100k, 200k, 500k, 1M, 2M, 5M, 10M, 20M, RPM/F.S. Maximum number of pulse inputs Maximum input frequency : 100 kHz Maximum number of count : 15 MC (24-bit counter)
External sampling input	Maximum input frequency: 100 KHz Temporal error: 10 $\mu$ s or less.

## 4.3 Accessories/Optional Accessories

### Control Software

Item	Item
Compatible operating system	Windows10/Windows8.1/Windows8/Windows7
Function	Main unit control, realtime data capture, data conversion
Number of connected units	1 unit MAX
Settings	AMP settings, capture settings, trigger/alarm settings, others
Capturing to internal RAM	Binary: Sampling speed 1 $\mu$ sec. to 60 sec. * Transferring while capturing to internal RAM
Real time capturing	Binary: Sampling speed 1 msec. to 60 sec. CSV: Sampling speed 1 msec. to 60 sec.
Display	Analog waveforms, logic waveforms, pulse waveforms, digital values
Display modes	Y-T View, Y-Y View, Digital View
File conversion	Between cursors, All data
Statistic/History	Displays the maximum, minimum, average values, peak value

### Standard Accessories

Item	Remarks	Quantity
Quick Start Guide	GL980-UM-85x	1
CD-ROM	User's Manual, Application software	1
TO ENSURE SAFE AND CORRECT USE		1
AC cable/AC adapter	100 to 240 VAC, 50/60 Hz	1
Ferrite core	For attaching each cable	4
M3.5 Flat screw	For thin-type thermocouple	20
Tilt stand	Tilt stand x2, M4 screw x2, Spacer x3	1

### Standard Accessories

Item	Description
Battery type	B-569 (7.2V/2900mAh)
Running time	Install 2 batteries in this device (2 batteries required for battery operation) <8CH> LCD luminance MAX: Approx. 2 hours When screen saver is activated: Approx. 2.5 hours <4CH> LCD luminance MAX: Approx. 3 hours When screen saver is activated: Approx. 5 hours * Conditions 1-sec sampling, capturing to internal memory, new battery pack 2 pcs., +25°C environment.
Charging method	Mount in this device
Time required for charging	Battery pack x 1: approx. 5 hours Battery pack x 2: approx. 10 hours
Switchover in the event of a power failure	Because the battery is used together with the AC adapter, the power supply will be switched automatically to the battery in the event of a power failure. * The AC adapter is the primary power source.
Operation environment	Drive: 0 to 40°C, Charge: 15 to 35°C (power OFF) /15 to 25°C (power ON)
Other functions	<ul style="list-style-type: none"> <li>• When the battery is running low, file is closed automatically. (When capturing to internal memory, USB memory or SD card)</li> <li>• Automatic backup to internal memory when capturing to internal RAM</li> <li>• Remaining amount indicator</li> </ul>

List of Options

Item	Model	Description
Battery pack	B-569	7.2V/2900mAh
DC drive cable	B-514	2 m long (no clip on end of cable)
Input/output cable for GL	B-513	2 m long (no clip on end of cable)
Protect cover	B-579	
DIN rail mounting screw	B-570	Built to order
Storage case	B-581	
Humidity sensor *1	B-530	3 m long (with power plug)
Shunt resistor 250Ω	B-551	Built to order. ±250 Ω (0.1%), Rated power of 1 W, Maximum operating voltage 15.8V
Safety probe	RIC-141A	1:1 42pF, Length 1.2 m, 300VDC, CATII
Insulated BNC-BNC cable	RIC-142	Length 1.5 m, 1000VDC, CATII
Insulated BNC-banana cable	RIC-143	Length 1.6 m, 600VDC, CATII
Alligator clip (small)	RIC-144A	Aperture 11 mm, 300VDC, CATII, MAX15A
Alligator clip (medium)	RIC-145	Aperture 20mm, 1000VDC, CATII, MAX32A
Gran Bar clip	RIC-146	Aperture 5mm, 1000VDC, CATII, MAX1A
High withstand voltage insulated BNC-Banana cable	RIC-147	Length 1.6 m, 1000VDC, CATII
Safety adapter	SMA-102	Banana (female) → BNC conversion adapter (1 pc.)

\*1: Allowable temperature range: -25°C to + 80°C

\*2: Sold only in Japan



# INDEX

- A**
- AC ..... 3-8
  - AC Power Supply ..... 2-7
  - Active CH (priority display CH) ..... 3-30
  - Adjust Mode ..... 3-110
  - A/D resolution ..... 2-10
  - ALARM CLEAR ..... 3-24
  - Alarm display ..... 3-9
  - Alarm Functions ..... 4-8
  - Alarm level settings ..... 3-98, 3-99
  - Alarm occurrence hold ..... 3-98
  - Alarm Output ..... 2-11
  - Alarm settings ..... 3-98
  - AMP settings ..... 3-55
  - Analog settings ..... 3-57
  - Annotation Settings ..... 3-62
- B**
- Background Color ..... 3-112
  - Backup setting ..... 3-81
  - Battery status indicator ..... 3-8
- C**
- Cancel auto save ..... 3-121
  - Capture bar ..... 3-11
  - Capturing ..... 3-53
  - Capturing destination ..... 3-72
  - Capturing destination file name (auto save) ..... 3-76
  - Capturing destination file name (file capture) ..... 3-77
  - Capturing points ..... 3-75
  - Change to Y-T display ..... 3-131
  - Character string enter tool ..... 3-125
  - Charging the Battery ..... 2-20
  - Checking the Accessories ..... 2-2
  - CH GROUP ..... 3-17
  - Clock display ..... 3-7
  - Connecting to a PC ..... 2-17
  - Connection Using a USB Cable ..... 2-17
  - Control Software ..... 4-10
  - Create new folder ..... 3-123
  - CURSOR ..... 3-24
  - Cursor synchronization ..... 3-129
- D**
- Data RAM information ..... 3-9
  - Data replaying during capturing ..... 3-53
  - Data replay menu ..... 3-128
  - Data Save ..... 3-118
  - Data search ..... 3-130
  - DATA settings ..... 3-69
  - Date and Time ..... 2-27
  - Date/Time ..... 3-114
  - DC Power Supply ..... 2-8
  - Dead zones (hysteresis) of trigger and alarm levels ..... 3-101
  - Demo Waveform Mode ..... 3-115
  - Device access display ..... 3-6, 3-7
  - Digital display ..... 3-134
  - Digital display of measured value ..... 3-44
  - Direction Keys ..... 3-20
  - DISPLAY ..... 3-23
  - DISP settings ..... 3-82
  - DIV display ..... 3-15
  - DNS address ..... 3-106
  - Downloading files in this device ..... 3-135
- E**
- Edge operations ..... 3-100
  - End-of-line character ..... 3-105
  - ENTER ..... 3-20
  - Error Codes ..... 3-137
  - EU ..... 3-61, 3-67
  - External Input/Output Functions ..... 4-9
  - External Sampling Input ..... 2-11
- F**
- FAST FORWARD key ..... 3-20
  - FILE ..... 3-24
  - FILE menu ..... 3-116
  - File name display ..... 3-10
  - File Operation ..... 3-116
  - Filter ..... 2-10, 3-60, 3-66
  - Free Running ..... 3-52
  - FTP server settings ..... 3-107
  - FUNC ..... 3-25
  - FUNC key settings ..... 3-113
  - Function Specifications ..... 4-7
- H**
- How to attach and detach the rubber protector ..... 2-5
  - How to attach the tilt stand ..... 2-4
  - How to insert the SD card ..... 2-14
  - How to install USB memory ..... 2-16
  - How to remove the SD card ..... 2-15

**I**

Identification name ..... 3-109  
 Immediate backup ..... 3-119  
 Information ..... 3-115  
 Input ..... 3-57, 3-66  
 Input section ..... 4-5  
 Interface settings ..... 3-103  
 Internal Flash memory ..... 4-3  
 Internal memory ..... 3-6  
 Internal RAM ..... 4-3  
 Internal RAM clear ..... 3-74  
 IP Address ..... 3-106

**K**

KEY LOCK ..... 3-20  
 Key lock display ..... 3-7  
 Key lock release with password ..... 3-26  
 Key Operation ..... 3-17

**L**

LAN Connection ..... 2-18  
 Language ..... 1-6, 3-115  
 LCD brightness ..... 3-111  
 Level bar ..... 3-9  
 Level operations ..... 3-100  
 LOCAL ..... 3-19  
 Logging display ..... 3-12, 3-37, 3-86  
 Logic and Pulse settings ..... 3-66  
 Logic/Pulse ..... 3-66  
 Logic/Pulse Input ..... 2-11  
 Logic trigger ..... 3-102  
 L-R key mode and Cross key mode ..... 3-45

**M**

Mail settings ..... 3-107  
 Memory block division ..... 3-73  
 MENU ..... 3-21, 3-55  
 Misc. .... 3-68  
 Monitor ..... 4-4  
 Monitor display ..... 3-32  
 Monitor display of Y-T screen ..... 3-8  
 Mounting the Battery Pack ..... 2-19  
 Move to selected position ..... 3-129

**N**

NAVI function ..... 3-115  
 Nomenclature and Functions ..... 2-3

**O**

Operating Environment ..... 1-3  
 Optional Accessories ..... 4-10  
 Options ..... 4-11  
 Origin ..... 3-91  
 Other settings ..... 3-62  
 OTHER settings ..... 3-110  
 Output 1 selection ..... 3-98  
 Overvoltage detection function ..... 3-111  
 Overwrite mode ..... 3-73

**P**

PC I/F ..... 4-4  
 Pen status display ..... 3-13  
 Port number ..... 3-106  
 Power On Start ..... 3-111  
 Pre-trigger ..... 3-95  
 Pre-trigger mode ..... 3-95  
 Pulse sampling interval ..... 3-71

**Q**

Quick setting ..... 3-48  
 Quick settings ..... 3-8  
 QUIT ..... 3-19

**R**

Range ..... 3-57  
 RANGE mode ..... 3-39  
 Real time statistical calculation display ..... 3-37  
 Real time statistical calculations display ..... 3-12  
 Reflecting XY display ..... 3-131  
 Relay capture ..... 3-80  
 Remote lamp ..... 3-7  
 Remote operation ..... 3-133  
 Repeated capturing ..... 3-97  
 Replaying ..... 3-54  
 Return to default settings ..... 3-115  
 REVIEW ..... 3-22  
 Ring capture ..... 3-79  
 Ring capturing (internal RAM) ..... 3-75  
 Ring/Relay capture settings ..... 3-79  
 Room temperature compensation ..... 3-112  
 Rubber Protector of This Device ..... 1-5

**S**

Sampling interval (main sampling interval) ..... 3-70  
 Save/Read the current setting ..... 3-122  
 Scale upper/lower limit ..... 3-10  
 Scaling settings ..... 3-61, 3-67  
 Screen copy ..... 3-121  
 Screen display ..... 3-134  
 Screen Saver ..... 3-111



SD card . . . . . 3-6, 4-3  
SD CARD . . . . . 2-14  
SD card Remove/replace . . . . . 3-120  
Simple setting . . . . . 3-47  
Slope . . . . . 3-67  
Span . . . . . 3-31, 3-91  
SPAN mode. . . . . 3-39  
SPAN/TRACE/POSITION . . . . . 3-18  
Specified time setting . . . . . 3-102  
Standard Accessories . . . . . 4-10  
Standard Specifications . . . . . 4-2  
Start side source setting . . . . . 3-94  
START/STOP . . . . . 3-21  
Statistical calculation between cursors. . . . . 3-130  
Status mark . . . . . 3-6  
Status message . . . . . 3-5  
Stop side source setting . . . . . 3-95  
Synchronized Time . . . . . 3-110

**T**

TCP/IP advanced settings. . . . . 3-106  
Temperature settings . . . . . 3-112  
Temperature unit . . . . . 3-112  
Thumbnail display . . . . . 3-124  
Time/DIV . . . . . 3-30  
TIME/DIV . . . . . 3-19  
Time/DIV display . . . . . 3-5  
To Ensure Safe and Correct Use . . . . . i  
Trigger Functions . . . . . 4-8  
Trigger Input . . . . . 2-11  
Trigger level settings. . . . . 3-99  
TRIG settings . . . . . 3-93

**U**

USB Drive Mode . . . . . 3-21  
USB memory. . . . . 3-7  
USB memory Remove/replace . . . . . 3-120  
USB Memory slot . . . . . 4-3  
USB settings . . . . . 3-105

**V**

Vernier. . . . . 3-90  
VERNIER. . . . . 3-42  
Vernier reference line . . . . . 3-15

**W**

Warming-up Before Use . . . . . 1-3  
Waveform clear at the start of capturing. . . . . 3-91  
WEB Server. . . . . 3-132  
WEB server settings . . . . . 3-107  
When tilt foot is used. . . . . 2-4  
Window names . . . . . 3-2

**X**

X-axis level bar . . . . . 3-15  
XY display clear . . . . . 3-91  
XY display settings . . . . . 3-131  
XY Execution. . . . . 3-131  
XY monitor display . . . . . 3-43  
XY overwrite . . . . . 3-121, 3-131  
XY Overwrite . . . . . 3-92  
XY overwrite display . . . . . 3-50  
XY position . . . . . 3-41  
XY position reference line. . . . . 3-16  
XY screen monitor display . . . . . 3-14  
XY upper/lower scale . . . . . 3-16  
XY waveform display. . . . . 3-15, 3-39

**Y**

Y-axis level bar . . . . . 3-15  
Y-T waveform display . . . . . 3-10, 3-27

**Z**

Zero point . . . . . 3-91  
Zone division. . . . . 3-28



Specifications are subject to change without notice.

---

GL980 User's Manual

GL980-UM-151

October 5, 2017 1st edition-01

**GRAPHTEC CORPORATION**

---

**GRAPHTEC**