

GL860

midi LOGGER

USER'S MANUAL

MANUAL NO.GL860-UM-151

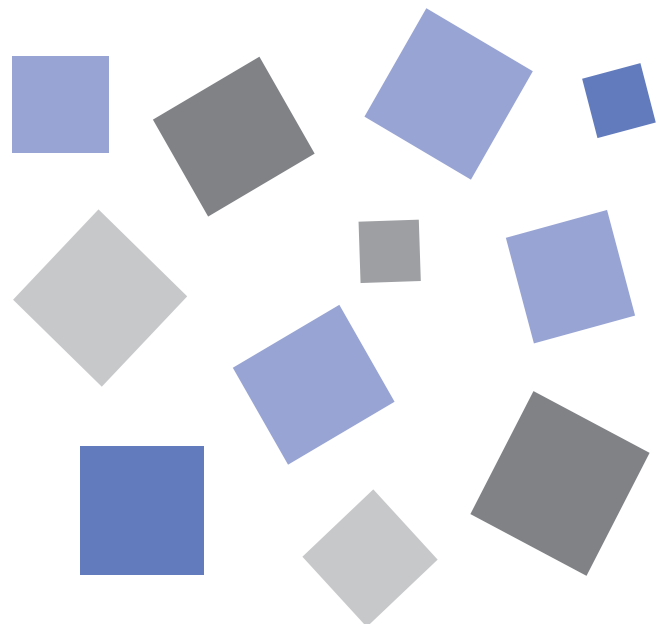





GRAPHTEC

To Ensure Safe and Correct Use









- To ensure safe and correct use of the GL860, read this manual thoroughly before use.
- After having read this manual, keep it in a handy location for quick reference as needed.
- Do not permit small children to touch the GL860.
- The following describes important points for safe operation. Please be sure to observe them strictly.

Conventions Used in This Manual

To promote safe and accurate use of the GL860 as well as to prevent human injury and property damage, safety precautions provided in this manual are ranked into the five categories described below. Be sure you understand the difference between each of the categories.

	DANGER	This category provides information that, if ignored, is highly likely to cause fatal or serious injury to the operator.
	WARNING	This category provides information that, if ignored, is likely to cause fatal or serious injury to the operator.
	CAUTION	This category provides information that, if ignored, could cause physical damage to the GL860.
	HIGH TEMPERATURE	This category provides information that, if ignored, is likely to cause burns or other injury to the operator due to contact with high temperature.
	ELECTRICAL SHOCK	This category provides information that, if ignored, is likely to expose the operator to electrical shock.

Description of Safety Symbols

	The  symbol indicates information that requires careful attention (including warnings). The specific point requiring attention is described by an illustration or text within or next to the  symbol.
	The  symbol indicates an action that is prohibited. Such prohibited action is described by an illustration or text within or next to the  symbol.
	The  symbol indicates an action that must be performed. Such imperative action is described by an illustration or text within or next to the  symbol.

Safety Precautions

WARNING

Be sure to securely connect the GL860's GND terminal.

- After checking that the power switch is turned off, connect the power cord's female plug to the GL860 and then connect its male plug into the electrical socket.
- For grounding, use a ground wire with a diameter of at least 0.75 mm². When using the GL860 in an environment where grounding is not possible, ensure measured is no greater than 50 V (DC or rms).

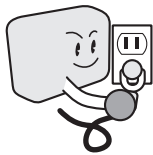

If the GL860 generates smoke, is too hot, emits a strange odor, or otherwise functions abnormally, turn off its power and unplug its power cord from the electrical socket.

- Use of the GL860 in such status may result in a fire hazard or electrical shock.
- After checking that smoke is no longer being generated, contact your sales representative or nearest Graphtec vendor to request repair.
- Never try to perform repair yourself. Repair work by inexperienced personnel is extremely dangerous.



Use prohibited

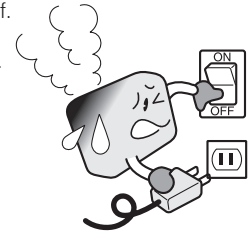

Before turning on the GL860, ensure that the electric socket's supply voltage conforms to the GL860's power rating.

- Use of a different supply voltage may cause damage to the GL860 or a fire hazard due to electrical shock or current leakage.



Use prohibited

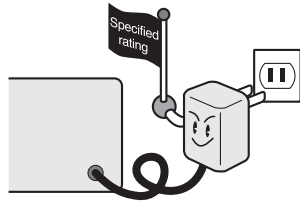

Never disassemble or remodel the GL860.

- Such action may cause a fire hazard due to electric shock or current leakage.
- Contact with a high-voltage component inside the GL860 may cause electric shock.
- If repair is required, contact your sales representative or nearest Graphtec vendor.



No disassembly



Avoid using the GL860 in extremely dusty or humid places.

- Such use may cause a fire hazard due to electrical shock or current leakage.



Use prohibited



Watch out for electrical shock

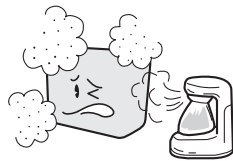

Avoid using the GL860 in places where it may be exposed to water such as bathrooms, locations exposed to wind and rain, and so on.

- An electrical shock or fire may be caused due to current leakage.



Avoid water



Watch out for electrical shock

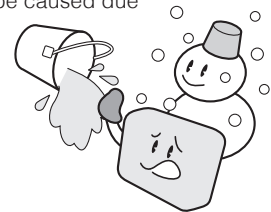

Prevent dust or metallic matter from adhering to the power supply connector.

- Adhesion of foreign matter may cause a fire hazard due to electrical shock or current leakage.



Use prohibited



Watch out for electrical shock

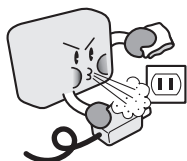

Never use a damaged power cord.

- Use of a damaged cord may result in a fire hazard due to electrical shock.
- If the cord becomes damaged, order a new one to replace it.



Unplug the power cord from the socket



Safety Precautions

⚠ CAUTION

Do not use or store the GL860 in a location exposed to direct sunlight or the direct draft of an air conditioner or heater.

- Such location may impair the GL860's performance.



Use prohibited

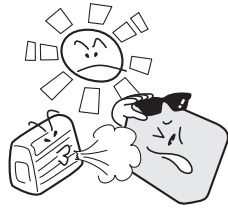

Do not place the receptacles containing fluid onto this device or close to this device.

- Fluid spilling inside the GL860 may cause a fire hazard due to electrical shock or current leakage.



Avoid water



Watch out for electrical shock



Do not use the GL860 in a location subject to excessive mechanical vibration or electrical noise.

- Such location may impair the GL860's performance.



Use prohibited

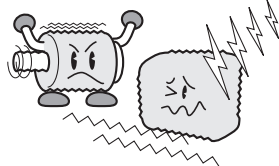

To insert or disconnect the power cord or a signal input cable, grasp the power cord's plug or the signal input cable's connector.

- Pulling the cord/cable itself damages the cord/cable, resulting in a fire hazard or electrical shock.



Use prohibited



If fluid or foreign matters enters inside the GL860, turn off the power switch and disconnect the power cord from the electrical socket.

- Use in such status may cause a fire hazard due to electrical shock or current leakage.
- Contact your sales representative or nearest Graphtec vendor to request repair.



Unplug the power cord from the socket

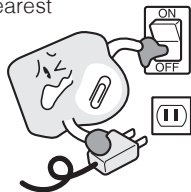

Do not use the AC power supply and the DC power supply other than the specified supply voltage for this device.

- Such action may cause a fire hazard due to electric shock or current leakage.



Use prohibited

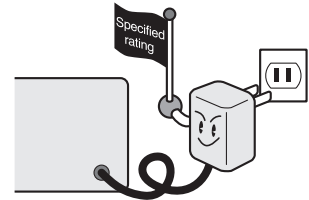

Do not attempt to lubricate the GL860's mechanisms.

- Such action may cause the GL860 to break down.



Use prohibited

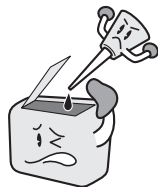

Never clean the GL860 using a volatile solvent (such as thinner or benzene).

- Such action may impair the GL860's performance.
- Clean off any soiled areas using a soft dry cloth.



Use prohibited

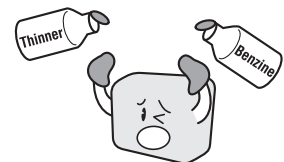

Be sure to use the Graphtec-supplied AC adapter.

- It will damage this device.



Use prohibited

Safety Precautions

CAUTION

Do not touch the input terminals after the signal cable is connected to the measuring objects that are containing the voltage.

- It will cause the electric shock.
- Ensure that the GL860's power source is positioned so that it can easily be disconnected.



Strict observance



Watch out for electrical shock

Confirm the power of supplier of signal is turned off before connecting the input cables to the input terminal of this device to prevent the electric shock.

- It will cause the electric shock.



Strict observance



Watch out for electrical shock

Do not touch the device with wet hands.

- This can cause an electrical shock or malfunction.



Don't touch with wet hands

Be careful of static electricity.

- Static electricity may damage the device. To prevent this from happening, touch a different metal object to discharge any built-up static electricity before touching the GL860.



CAUTION

Do not input the voltage that is exceeding the specification of this device.

- If a voltage exceeding the specified value is input, the semiconductor relay in the input section will be damaged. Never input a voltage exceeding the specified value even for a moment.



Strict observance

- Have an enough margin from the specification of withstanding voltage when using this device, it have to consider a noise and change of the measurement voltage.



CAUTION

- It will cause the fire or the electric shock when the voltage is input to the defective device.



Use prohibited

Do not block the air vent on the GL860.

- This device will get damage when there is abnormal heat in this device.



Strict observance



HIGH TEMPERATURE

Confirm this device is not broken before the input cable is connected to the input terminal.

- It will cause the fire or the electric shock when the voltage is input to the defective device.



Use prohibited

Safety Precautions



When using the wireless LAN unit (optional), please note the following:

- If you have an implantable pacemaker or implantable defibrillator installed, radio signals from the device may have an effect on the operation of your implantable pacemaker or implantable defibrillator.
- If you have an implantable pacemaker or implantable defibrillator, the radio signals from the device may have an effect on the operation of your implantable pacemaker or implantable defibrillator.



Strict observance

When using the wireless LAN unit (optional) in a medical establishment, please note the following rules:

- Please turn off the power of this product in hospital wards.
- Each medical institution has its own usage prohibitions in various areas. Be sure to follow these.



Strict observance

When using the wireless LAN unit (optional), please note the following:

- Turn off the device in places where wireless radio signal use is restricted, such as on aircrafts and in hospitals. The device can have an effect on electronic devices, medical devices, etc., and may cause malfunctions.



Use prohibited

When using the wireless LAN unit (optional), please note the following:

- In the event that the device has an effect on automatic electronic devices such as cars or elevators, immediately turn off the GL860.



Use prohibited

Do not use the device in any way not specified in this manual. There is a danger that protective provisions will have not been put in place.



Use prohibited

The module connection terminal is for use only with separately sold sensors and modules. Do not connect any other devices. Doing so may damage the GL860.



Use prohibited

This GL860 is not meant for use with lifesaving devices or devices with mission-critical high reliability or high safety requirements (medical devices, aerospace devices, shipping devices, nuclear power devices, etc.). In the event that this GL860 causes injury or property damage when used under these circumstances, the maker assumes absolutely no responsibility and is not liable.

Introduction

Thank you for purchasing the GL860 midi LOGGER.

Please read this manual thoroughly before attempting to use your new product to ensure that you use it correctly and to its full potential.

Notes on Use

Be sure to read all of the following notes before attempting to use the GL860 midi LOGGER.

1. Note on the CE Marking

The GL860 midi LOGGER complies with the following standards.

- EN 61326-1 standard is based on the EMC Directive
- EN 61010-1 standard is based on the Low Voltage Directive (LVD)
- EN 301 489-17/-1, EN 300 328 standards are based on the Radio Equipment Directive (RED)
(Use optional B-568)

Although the GL860 complies with the above-mentioned standards, be sure to use it correctly in accordance with the instructions and notes provided in this manual.

Moreover, the use of the GL860 by incorrect procedures may result in damage to the GL860 or may invalidate its safeguards.

Please confirm all of its notes regarding use and other related information to ensure correct use.

CE Information of Regulation (EU) 2023/1542

The manufacturer information of the Lithium Rechargeable Battery mounted on the internal board of the data logger is as below.

Manufacturer:

Name: Seiko Instruments Inc.

Address: 8, Nakase 1-chome, Mihama-ku, Chiba-shi, Chiba 261-8507, Japan

2. Warning

This is a Class A product according to the EMC directive. In a domestic environment, this product may cause radio interference or may be affected by radio interference to the extent that proper measurement cannot be performed.

3. Notes on Radio Law

When using the GL860 midi LOGGER in the wireless LAN unit (optional), please note the following:

- (1) Do not remove the technical standards compliance label. Do not use the device if it does not have a label on it.
- (2) This GL860 uses the 2.4GHz frequency band.
The following devices and transmitters use the same frequencies and should not be used near this GL860:
 - Microwave ovens
 - Pacemakers and other industrial, science, and medical devices
 - Radio transmitters used in mobile body identification devices on factory production lines, etc. (transmitters requiring licensing)
 - Interference with radio waves from specified low-power radio stations (radio transmitters not requiring licensing), Bluetooth, etc. may slow down the communication speed or prevent communication.
- (3) The signal may be weak or communications may become slower or impossible depending on the circumstances in which GL860 is used. Take particular note of steel-reinforced, metal, concrete, and other structural materials that can inhibit radio waves.

- This GL860 is meant for use in Japan, the US, Europe, Taiwan, China and Korea. It has not been certified for use under any other country's radio laws.

The following are each region's certification marks.

Japan

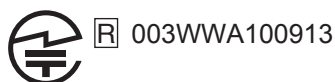

Taiwan



US

Contains FCC ID: ANSBP3591

China

CMIIT ID: 2015DJ5376

Europe

CE Mark

Korea

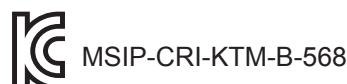

This device complies with part 15 of the FCC Rules. Operation is subject to the following two conditions:

- (1) This device may not cause harmful interference, and (2) this device must accept any interference received, including interference that may cause undesired operation.

FCC CAUTION

Change or modifications not expressly approved by the party responsible for compliance could void the user's authority to operate the equipment.

This transmitter must not be co-located or operated in conjunction with any other antenna or transmitter.

4. Notes for Safe Operation

- (1) Be sure to use the Graphtec-supplied AC adapter. In environments where there is a lot of noise or where the power supply is unstable, we recommend that you ground the GL860.
- (2) When a high-voltage signal cable has been connected to the main unit's analog signal input terminal, avoid touching the leads of the input terminal's signal cable to prevent electrical shock due to high voltage.
- (3) Ensure that the GL860's power source is positioned so that it can easily be disconnected.
- (4) Do not input the voltage that is exceeding the specification of this device.
 - If a voltage exceeding the specified value is input, the semiconductor relay in the input section will be damaged. Never input a voltage exceeding the specified value even for a moment. It will cause a fire.
 - Have enough margin from the specification of withstanding voltage when using this device, it has to consider noise and change of the measurement voltage.
 - Confirm this device is not broken before the input cable is connected to the input terminal.
 - Please take care of the static electricity when connecting the input cables or the thermocouples.
 - Do not touch the tip of the thermocouples with a bare hand after the thermocouples are connected to the terminal of this device when the tip of the thermocouples is not insulated. The static electricity of the human body will cause damage to this device.
 - Do not put the tip of the thermocouples on the object which is containing the static electricity when the tip of the thermocouples is not insulated. The static electricity of an object will cause damage to this device.
 - Do not put the tip of the thermocouples to the object which is containing the leaked high voltage of chassis or metal etc. when the tip of the thermocouples is not insulated. The leaked high voltage of the object will cause damage to this device.
 - We recommend that the insulation tape be put on the tip of the thermocouples before connecting the thermocouples to the input terminals. This will protect this device from the static electricity and the leaked high voltage.

* All CHs are applicable even when CHs are extended.

* When B-563 (B-563SL, B-563SL-30) and B-565 are mixed, all CHs are subject to B-563 (B-563SL, B-563SL-30) specifications.

5. Notes on Functions and Performance

- (1) Be sure to connect the main unit to an AC or DC power supply that conforms to the rated range. Connection to a non-rated power supply may cause the main unit to overheat and break down.
- (2) Do not block the vent on the main unit. Continued operation with the vent blocked may cause the main unit to overheat and break down.
- (3) To avoid malfunctions and other damage, avoid using the GL860 in the following locations.
 - Places exposed to high temperature and/or high humidity, such as in direct sunlight or near heating equipment.
(Allowable temperature range: 0 to 45°C (0 to 40°C when a battery pack is mounted, 15 to 35°C when battery is being charged), Allowable humidity range: 5 to 85%R.H., non-condensing)
 - Locations subject to excessive salt spray or heavy fumes from corrosive gas or solvents.
 - Excessively dusty locations.
 - Locations subject to strong vibrations or shock.
 - Locations subject to surge voltages and/or electromagnetic interference.
- (4) If the main unit becomes soiled, wipe it off using a soft, dry cloth. The use of organic solvents (such as thinner or benzene) causes deterioration and discoloration of the outer casing.
- (5) Do not use the GL860 in the vicinity of other devices which are susceptible to electromagnetic interference.
- (6) Measured results may not conform to the stated specifications if the GL860 is used in an environment that is subject to strong electromagnetic interference.
- (7) Insofar as possible, position the GL860 input signal cables away from any other cables that are likely to be affected by electromagnetic interference.
- (8) For stabilized measurement, allow the GL860 to warm up for at least 30 minutes after turning it on.

Notes on the Use of This Manual

- (1) All rights reserved. No part of this publication may be reproduced, stored in a retrieval system, or transmitted, in any form or by any means, without the prior written permission of Graphtec Corporation.
- (2) The specifications and other information in this manual are subject to change without notice.
- (3) While every effort has been made to supply complete and accurate information about this product, please address any inquiries about unclear information, possible errors, or other comments to your sales representative or nearest Graphtec vendor.
- (4) Notwithstanding the preceding paragraph, Graphtec Corporation assumes no liability for damages resulting from the use of the information contained herein or of the product.

About Registered Trademarks

Microsoft and Windows are registered trademarks or trademarks of Microsoft Corporation in the U.S. and elsewhere. Other company names and product names included in this manual are registered trademarks or trademarks of their respective companies.

Copyright

All copyrights regarding this manual belong to Graphtec Corporation.

Contents

To Ensure Safe and Correct Use	i
Safety Precautions	ii
Introduction	I
Notes on Use	I
Notes on the Use of This Manual	III
About Registered Trademarks	III
Copyright	III

Chapter 1 General Description

1.1 Overview	1-2
1.2 Features	1-2
1.3 Supported Input Terminals	1-3
1.4 Operating Environment	1-4
Ambient Operating Conditions	1-4
Warming-up Before Use	1-4
Configuration When in Use	1-5
1.5 Notes on Temperature Measurement	1-5
1.6 Notes on Using the Monitor	1-6
1.7 Changing the Display Language	1-6
1.8 Power frequency settings	1-6
1.9 Custom Menu Settings	1-7

Chapter 2 Checks and Preparation

2.1 Checking the Outer Casing	2-2
2.2 Checking the Accessories	2-2
2.3 Mounting and removing each terminal	2-3
2.4 Mounting the Extension Terminal Base (Optional) and Extension Terminal Cable (Optional)	2-5
2.5 Nomenclature and Functions	2-11
2.6 Connecting the Power Cable and Turning on the Power	2-12
2.7 Connecting the Signal Input Cables	2-14
2.8 Logic Alarm Cable Connection and Functions	2-19
2.9 Mounting the SD Memory Card	2-22
2.10 Installing the Wireless LAN Unit (B-568: Option)	2-24
2.11 Connecting to a PC	2-26
2.12 Using the Battery Pack (B-573/B-569: Option)	2-29
2.13 Connecting the Humidity Sensor	2-31
2.14 Precautions to Observe When Performing Measurement	2-32
2.15 Noise Countermeasures	2-35
2.16 When Fixing the GL860 Main Unit	2-36
2.17 Setting the Date and Time	2-37

Chapter 3 Settings and Measurement

3.1	Name of each screen part and functions	3-2
3.2	Key Operations	3-9
3.3	Operation Modes	3-19
3.4	Setting Menus	3-23
	1. AMP settings	3-23
	2. DATA settings	3-41
	3. TRIG settings	3-50
	4. ALARM settings	3-52
	5. Interface settings	3-65
	6. OTHER settings	3-81
	7. Span/Position/Trace settings	3-90
	8. FILE menu	3-93
	9. File dialog	3-99
	10. Text input	3-100
	11. Data replay menu	3-103
	12. Quick setting	3-107
	13. To cancel key lock by password	3-108
	14. QR code	3-109
3.5	WEB Server Function	3-110
3.6	List of Error Codes	3-114

Chapter 4 Example of Use

4.1	Capturing procedure	4-2
	1. Preparation	4-2
	2. Settings	4-3
	3. Capturing	4-10
4.2	Replay procedure	4-12
	1. Replay procedure	4-12
	2. Replay screen	4-15
	3. Finish replaying	4-16
4.3	Other functions	4-17
	1. Custom function	4-17
	2. Trigger function	4-17
	3. Automatic span adjustment (auto span) function	4-17
	4. Remote control service cooperation function	4-18
	5. Data corruption check function	4-18
	6. USB drive mode	4-18
	7. Inter-CH operation function	4-19
	8. Alarm history	4-19
	9. Memory loop function	4-19
	10. FUNC function	4-20
	11. CH copy function	4-20

Chapter 5 Specification

5.1	Standard Specifications	5-2
	Standard Specifications	5-2
	Memory devices	5-3
	PC I/F	5-3
	Monitor	5-3
	B-563/B-563SL Specifications	5-4
	B-563SL-30 Specifications	5-6
	B-565 Specifications	5-8
5.2	Function Specifications	5-10
	Function Specifications	5-10
	Trigger/Alarm Functions	5-10
	External Input/Output Functions	5-11
5.3	Accessories/Optional Accessories	5-12
	Control Software	5-12
	Accessories	5-12
	Wireless Unit B-568 (Option)	5-12
	Battery Pack B-573 (Option)	5-13
	Humidity Sensor B-530 (Option)	5-13
	List of Options	5-14
5.4	External Dimensions	5-15

Chapter 1 General Description

This chapter provides a general description of the GL860 and its features.

SECTION IN THIS CHAPTER

- 1.1 *Overview*
- 1.2 *Features*
- 1.3 *Supported Input Terminals*
- 1.4 *Operating Environment*
- 1.5 *Notes on Temperature Measurement*
- 1.6 *Notes on Using the Monitor*
- 1.7 *Changing the Display Language*
- 1.8 *Power frequency settings*
- 1.9 *Custom Menu Settings*

1.1 Overview

The GL860 is a compact, lightweight, multi-CH, and multi-purpose data logger with a 7-inch color display. There are three types of terminal units with 20 channels.

By using the expansion terminal base, it is possible to measure up to 200 channels.

The GL860 can save the high-capacity measurement data directly in the internal memory or SD CARD.

For the PC interface, as USB and Ethernet are included as standard, system configuration according to use is possible. As the Ethernet function is equipped with both WEB server and FTP server functions, remote supervision and data transfer are also possible.

1.2 Features

Input

- Adoption of a pluggable M3 screw type or screwless type input terminal facilitates wiring.
- Up to 200 channels can be connected using the expansion terminal base and the terminal unit with 20 channels and 30 channels.
- Because the terminals of all terminal units have a whole CH isolated, the different standard signals can be measured at the same time.
In addition, when using the withstand high-voltage high-precision terminal, you can measure the environmental conditions of high withstand voltage.

Display

- With the GL860's high-resolution 7-inch TFT color liquid crystal display, you can confirm the waveforms of measured data and each channel's settings at a glance.
- Easy operation is achieved through a straightforward menu structure and key allocation which resembles mobile phones.

Data Capture

- The high-capacity measurement data can be saved directly in the internal memory or SD memory card.
- Because the SD memory card is used as an external memory, you can measure a long period of time with peace of mind while data backup.
* When the optional wireless LAN unit is installed, the SD memory card cannot be inserted into the SD CARD slot.
- Because disk images can be used for the internal memory, multiple data can be saved.
- The new ring memory capture function maintains the latest data even after capturing for a long term. (You need to set how long you want to keep data.)
- For voltage, temperature and humidity measurements, data can be captured at sampling rates of up to 5 ms per channel by using fewer measuring channels. (Temperature measurement can be done at sampling rates of 100 ms and higher.)
- The GL860 is equipped with the relay recording function, and 2000MByte or more data can be saved by switching to the other file without data missing. (When the capacity of one file reaches 2000MByte, the file is switched.)

Data Control & Processing

- The application software provided lets you set conditions and monitor data on a PC.
- The USB drive mode function enables the internal memory and SD CARD to be recognized as an external drive by the PC.
(After connecting the GL860 to the computer, turn on the power of the GL860 while holding down the [START] key.)
- The WEB server function enables control and monitoring from a remote location without using dedicated software
- The FTP client function enables backup of measurement data to the FTP server.
- The NTP client function enables synchronization of the time with the NTP server.

1.3 Supported Input Terminals

This section describes the input terminals supported by this unit.

① Standard 20CH screw terminal
(B-563)

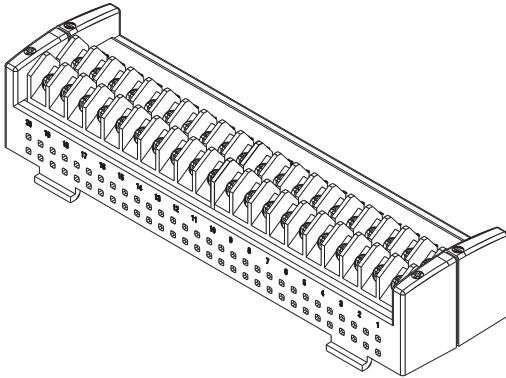

② Standard 20CH screwless terminal
(B-563SL)

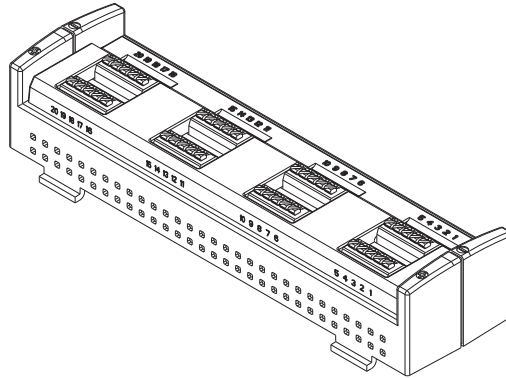

③ Standard 30CH screwless terminal
(B-563SL-30)

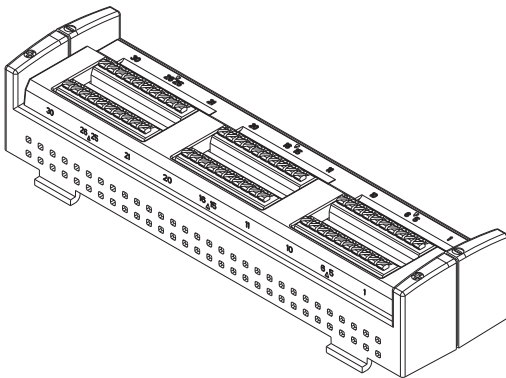

④ Withstand high-voltage high-precision terminal
(B-565)

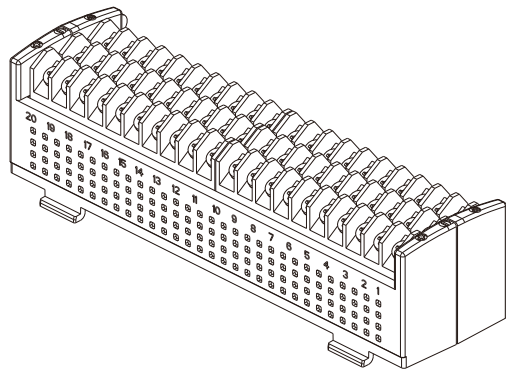

⑤ 20CH screw terminal for GL840/GLT400
(B-564)

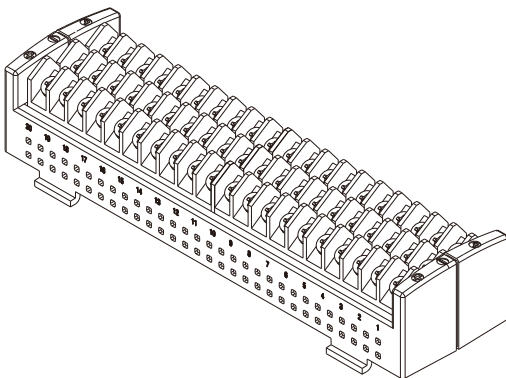

⑥ 20CH screwless terminal for GL840/GLT400
(B-564SL)

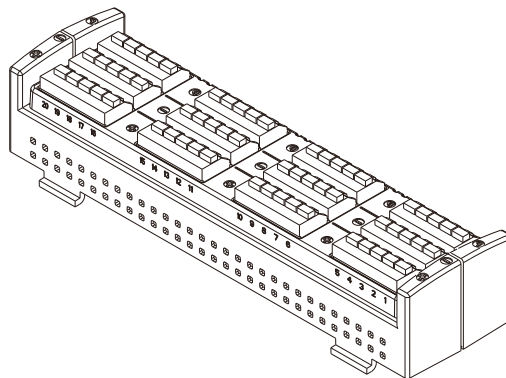

The terminal blocks for GL840 and GLT400 (⑤ to ⑥) can also be used with the GL860.

1.4 Operating Environment

This section explains the operating environment for the GL860.

Ambient Operating Conditions

- (1) Ambient temperature and humidity (the GL860 must be operated within the following ranges.)
 - Temperature range: 0 to 45°C (0 to 40°C when a battery pack is mounted, 15 to 35°C when battery is being charged)
 - Humidity range: 5 to 85%R.H.
- (2) Environment (do not use in the following locations.)
 - Outdoor
 - A Location such as being exposed to direct sunlight
 - Locations exposed to salty air, corrosive gases, or organic solvents
 - Dusty locations
 - Locations subject to vibration or impact
 - Locations subject to voltage surge or electromagnetic interference such as lightning or electric furnaces
- (3) Installation category (over-voltage category)
 - The GL860 belongs to Installation Category II defined in IEC60664-1.
 - Never use the GL860 for Installation Category III or IV.
- (4) Measurement category
 - The Standard 20CH screw terminal (B-563), Standard 20CH screwless terminal (B-563SL) and Standard 30CH screwless terminal (B-563SL-30) connected to the GL860 should be not used in Measurement Category II, III, and IV.
 - The withstand high-voltage high-precision terminal (B-565) connected to belongs to Category II.
- (5) Altitude
 - Altitude up to 2000 m.
- (6) Mains supply voltage
 - 100 to 240 VAC \pm 10%
- (7) Pollution degree
 - POLLUTION DEGREE 2 in accordance with IEC60664

Checkpoint

- If condensation occurs...
Condensation occurs in the form of water droplets on the device surfaces and interior when the GL860 is moved from a cold to a warm location. Using the GL860 with condensation will cause malfunctioning.
Wait until the condensation has disappeared before turning on the power.

Warming-up Before Use

The GL860 should be allowed to warm up with the power turned on for approximately 30 minutes to ensure that it operates according to the specified performance.

Configuration When in Use

Do not use the GL860 standing upright or at an angle. It must always be laid flat or inclined on the stands.

<Usage Configuration>

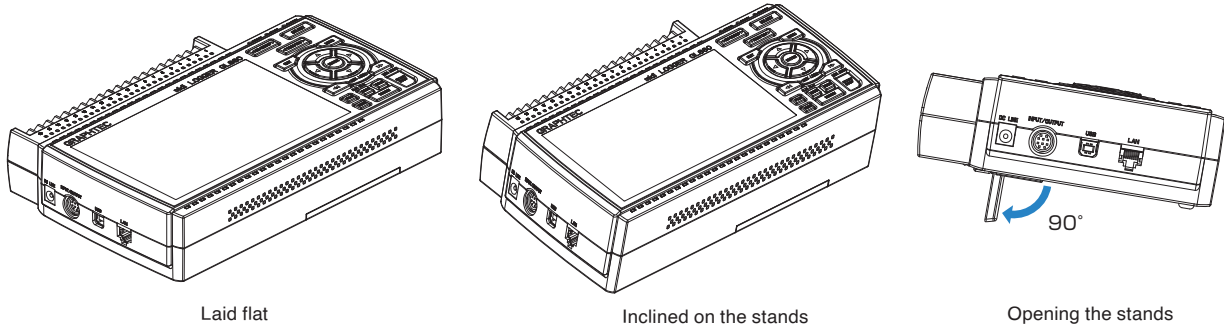

CAUTION

- Do not block the air vent on the GL860, as this will cause malfunctioning.
- Measurement accuracy may not be satisfactory if the system is used in a condition other than described above.
- To prevent possible toppling, use both of the stands of the GL860 when you place it inclined.
- Use the GL860 with both of the two stands open as shown in the figure above.

1.5 Notes on Temperature Measurement

Please observe the following precautions when performing temperature measurements.

- Do not block the air vents. Always provide a space of at least 30 cm on all sides of the GL860.
- For stabilized temperature measurement, allow the GL860 to warm up for at least 30 minutes after turning it on.
- Exposure of the input terminals to direct drafts, direct sunlight, or abrupt changes in temperature may impair the equilibrium of the input parts and result in measurement errors. To measure temperature in such an environment, take appropriate countermeasures such as changing the installation site of the GL860.
- To conduct measurements in noisy environments, connect the GL860's GND terminal to the ground. (Refer to "2.15 Noise Countermeasures".)
- If measured values fluctuate due to noise, set to a slower sampling speed. (Refer to "2. DATA setting" in "3.4 Setting Menus".)

1.6 Notes on Using the Monitor

The monitor is an LCD display unit, so the display will vary depending on the operating environment.

Checkpoint

If the screen saver function is used, it will operate and clear the screen if no operations are performed during the preset time. If the screen saver operates, press any key to restore the display.

CAUTION

- Condensation may form on the LCD screen if the GL860 is moved from a cold to a warm location. If this occurs, wait until the LCD screen warms up to room temperature.
- The LCD screen is manufactured to extremely high precision. Black dots may appear, or red, blue, and green dots may not disappear. Likewise, streaks may appear when viewed from certain angles. These phenomena are due to the LCD screen construction, and are not signs of a fault.

1.7 Changing the Display Language

You can choose the language displayed on the screen. The default display language is set to English (US) when the GL860 is shipped overseas. To change the display language, set the language in "Initial settings: Language" that is displayed at the first startup or "Other menu: System settings: Language".

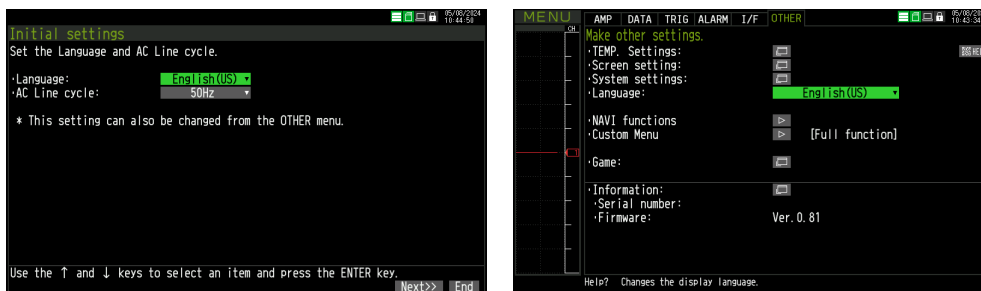

1.8 Power frequency settings

The GL860 allows you to select the power supply frequency.

The power frequency must be set according to the environment in which it will be used.

The power frequency is set to 50 Hz when shipped from Japan and 60 Hz when shipped from overseas.

To change the power supply frequency, set "Initial Settings: AC Line cycle" displayed at the first startup or "OTHER menu" - "System Settings: AC Line cycle".



1.9 Custom Menu Settings

The GL860 allows you to customize the menus that are displayed.

By turning off functions that are not used, they will not appear in the settings menu, etc.

To change this setting, set “Custom Menu” which is displayed when the GL860 is first started, or “Custom Menu” in the “OTHER Menu”.



Chapter 2 Checks and Preparation

This chapter explains how to check the main module's external casing and accessories, and how to prepare the main module for operation.

SECTION IN THIS CHAPTER

- 2.1 *Checking the Outer Casing*
- 2.2 *Checking the Accessories*
- 2.3 *Mounting and removing each terminal*
- 2.4 *Mounting the Extension Terminal Base (Optional) and Extension Terminal Cable (Optional)*
- 2.5 *Nomenclature and Functions*
- 2.6 *Connecting the Power Cable and Turning on the Power*
- 2.7 *Connecting the Signal Input Cables*
- 2.8 *Logic Alarm Cable Connection and Functions*
- 2.9 *Mounting the SD Memory Card*
- 2.10 *Installing the Wireless LAN Unit (B-568: Option)*
- 2.11 *Connecting to a PC*
- 2.12 *Using the Battery Pack (B-573/B-569: Option)*
- 2.13 *Connecting the Humidity Sensor*
- 2.14 *Precautions to Observe When Performing Measurement*
- 2.15 *Noise Countermeasures*
- 2.16 *When Fixing the GL860 Main Unit*
- 2.17 *Setting the Date and Time*

2.1 Checking the Outer Casing

After unpacking, check the GL860's outer casing before use. In particular, please check for the following:

- Surface scratches
- Other flaws such as stains or dirt

2.2 Checking the Accessories

After unpacking, check that the following standard accessories are included.

Standard Accessories

Item	Remarks	Quantity
Quick Start Guide	GL860-UM-80x	1
AC cable/AC adapter *1	100 to 240 VAC, 50/60 Hz	1

*1 Specifications vary depending on destination.

2.3 Mounting and removing each terminal

This section describes the mounting and removing procedure of the Standard 20CH screw terminal.

The Standard 20CH screwless terminal, Standard 30CH screwless terminal and Withstand high-voltage high-precision terminal can be removed and attached in the same way.

⚠ CAUTION

When mounting or removing the standard terminal or Withstand high-voltage high-precision terminal, please make sure that the GL860's power is turned OFF.

Mounting

Insert the lock tabs at the top of the standard terminal or the Withstand high-voltage high-precision terminal into the slots of the GL860, and push in the terminal until the lock tabs at the bottom of the terminal are securely locked.

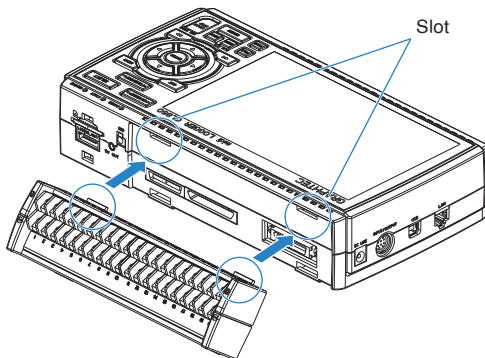

1. Insert tabs at the top of the terminal unit into the slots.

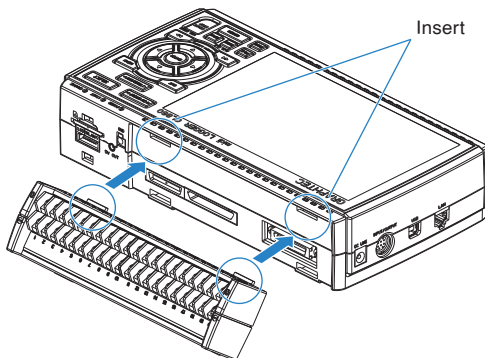

2. Press the terminal unit in the direction shown until it is securely locked.

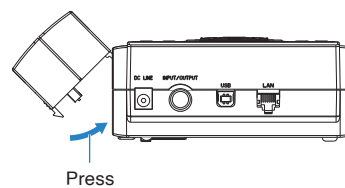
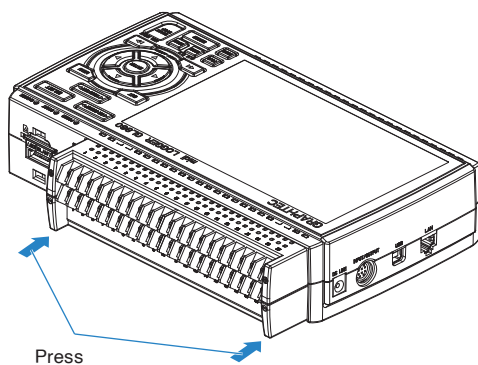

CAUTION

The specifications of the Standard 20CH screw terminal (or Standard 20CH/30CH screwless terminal) and the Withstand high-voltage high-precision terminal are different, so please check the specifications before use.

Removing

Pull out the terminal in the direction of the arrow while pressing the lock portion (place) under the Standard 20CH screw terminal.

1. Press the two lock portions in the direction indicated by arrows.

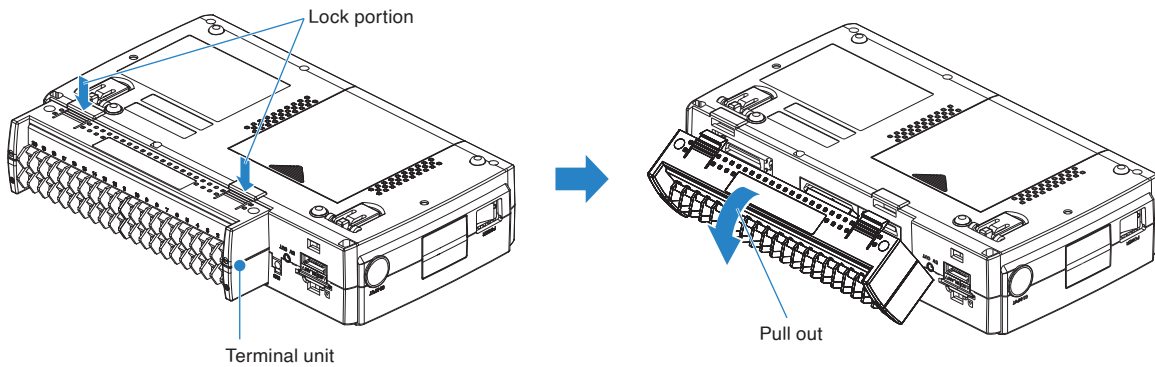

2. Pull the terminal unit out towards the direction indicated by the arrow.

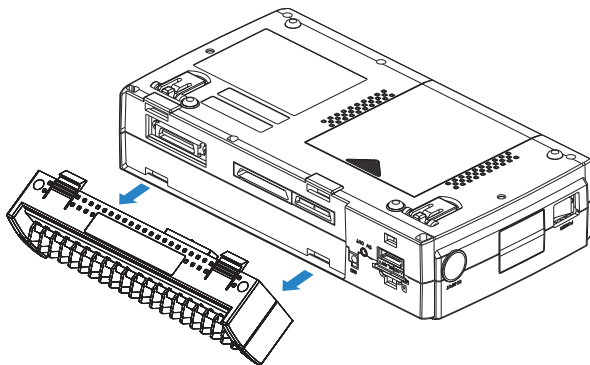

Pull the terminal unit out as shown in the following figure.

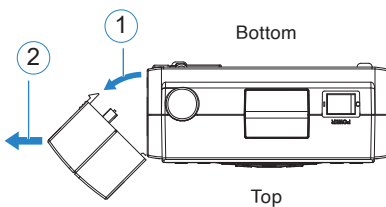

2.4 Mounting the Extension Terminal Base (Optional) and Extension Terminal Cable (Optional)

2.4.1 Mounting the extension terminal base

This section describes how to mount the extension terminal base.

CAUTION

When mounting the extension terminal base on the GL860, please make sure that the GL860's power is turned OFF.

Prepare the extension terminal base and the extension terminal connection cable which are sold as optional items.

B-566 Extension Terminal Base

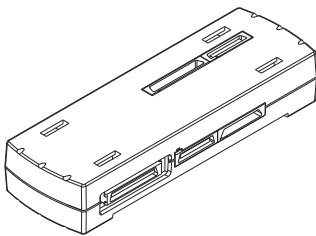

Extension terminal base: 1 unit

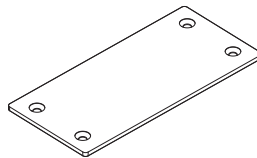

Connection plate: 1 pc.



M4 x 6 flat-head screw: 4 pcs.

B-567 Extension terminal connection cable (Select from two types of cables)

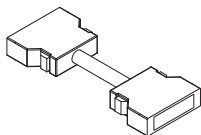

Extension terminal connection cable
(50 cm: B-567-05): 1 pc.

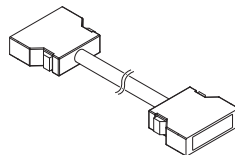

Extension terminal connection cable
(2 m: B-567-20): 1 pc.

Mounting

1. Remove the Standard terminal or the Withstand high-voltage high-precision terminal mounted on the GL860.
2. Insert the lock tabs at the top of the terminal into the slots of the extension terminal base, and press the terminal until the lock tabs at the bottom of the terminal are securely locked.

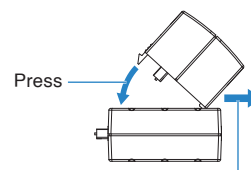
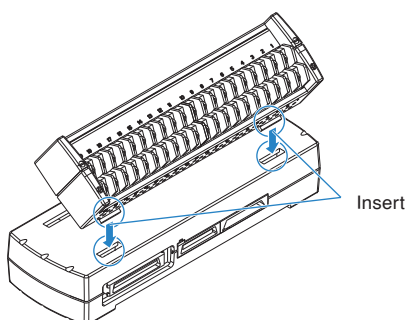

* When installing the Withstand high-precision terminal (B-565), please push it while pulling to the front.

3. Connect the extension terminal connection cable to the extension terminal base.
 - * Insert the extension terminal connection cable until the cable is securely locked.
 - * Connect in accordance with the connector shape.

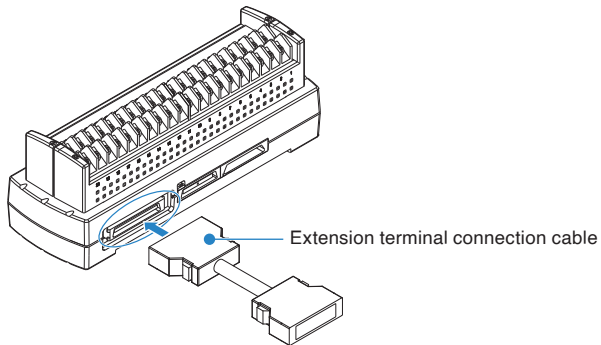

4. Connect one end of the extension terminal connection cable to the terminal connector on the GL860.
 - * Insert the extension terminal connection cable until the cable is securely locked.

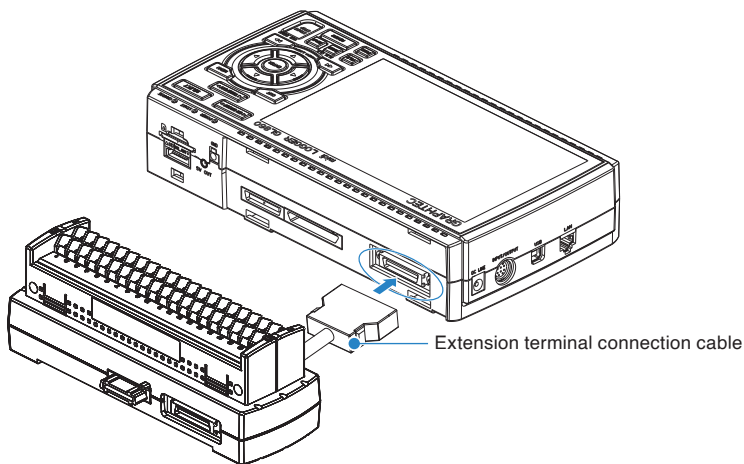

Checkpoint

When one terminal unit (20ch/30ch) is mounted, the connecting plate and flat-head screw are not used.

CAUTION

- How to remove the expansion terminal connection cable

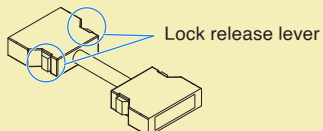

When you want to remove the terminal connection cable from the GL860 or extension terminal base, please note the following.

- Always press the both sides of the lock release lever and pull out straightly in a state where the lock is released.
- Please do not forcibly remove or do not pull out in a state where the lock is not released by pressing only the one side of the lock release lever.

It may cause a connection failure of connector, please be careful when you remove it.

2.4.2 Mounting multiple extension terminals

The mounting procedure of the multiple extension terminal set is described.

CAUTION

Mounting multiple extension terminals make sure the GL860's power is OFF when mounting the extension terminals on the GL860.

Prepare the sold separately extension terminal base and extension terminal connection cable.

B-566 Extension terminal base

Prepare the number of extension terminal bases that are equal to the number that the standard terminal or the Withstand high-voltage high-precision terminal is added.

B-567 Extension terminal connection cable (Select from two types of cables)

Prepare one of the two types of extension terminal connection cables (50 cm: B-567-05 or 2 m: B-567-20).

Also, when you want to connect away between the extension terminal bases, the required number of the extension terminal bases must be prepared.

When direct-connecting the extension terminal bases

1. Connect the extension terminal base unit connectors as shown below.

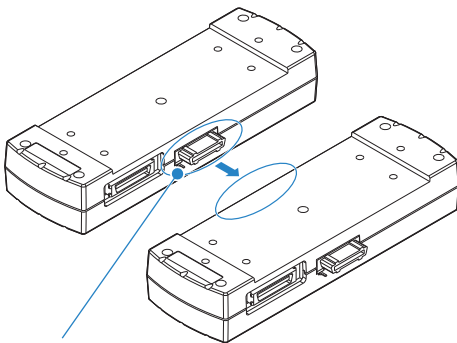

* Please direct-connect to the protruding parts carefully.

CAUTION

- Please direct-connect the extension terminal bases carefully so as not to bend the protruding parts next to the connector.
- Please handle the connection plate in a horizontal state until the connection plate is fixed.

2. Fix the connection plate using attached screws.

* Recommended screw torque: 14 kgf/cm

M4 x 6 flat head screws

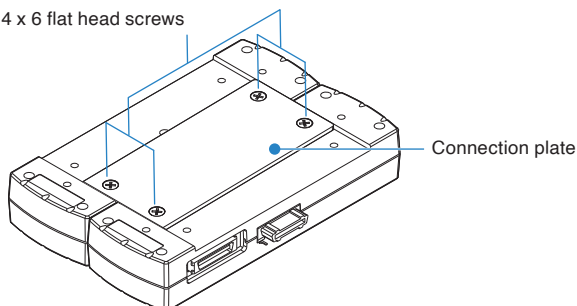

3. Connect the extension terminal connection cable to the extension terminal base.

- * Insert the cable connector until it is securely locked.
- * Connect in accordance with the connector shape.

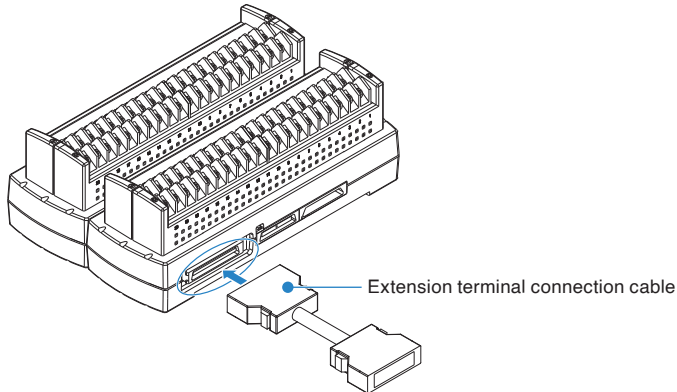

4. Connect one end of the extension terminal connection cable to the GL860.

- * Insert the cable connector until it is securely locked.

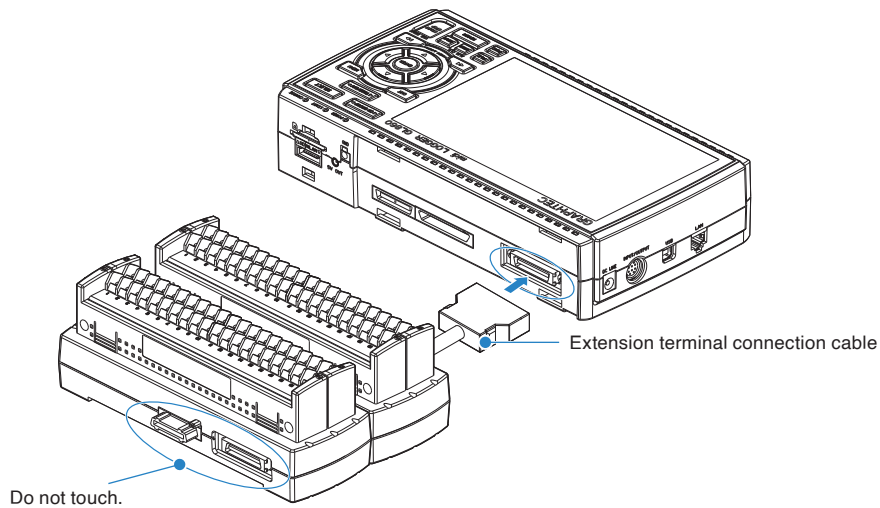

CAUTION

While the signal is input to the direct-connected terminal, please do not touch the connector pins and the protruding part next to the connector.

CAUTION

- How to remove the expansion terminal connection cable

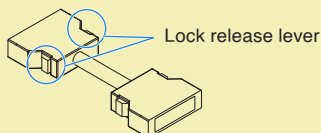

When you want to remove the expansion terminal connection cable from the GL860 or extension terminal base, please note the following.

- Always press the both sides of the lock release lever and pull out straightly in a state where the lock is released.
- Please do not forcibly remove or do not pull out in a state where the lock is not released by pressing only the one side of the lock release lever.

It may cause a connection failure of connector, please be careful when you remove it.

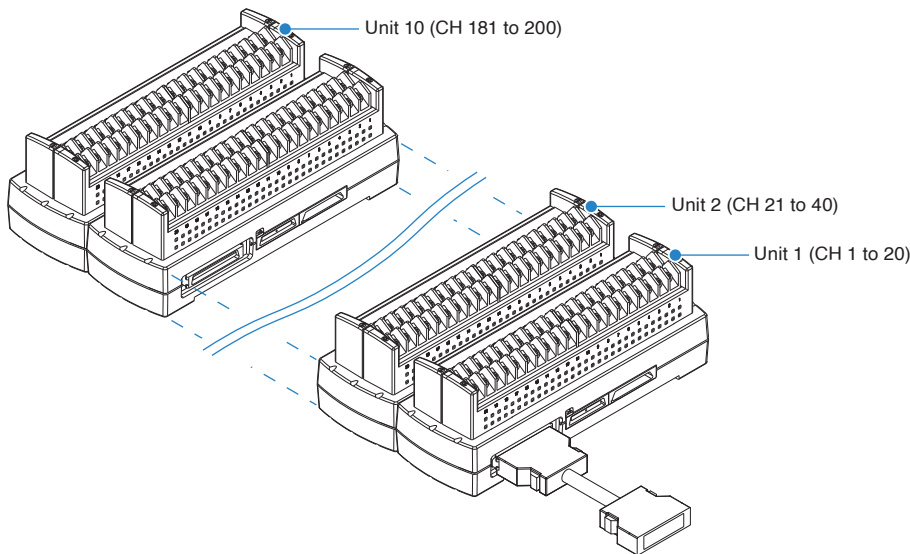
When adding the extension terminal bases**CAUTION**

- When the terminals are added, please connect continuously them without disconnecting terminals. If there is a disconnected terminal, subsequent terminals are not recognized.
- When the combination of the Standard 20CH screw terminal and Withstand high-voltage high-precision terminal is used, the withstand voltage specification of the standard terminal is applied.
- When using a Standard 30CH screwless terminal in combination, terminals connected across 200CH will not be recognized.
Example: When 190CH is implemented with eight Standard 20CH screwless terminals and one Standard 30CH screwless terminal, even if an additional Standard 20CH screwless terminal is installed, the total will be 210CH, so the additional terminal will not be recognized.

When direct-connecting with an extension terminal connection cable

1. Connect between the extension terminal bases with the extension terminal connection cable.
 - * Insert the extension terminal connection cable until the cable is securely locked.
 - * Connect in accordance with the connector shape.

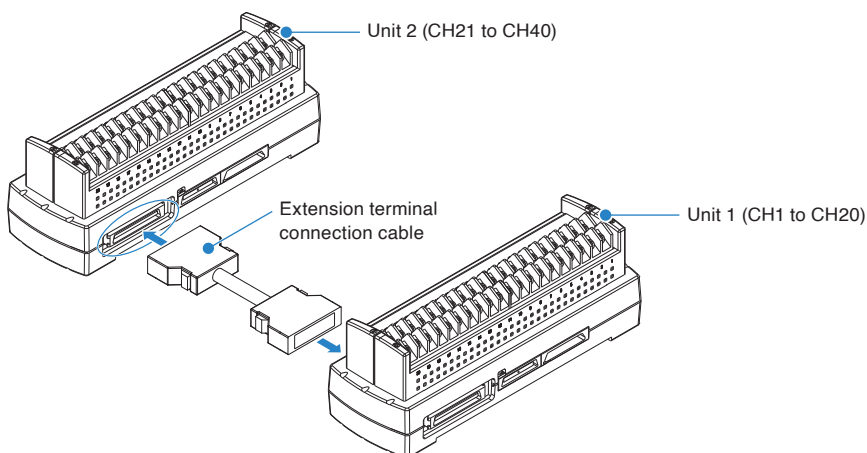

2. Connect each between the extension terminal bases with the extension terminal connection cable.

- * Insert the extension terminal connection cable until the cable is securely locked. Install the extension terminal bases in a stable location and be careful not to fall.

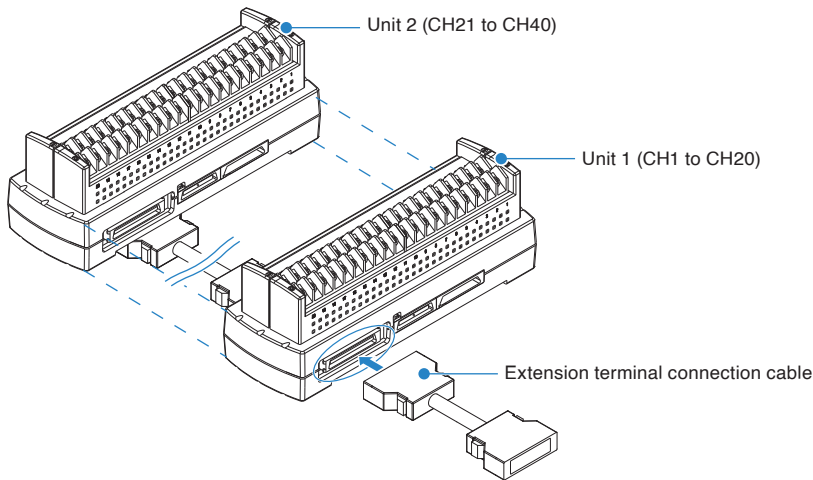

3. Connect one end of the extension terminal connection cable to the GL860.

- * Insert the extension terminal connection cable until the cable is securely locked.

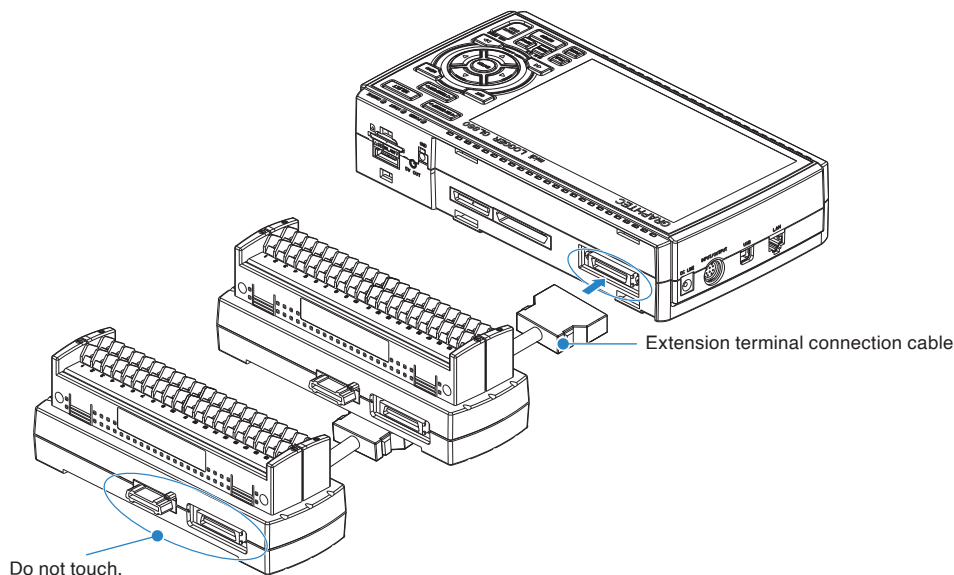

CAUTION

- While the signal is input to the direct-connected terminal, please do not touch the connector pins and terminal next to the connector.
- When removing the extension terminal connection cable from the GL860 or the extension terminal base, please note the following:
 - Please always pull out straightly in a state where both sides of the lock release lever are pushed.
 - Please do not forcibly remove or do not pull out in a state where only one side of the lock release lever is pushed. It may cause a connection failure of the connector, please be careful when you remove it.
- When the extension terminal cable is used, it becomes susceptible to noise.
- When the combination of the Standard 20CH screw terminal and Withstand high-voltage high-precision terminal is used, the withstand voltage specification of the standard terminal is applied.
- When using a Standard 30CH screwless terminal in combination, terminals connected across 200CH will not be recognized.
 - Example: When 190CH is implemented with eight Standard 20CH screwless terminals and one Standard 30CH screwless terminal, even if an additional Standard 20CH screwless terminal is installed, the total will be 210CH, so the additional terminal will not be recognized.

2.5 Nomenclature and Functions

This section describes the names and functions of parts of the GL860.

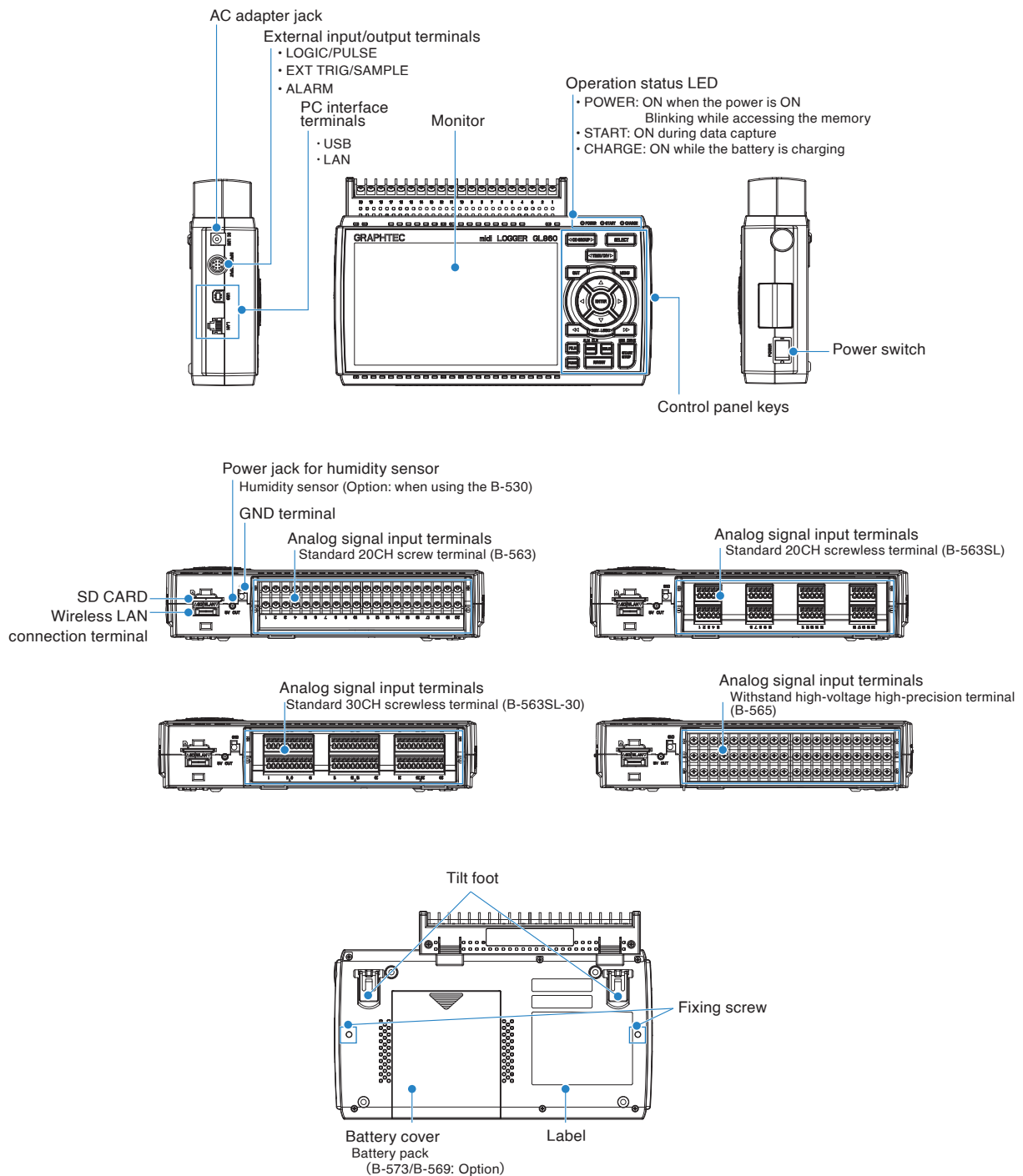

2.6 Connecting the Power Cable and Turning on the Power

This section describes how to connect the power cable and turn on the power. The connection method will vary depending on the type of power supply used.

Connecting to an AC Power Supply

Use the AC cable and AC adapter that are provided as accessories.

CAUTION

Be sure to use the AC adapter that is supplied as a standard accessory.

1. Plug the AC cable into the AC adapter.

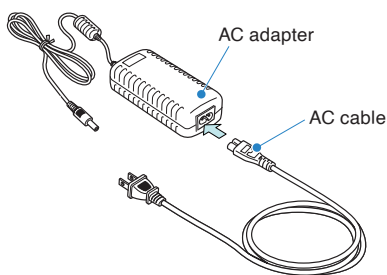

2. Connect the output side of the AC adapter to the connector on the GL860.

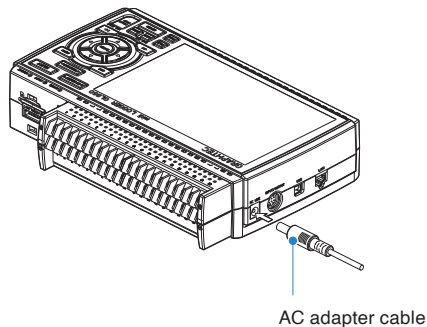

3. Using the flat-blade screwdriver, press against the minus (-) button above the GND terminal while connecting the grounding cable to the GL860.
Connect the other end of the cable to the ground.

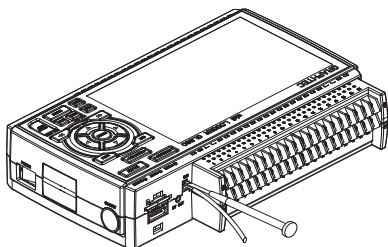

4. Plug the AC cable into the main power outlet.
5. Press the power switch on the GL860 to the ON side to turn on the power.

CAUTION

Always connect the GND terminal and refer to the safety precautions.
The GL860 must be grounded even when connected to other devices and sharing a common ground level.

Connecting to a DC Power Supply

Use the optional DC drive cable (B-514: Option).

CAUTION

- Use a power supply within the 8.5 to 26.4 VDC range.
- For DC drive cable, please be sure to use the B-514.

1. Configure the tip of the DC drive cable (B-514: 2m) to enable it to be connected to the DC power supply.
2. Connect the DC output side to the power supply connector on the GL860.

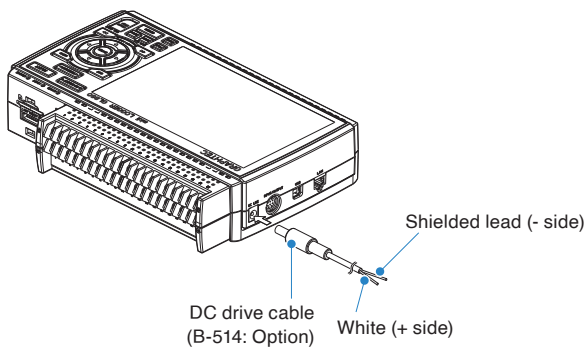

3. Connect the DC input side to the DC power supply.

CAUTION

Be sure to check the polarity of the wire tips when performing wiring.

4. Press the power switch on the GL860 to the ON side to turn on the power.

2.7 Connecting the Signal Input Cables

This section describes how to connect the signal input cables.

CAUTION

During wiring, confirm that the signal's supply source is turned OFF to prevent electrical shocks. Also, position the GL860 input cable away from any power lines and ground cables.

Terminal Configuration and Signal Types (Standard 20CH screw terminal: B-563)

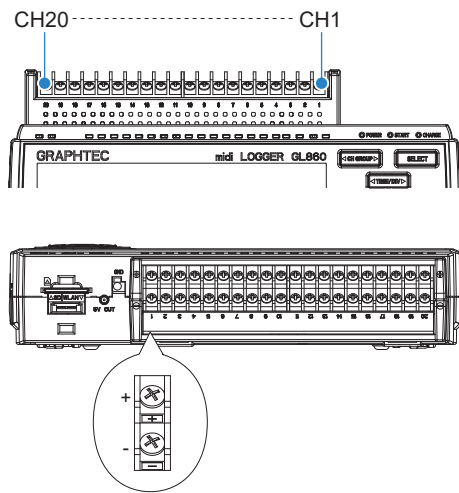

Connection diagram (Standard 20CH screw terminal: B-563)

DC voltage input

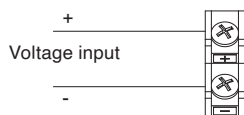

Thermocouple input

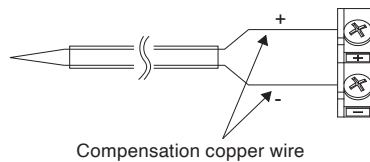

Current input

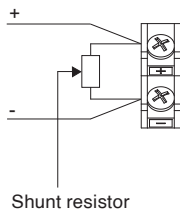

Ex: The current is converted to the voltage in the shunt resistor.
 For 4 to 20mA current input, installing 250 ohms (0.1%) resistor for converting 1 to 5V.
 * Use B-551 (option) for the shunt resistor.

- +High-voltage terminal (terminal for high-voltage input signals)
-Low-voltage terminal (terminal for low-voltage input signals)

Item	Description
Input configuration	Isolated input, scanning
Measurement range	20, 50, 100, 200, 500 mV/F.S.; 1, 2, 5, 10, 20, 50, 100 V; 1-5V/F.S.
Thermocouples	K, J, E, T, R, S, B, N, C (W: WRe 5-26)
A/D resolution	16-bit (Effective resolution: Approx. 1/40,000 of the +/- range)
Filter	Off, 2, 5, 10, 20, 40 Filter operation is on a moving average basis. The average value of the set sampling count is used. If the sample interval exceeds 30 seconds, the average value of data obtained in a sub-sample (30 seconds) is used.

Terminal Configuration and Signal Types
(Standard 20CH screwless terminal: B-563SL)

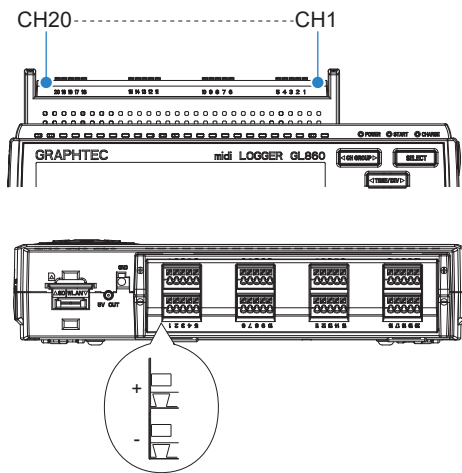

Connection diagram
(Standard 20CH screwless terminal: B-563SL)

DC voltage input

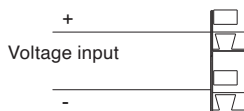

Thermocouple input

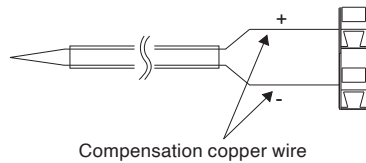

Current input

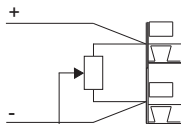

Shunt resistor

Ex: The current is converted to the voltage in the shunt resistor.

For 4 to 20mA current input, installing 250 ohms (0.1%) resistor for converting 1 to 5V.

+High-voltage terminal (terminal for high-voltage input signals)

-Low-voltage terminal (terminal for low-voltage input signals)

Item	Description
Input configuration	Isolated input, scanning
Measurement range	20, 50, 100, 200, 500 mV/F.S.; 1, 2, 5, 10, 20, 50, 100 V; 1-5V/F.S.
Thermocouples	K, J, E, T, R, S, B, N, C (W: WRe 5-26)
A/D resolution	16-bit (Effective resolution: Approx. 1/40,000 of the +/- range)
Filter	Off, 2, 5, 10, 20, 40 Filter operation is on a moving average basis. The average value of the set sampling count is used. If the sample interval exceeds 30 seconds, the average value of data obtained in a sub-sample (30 seconds) is used.

Terminal Configuration and Signal Types
(Standard 30CH screwless terminal: B-563SL-30)

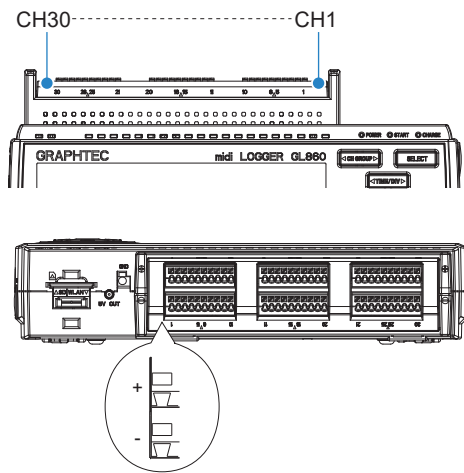

Connection diagram
(Standard 30CH screwless terminal: B-563SL-30)

DC voltage input

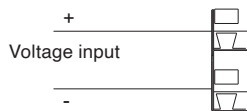

Thermocouple input

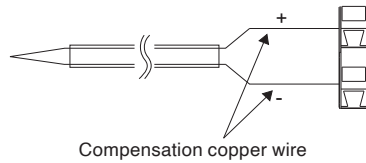

Current input

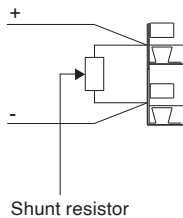

Ex: The current is converted to the voltage in the shunt resistor.
For 4 to 20mA current input, installing 250 ohms (0.1%) resistor for converting 1 to 5V.

- +High-voltage terminal (terminal for high-voltage input signals)
-Low-voltage terminal (terminal for low-voltage input signals)

Item	Description
Input configuration	Isolated input, scanning
Measurement range	20, 50, 100, 200, 500 mV/F.S.; 1, 2, 5, 10, 20, 50, 100 V; 1-5V/F.S.
Thermocouples	K, J, E, T, R, S, B, N, C (W: WRe 5-26)
A/D resolution	16-bit (Effective resolution: Approx. 1/40,000 of the +/- range)
Filter	Off, 2, 5, 10, 20, 40 Filter operation is on a moving average basis. The average value of the set sampling count is used. If the sample interval exceeds 30 seconds, the average value of data obtained in a sub-sample (30 seconds) is used.

Terminal Configuration and Signal Types
(Withstand high-voltage high-precision terminal: B-565)

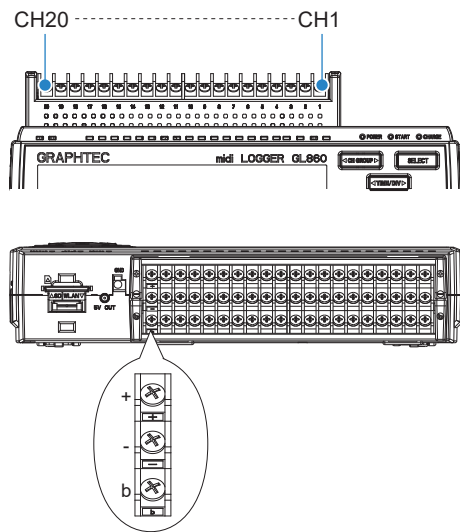

Connection diagram
(Withstand high-voltage high-precision terminal: B-565)

DC voltage input

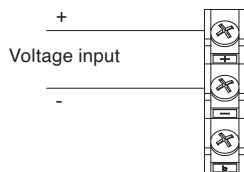

Thermocouple input

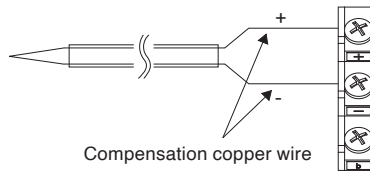

*Use B-551 (option) for the shunt resistor.

Current input

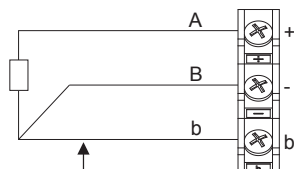

The lead wire resistance per line should be 10Ω or less, and the resistance values of the three lines should be equal.

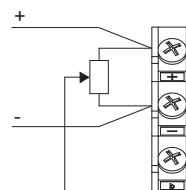

Shunt resistor

Ex: The current is converted to the voltage in the shunt resistor.
For 4 to 20mA current input, installing 250 ohms (0.1%) resistor for converting 1 to 5V.

* Use B-551 (option) for the shunt resistor.

- +High-voltage terminal (terminal for high-voltage input signals)
 -Low-voltage terminal (terminal for low-voltage input signals)
 - bDedicated terminal when connecting resistance bulb
- * Resistance bulb input terminals A (+) and B (-) are isolated within each channel. Terminal b is shorted within all channels.

Item	Description
Input configuration	Isolated input, scanning
Measurement range	20, 50, 100, 200, 500 mV/F.S.; 1, 2, 5, 10, 20, 50, 100 V; 1-5V/F.S.
Thermocouples	K, J, E, T, R, S, B, N, C (W: WRe 5-26)
Resistance bulb	Pt100, JPt100, Pt1000 (IEC751)
A/D resolution	16-bit (Effective resolution: Approx. 1/40,000 of the +/- range)
Filter	Off, 2, 5, 10, 20, 40 Filter operation is on a moving average basis. The average value of the set sampling count is used. If the sample interval exceeds 30 seconds, the average value of data obtained in a sub-sample (30 seconds) is used.

2.8 Logic Alarm Cable Connection and Functions

This section describes how to connect the logic alarm cables and the functions of cable.

CAUTION

During wiring, confirm that the signal's supply source is turned OFF to prevent electrical shocks. Also, position the GL860 input cable away from any power lines and ground cables.

The Input/output cable for GL (B-513: Option) enables logic/pulse input, external trigger input, and alarm signal output. Connect the Input/output cable for GL (B-513: Option) to the external input/output terminal as shown below.

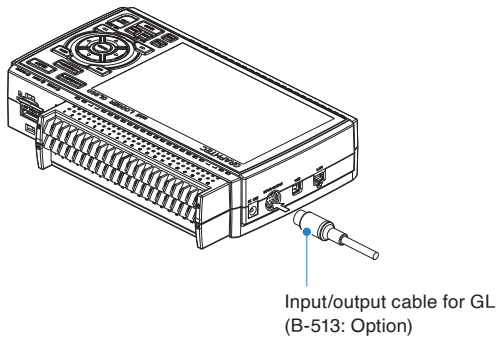

Input/output cable for GL
(B-513: Option)

Logic/Pulse Input Specifications

Item	Description
Number of input channels	4
Input voltage range	0 to +24 V max. (single-ended ground input)

* Switch between logic and pulse input.

Trigger Input/External Sampling Input Specifications

Item	Description
Number of input channels	1
Input voltage range	0 to +24 V max. (single-ended ground input)

Alarm Output Specifications

Item	Description
Number of Output channels	4
Output format	Open collector output +5 V, 10 K Ω pull-up resistance * See the next page for details on alarm output

CAUTION

When the power is turned OFF or ON, the GL860 temporarily becomes the alarm state.

Internal equivalent circuit of I/O circuit

Alarm output

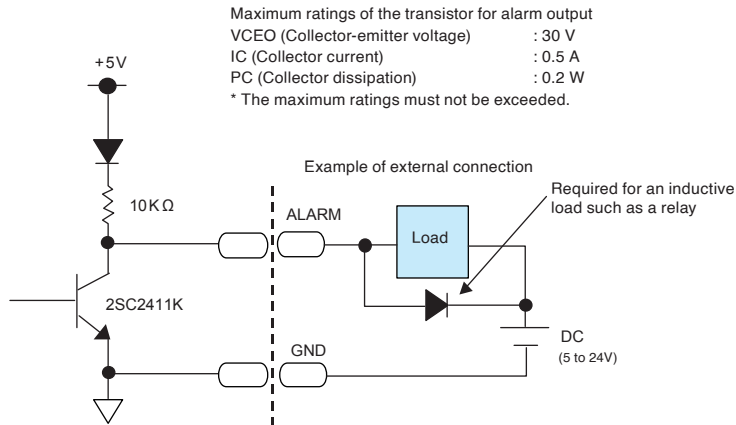

Logic/Pulse input

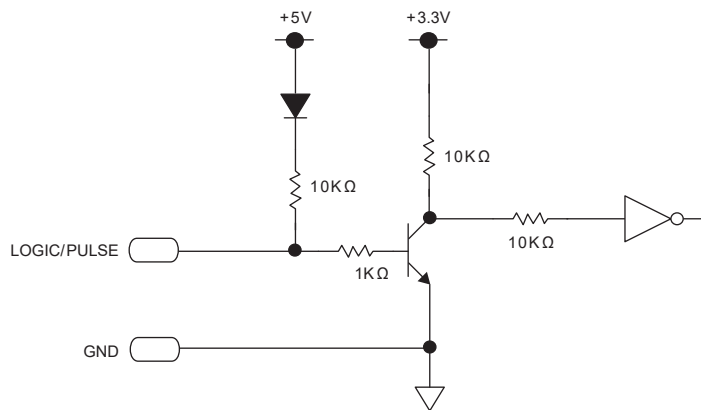

Trigger input/External sampling input

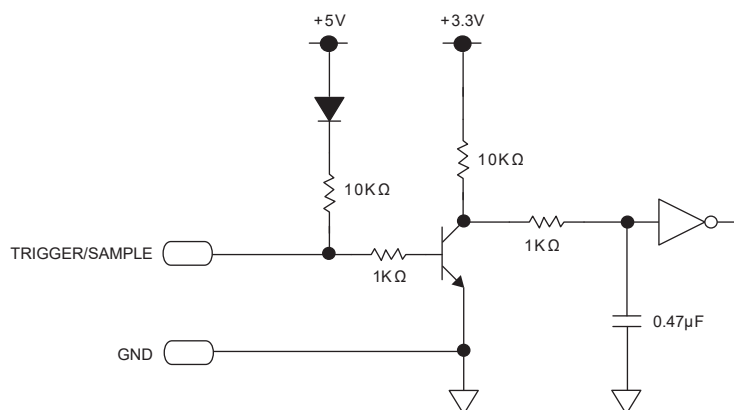

Wiring

Cable tips are bare tips. Perform wiring for the necessary functions.

Signal Name	Channel Number	Wire Color
Logic/Pulse input	1	Orange with red dotted line
	2	Orange with black dotted line
	3	Grey with red dotted line
	4	Grey with black dotted line
Alarm output	1	White with red dotted line
	2	White with black dotted line
	3	Yellow with red dotted line
	4	Yellow with black dotted
Trigger input/External sampling input		Pink with red dotted line
GND		Pink with black dotted line
		Shielded

* Switch between logic and pulse.

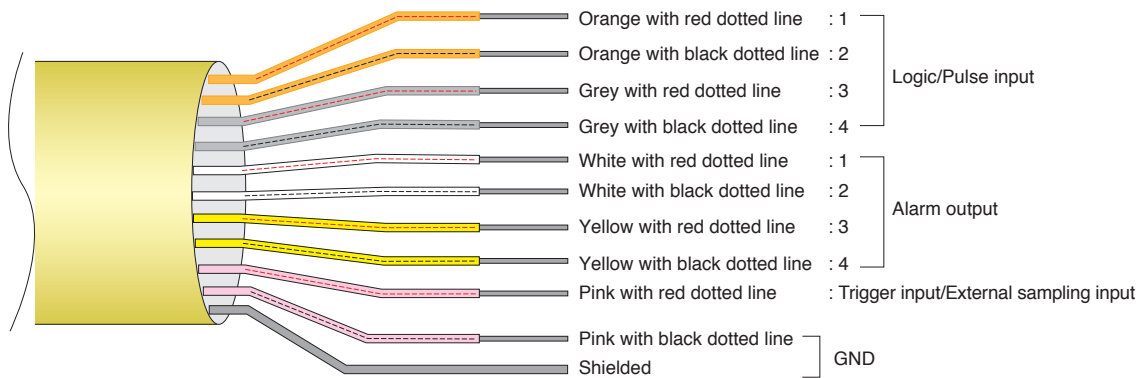

2.9 Mounting the SD Memory Card

How to insert the SD memory card

Insert the SD memory card into the SD CARD slot.

CAUTION

When the optional wireless LAN unit is installed, the SD memory card cannot be inserted.

1. Remove the SD CARD protective cover.

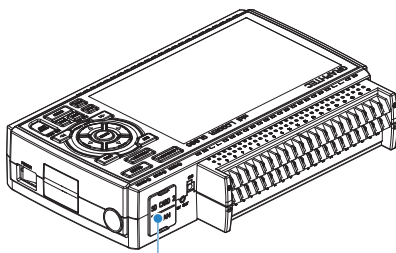

SD CARD Protective cover

2. Insert the SD memory card until it clicks and is locked.

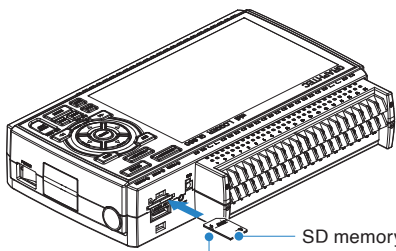

* Make sure that the SD memory card is not locked.

CAUTION

- When inserting an SD CARD, make sure that the LOCK notch is not in the LOCK (write-protected) state. If locked, the data cannot be captured.

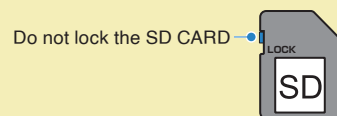

- Please do not remove the SD memory card while accessing to the SD memory card (Device Access display is displayed in "red" and POWER LED is blinking.). The captured data may be damaged.



Device access display screen

POWER (flashing)



- When inserting the large capacity SD memory card, it may take some time to recognize it.

3. Insert and close the protective cover into the upper hole and lower hole for the SD CARD protective cover.

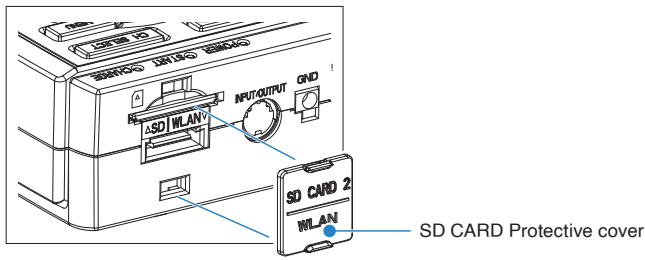

How to remove the SD memory card

1. Make sure that the SD memory card displayed on the screen is green, and the POWER LED lights up before removing it.

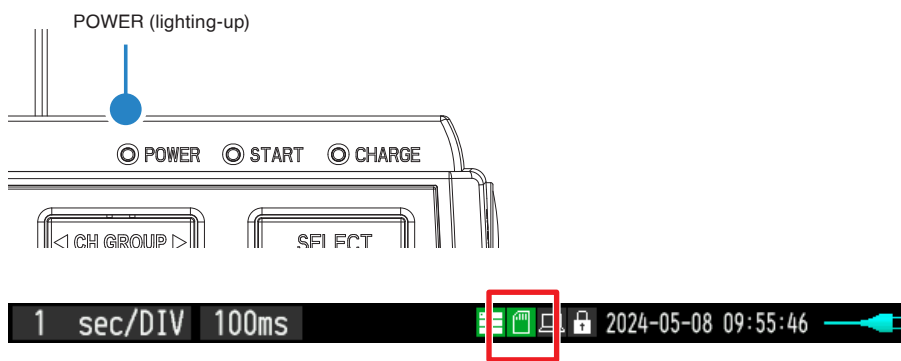

CAUTION

The device access display turns red while the SD CARD is being accessed (POWER LED is blinking). Remove the device only when the device access display is green.

2. Open the SD CARD protective cover.
3. The SD memory card is unlocked by pushing gently the SD memory card. Then, remove the SD memory card.
4. Attach it by aligning it with the top and bottom holes of the SD CARD protective cover.

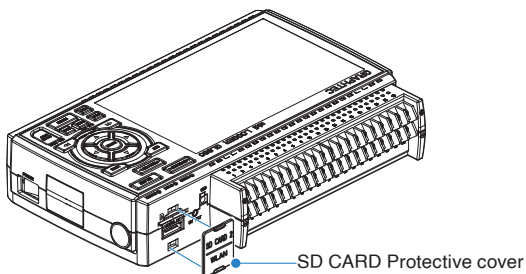

2.10 Installing the Wireless LAN Unit (B-568: Option)

To connect the GL860 to the wireless LAN, attach the wireless LAN unit to the wireless LAN connection terminal.

CAUTION

- When the SD memory card has been inserted into the SD CARD slot, please remove the SD memory card.
- When the wireless LAN unit has been inserted, the SD memory card cannot be inserted into the SD CARD slot.
- When inserting the wireless LAN unit, please make sure that the power is turned OFF and then install the unit.
- When using the wireless LAN, please check the “3. Notes on Radio Law” in the “Notes on Use” described above.

How to insert the wireless LAN unit

Insert the wireless LAN unit into the SD CARD slot.



Wireless LAN unit
(Option: B-568)

1. Turn OFF the GL860's power.
2. Remove the SD CARD protective cover.
 - * Please keep so as not to lose the SD CARD protective cover.

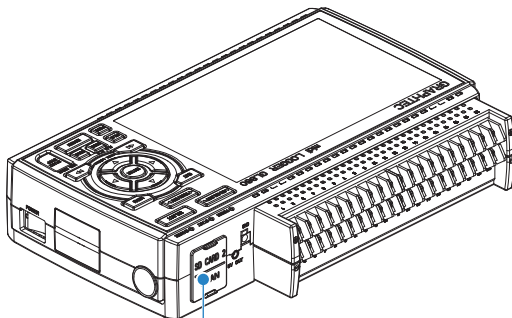

SD CARD Protective cover

3. When the SD memory card has been inserted, remove the SD memory card.
 - * The SD memory card is unlocked by pushing gently the SD memory card. Then, remove the SD memory card.

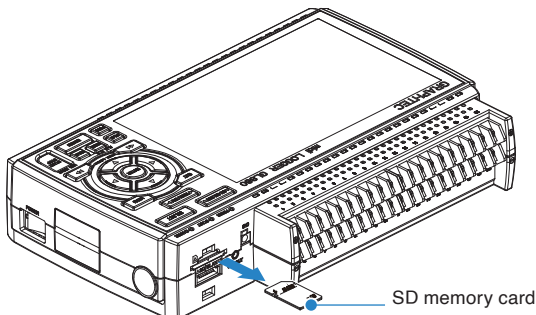

SD memory card

- Align the wireless LAN unit to the wireless LAN connection terminal and the fixed guide and then insert the wireless LAN unit until the unit is locked.

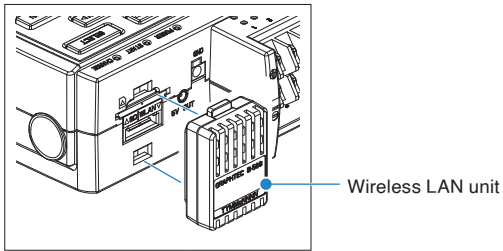

⚠ CAUTION

When the wireless LAN unit has been inserted, please be careful when handling so as not to hit and drop.

Removing the wireless LAN unit

Turn OFF the power and then remove the wireless LAN unit.

- Push the lock part on the wireless LAN unit to unlock, and then remove it.

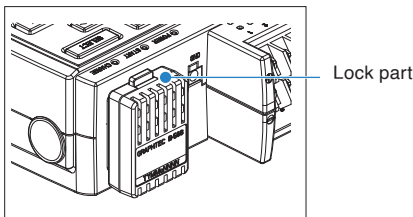

- After removing it, mount the SD CARD protective cover to protect the connectors.

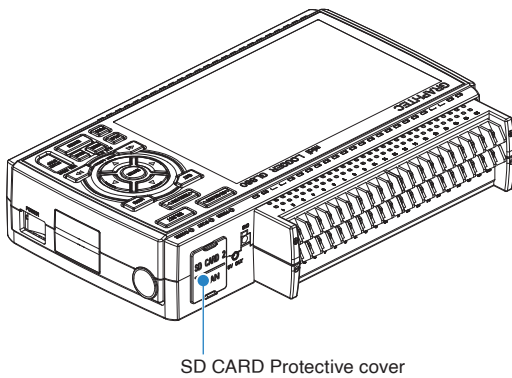

2.11 Connecting to a PC

Use the USB or LAN Interface to connect the GL860 to a PC.

Connection Using a USB Cable

Connect between the GL860 and PC with the USB cable.

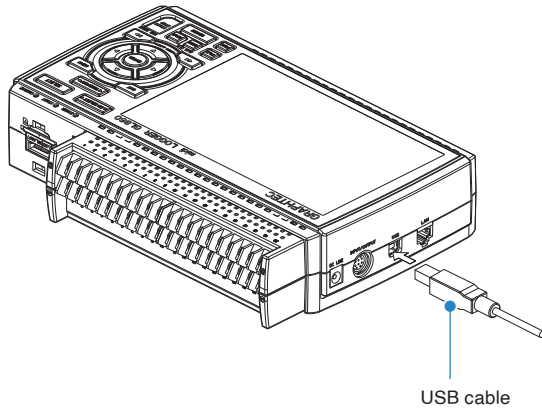

CAUTION

The USB connector is adjacent to the LAN connector. Make sure the cable is inserted into the correct connector.

Checkpoint

If the USB cable is used, the USB driver must be installed in your PC. For the installation procedure, refer to the attached "USB Driver Installation Manual".

Use the cable with A and B connectors to connect the GL860 to a PC.

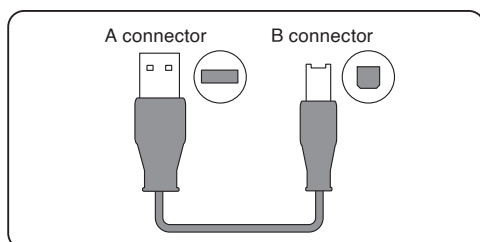

LAN Connection

Use a LAN cable to connect the GL860 to a PC.

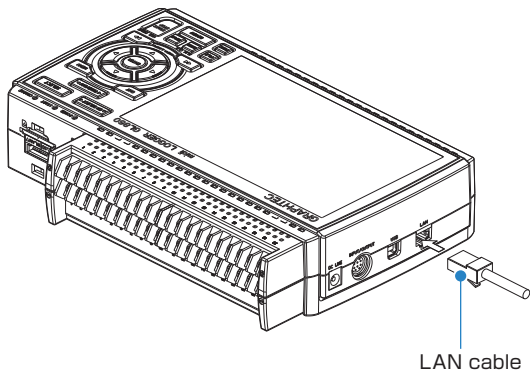

Cable Types

Use a crossing cable when connecting directly to a PC, without using a hub.

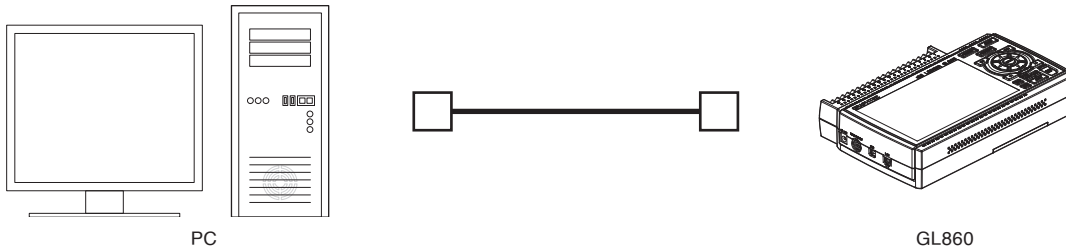

Use a straight cable when using a hub.

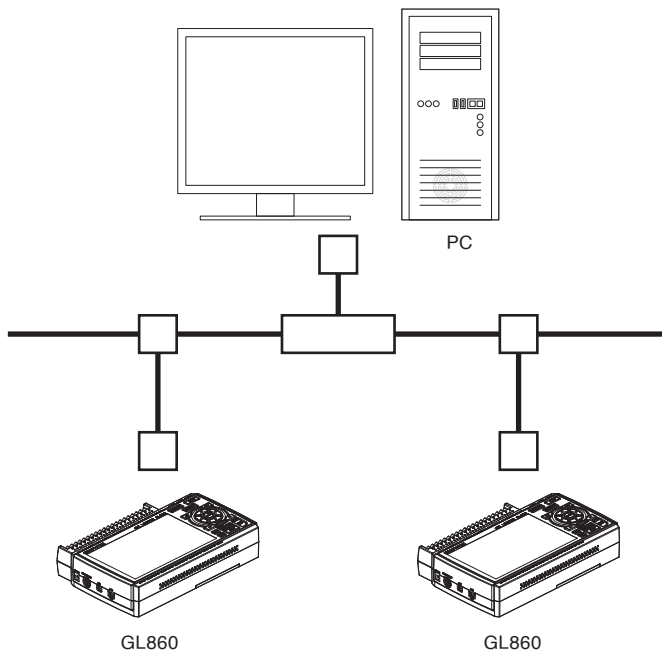

Connection through the wireless LAN (Option)

Insert the wireless LAN unit (B-568: Option).

For the insertion, refer to "2.10 Installing the Wireless LAN Unit (B-568: Option)".

1. Access point (operating as a base unit):

The following devices and operating environments are required to connect the GL860 to a PC or smartphone via wireless LAN.

- PC and Smartphone which can connect to the wireless LAN

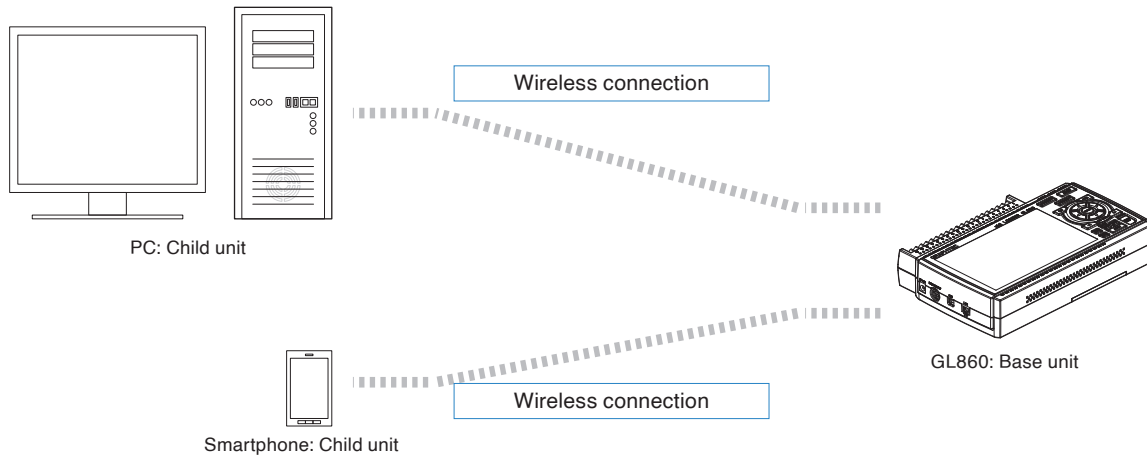

2. Stations (operating as a child unit):

When connecting to the commercially available wireless LAN base unit and controlling multiple GL860s from a PC, the following devices and the operating environment are required.

- PC and Smartphone which can connect to the wireless LAN with the dedicated software
- Wireless LAN base unit (equipped with the functions of Wi-Fi authenticated wireless LAN base unit.)
- Internet environment for Internet connection (Internet provider's contracts and mobile carrier's contracts)
- Internet connection and e-mail send/receive environment (Internet provider and Webmail, etc.) when sending/receiving e-mail.

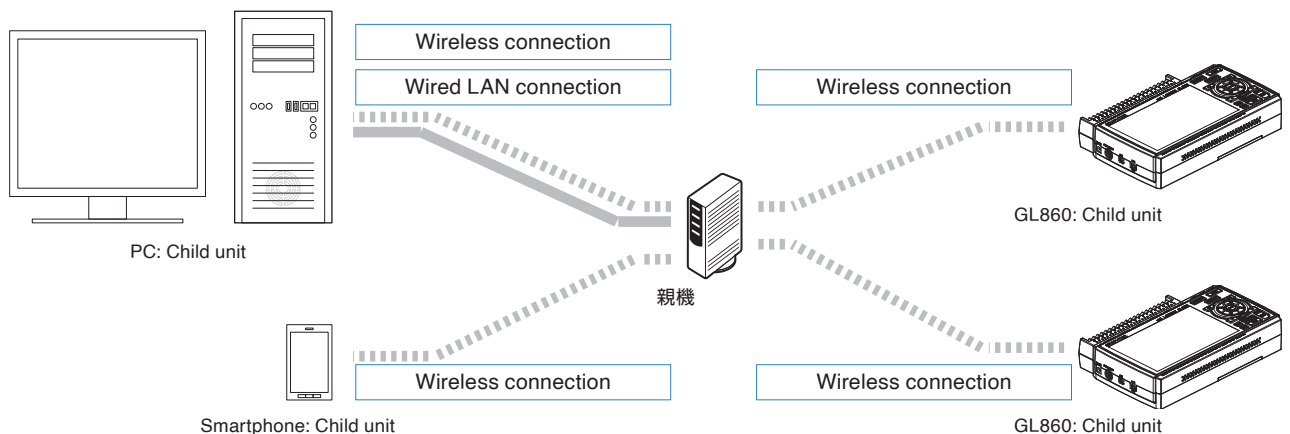

2.12 Using the Battery Pack (B-573/B-569: Option)

- The B-573/B-569 option is the only battery type that can be used with the GL860.
- Refer to "5.3 Accessories/Optional Accessories" for information on the battery run time.
- The operating temperature ranges of the GL860 with a battery pack mounted are as follows:
Running on battery: 0 to 40°C
Battery being charged: 15 to 35°C

Mounting the Battery Pack

1. While lightly pushing the grip of the battery cover, slide the cover in the direction indicated by the arrow.

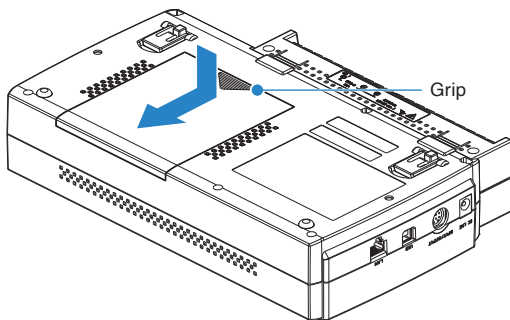

2. Attach the battery pack (B-573).

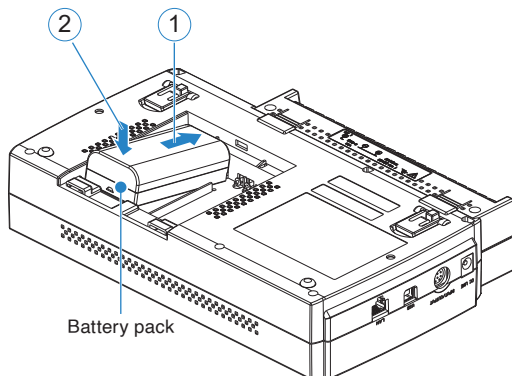

Checkpoint

- Either one or two battery packs can be attached.
- To connect one pack, connect to either one of the connectors.
- Attaching two battery packs allows longer operational time.

CAUTION

- When attaching two battery packs, make sure the battery levels are equivalent.
- Do not use a new battery with an old battery at the same time.
- When attaching two battery packs, make sure the remaining amount are same.
- If you are not sure about the amount, charge each battery and then attach full-charged two battery packs.

3. Attach the battery cover.

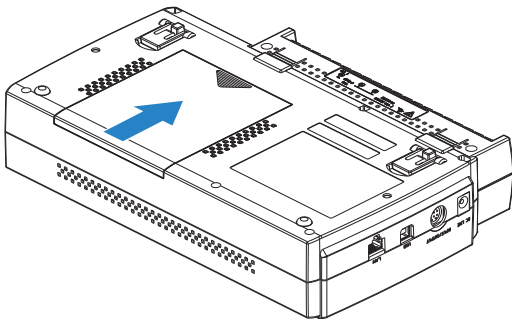

Charging the Battery

Expected time required for charging

- Battery pack x 1: approx. 5 hours
- Battery pack x 2: approx. 10 hours

The battery pack is charged by mounting it in the GL860 and attaching AC adapter to the GL860.

1. Mount the battery pack in the GL860 (see “Mounting the Battery Pack” on the previous page for the mounting procedure.).
2. Connect the GL860 to the AC power supply (see “2.6 Connecting the Power Cable and Turning on the Power”).
3. The CHARGE LED lights.

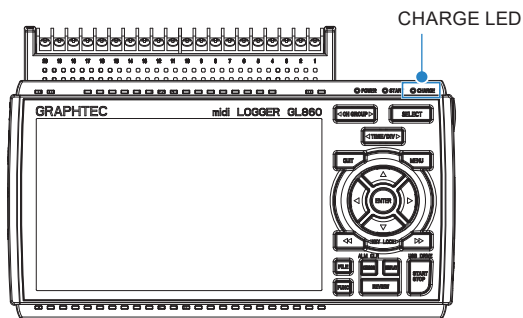

Checkpoint

- GL860 is equipped with a temperature monitor function which starts automatic charging as soon as it is cooled down. Therefore, depending on the internal temperature, charging may not be performed immediately.
- The operating temperature range during charge is from 15 to 35°C.
- When charging is attempted while the power is ON, charging may not be performed immediately even if the temperature environment conforms to the specification. In such a case, set the Screen Saver settings to ON or perform charging while the power is OFF.

CAUTION

- During data capture, the file is closed automatically when the battery capacity is lower.
- When using with the AC adapter, the GL860 is automatically battery-powered in case of power outage.
- During the power is supplied directly from the DC power without using the AC adapter, the battery charge is disabled when the DC voltage is 16V or less.

2.13 Connecting the Humidity Sensor

Connect the + and – lead wires of the humidity sensor (B-530: Option) to the desired terminals, and then insert the round connector into the 5V OUT connector on the GL860.

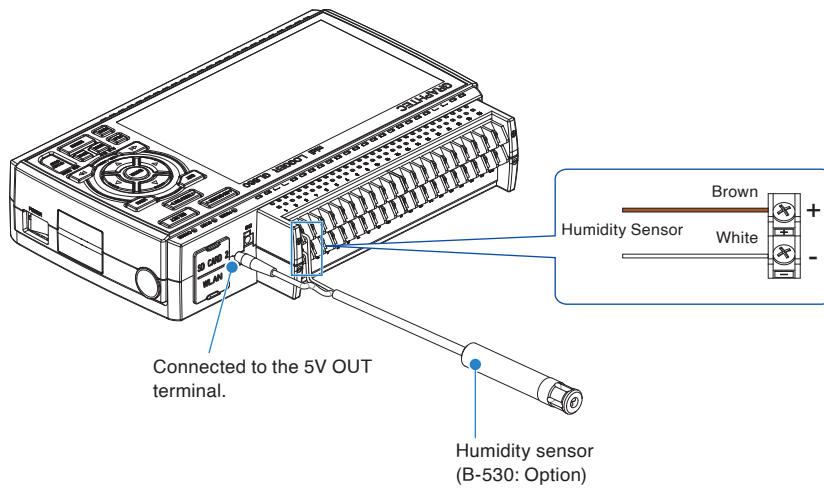

CAUTION

- Do not use the sensor in the vicinity of other devices which are susceptible to electromagnetic interference. Measured results may not satisfy the stated.
- The 5V OUT terminal on the GL860 is available for only one humidity sensor.

2.14 Precautions to Observe When Performing Measurement

Please be sure to read the following carefully in order to prevent electric shocks or shorts.

CAUTION

- Do not apply radio-frequency signals with high voltage (50 KHz or above).
- Be sure to use only the AC adapter provided as a standard accessory. The rated power supply range for the adapter is 100 to 240 VAC, and the rated frequency is 50/60 Hz. Do not use any other voltages.
- Do not input the voltage that is exceeding the specification of this device.
 - If a voltage exceeding the specified value is input, the semiconductor relay in the input section will be damaged. Never input a voltage exceeding the specified value even for a moment. It will cause a fire.
 - Have enough margin from the specification of withstanding voltage when using this device, it has to consider a noise and change of the measurement voltage.
 - Confirm this device is not broken before the input cable is connected to the input terminal.
 - Please take care of static electricity when the connecting the input cables or the thermocouples.
 - Do not touch the tip of thermocouples with bare hand after the thermocouples are connected to the terminal of this device when the tip of thermocouples is not insulated.
 - The static electricity of a human body will cause damage to this device.
 - Do not put the tip of thermocouples to the object which is containing the static electricity when the tip of thermocouples is not insulated. The static electricity of object will cause damage to this device.
 - Do not put the tip of thermocouples to the object which is containing the leaked high voltage of chassis or metal etc. when the tip of thermocouples is not insulated.
 - The leaked high voltage of object will cause damage to this device.
 - We recommend that the insulation tape puts on the tip of thermocouples before connecting the thermocouples to the input terminals.
 - This will protect this device from the static electricity and the leaked high voltage.
- * This applies to all the channels even if channel extension is used.
- * The specification of all channels becomes the B-563 (B-563SL/B-563SL-30), when the B-563 (B-563SL/B-563SL-30) and the B-565 are installed.

When using the Standard terminal (B-563/B-563SL/ B-563SL-30)

Maximum input voltage

If a voltage exceeding the specified value is input, the semiconductor relay in the input section will be damaged. Never input a voltage exceeding the specified value even for a moment.

< Between +/- terminals (A) >

Maximum input voltage: 60Vp-p (Range of 20mV to 2V)
110Vp-p (Range of 5V to 100V)

<Between input terminal/input terminal (B) >

Maximum input voltage: 60Vp-p
Withstand voltage: 350Vp-p at 1 minute

<Between input terminal/GND (C) >

Maximum input voltage: 60Vp-p
Withstand voltage: 350Vp-p at 1 minute

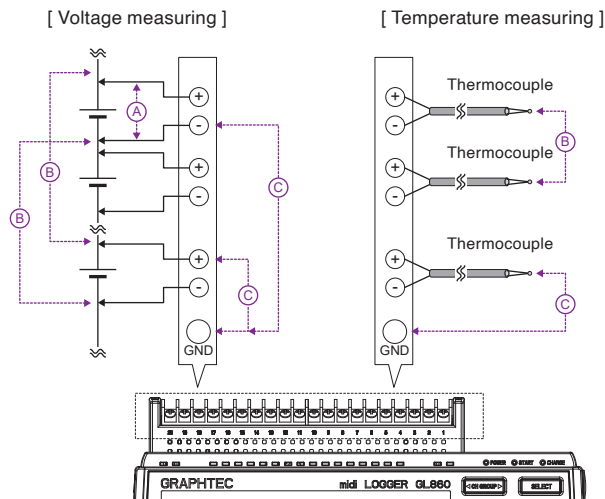

Input Circuit Diagram for Analog Input (Voltage, Thermocouples)

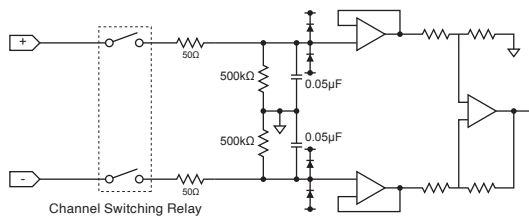

CAUTION

Capacitors have been incorporated into the input circuit to increase the noise-elimination capability. After voltage measurement, when the inputs have been disconnected, there will still be some electric charge remaining. Before starting another measurement operation, short-circuit the + and – terminals to enable self-discharge. The GL860 has a scan system. While in the status (open) in which signals are not input to the input terminal, measured results may be influenced by signals from other channels. In such a case, turn OFF the input setting or short circuit +/- . If signals are input correctly, measured results are not influenced by other channels.

When using the Withstand high-voltage high-precision terminal (B-565)

Maximum input voltage

If a voltage exceeding the specified value is input, the semiconductor relay in the input section will be damaged. Never input a voltage exceeding the specified value even for a moment.

* This applies to all the channels even if channel extension is used.

< Between +/- terminals (A) >

Maximum input voltage: 60Vp-p (Range of 20mV to 2V)
110Vp-p (Range of 5V to 100V)

<Between input terminal/input terminal (B) >

Maximum input voltage: 600Vp-p
Withstand voltage: 600Vp-p

<Between input terminal/GND (C) >

Maximum input voltage: 300Vp-p
Withstand voltage: 2300Vp-p at 1 minute

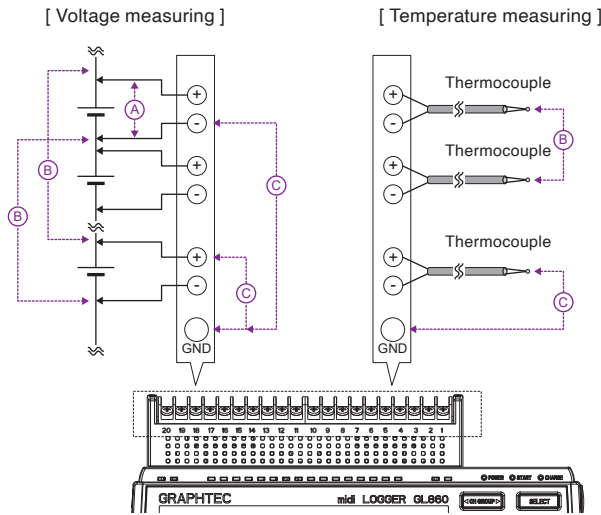

Input Circuit Diagram for Analog Input (Voltage, Thermocouples)

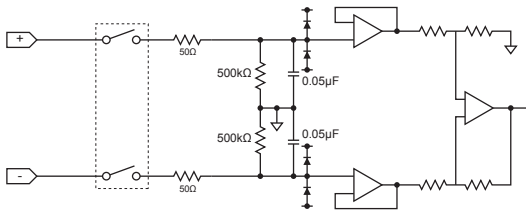

CAUTION

Capacitors have been incorporated into the input circuit to increase the noise-elimination capability. After voltage measurement, when the inputs have been disconnected, there will still be some electric charge remaining. Before starting another measurement operation, short-circuit the + and – terminals to enable self-discharge. The GL860 has a scan system. While in the status (open) in which signals are not input to the input terminal, measured results may be influenced by signals from other channels. In such a case, turn OFF the input setting or short circuit +/-.

If signals are input correctly, measured results are not influenced by other channels.

2.15 Noise Countermeasures

Be sure to connect the chassis GND of the measurement object.

It may become effective by ensuring that the chassis GND wire of the measurement object is connected to good ground.

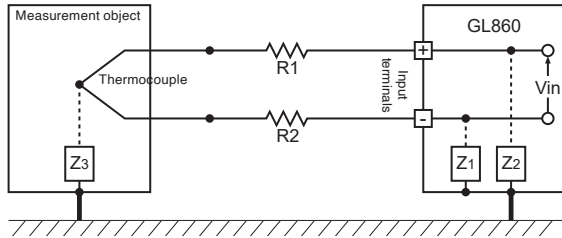

Connect the signal chassis GND to the measurement device chassis ground.

Use a short, thick lead to connect the chassis GND of the measurement object to the GL860's chassis GND. It will become even more effective if the ground potentials are the same.

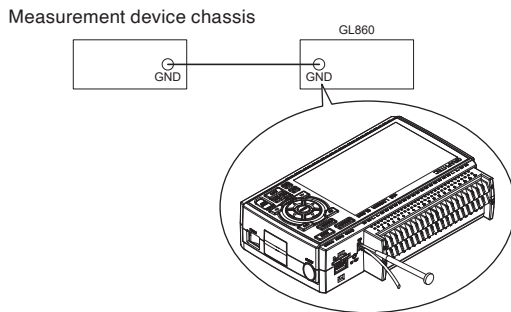

Noise countermeasures

If measured values fluctuate due to extraneous noise, conduct the following countermeasures. (Results may differ according to noise type.)

- Ex 1: Connect the GL860's GND to the ground.
- Ex 2: Connect GL860's GND to the measurement object's GND.
- Ex 3: In the AMP settings menu, set the filter to any setting other than "OFF".
- Ex 4: Set the sampling interval which enables GL860's digital filter.
Use the "OTHER" menu to set the commercial power frequency you use.
Refer to "3.4 Setting Menus" for details.

2.16 When Fixing the GL860 Main Unit

Fixing the GL860 Main Unit

When fixing the GL860 main unit to prevent the dropout of the GL860, the two nuts on the back must be used.

* Recommended tightening torque: 14kgf/cm

When fixing the GL860, it must be installed in a horizontal state rather than in a vertical or inclined state.

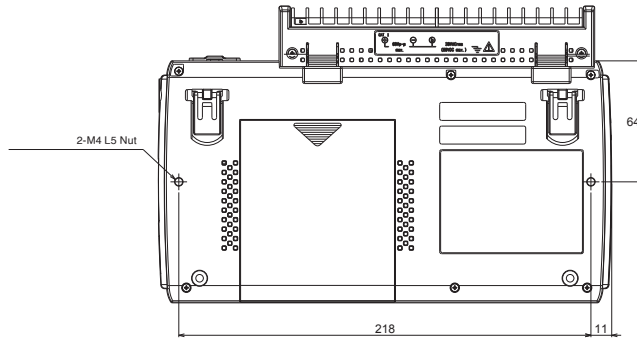

CAUTION

To prevent possible malfunction, do not block the air vents of the GL860.

If the GL860 is installed in other than the state described above, the measurement accuracy may not meet the specifications.

2.17 Setting the Date and Time

If you are using the GL860 for the first time, charge the internal rechargeable battery and set the date and time.

CAUTION

If the GL860 is not used for approximately six months, the internal rechargeable battery may be discharged and the date and time may revert to the initial settings. If this happens, recharge the battery before using the GL860.

How to Recharge the Rechargeable Battery

Using the AC adapter provided, connect the GL860 to a mains power outlet, turn on the power switch, and then leave the GL860 connected for at least 24 hours.

How to Set the Date and Time

Press the [MENU] key, display the "OTHER" screen, and then set the date and time at the Date/Time Settings sub-menu. For details, refer to "Date/Time" in "3.4 Setting Menus".

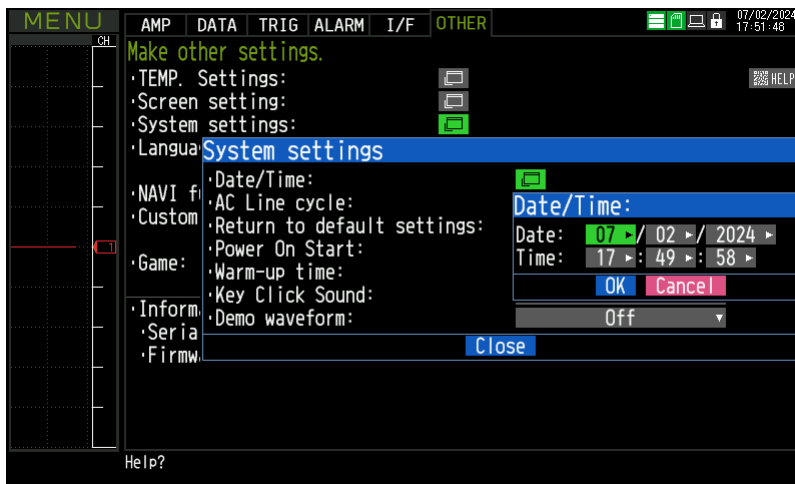

Chapter 3 Settings and Measurement

This chapter describes the setting and measurement procedures for the GL860.

SECTION IN THIS CHAPTER

- 3.1 *Name of each screen part and functions*
- 3.2 *Key Operations*
- 3.3 *Operation Modes*
- 3.4 *Setting Menus*
- 3.5 *WEB Server Function*
- 3.6 *List of Error Codes*

3.1 Name of each screen part and functions

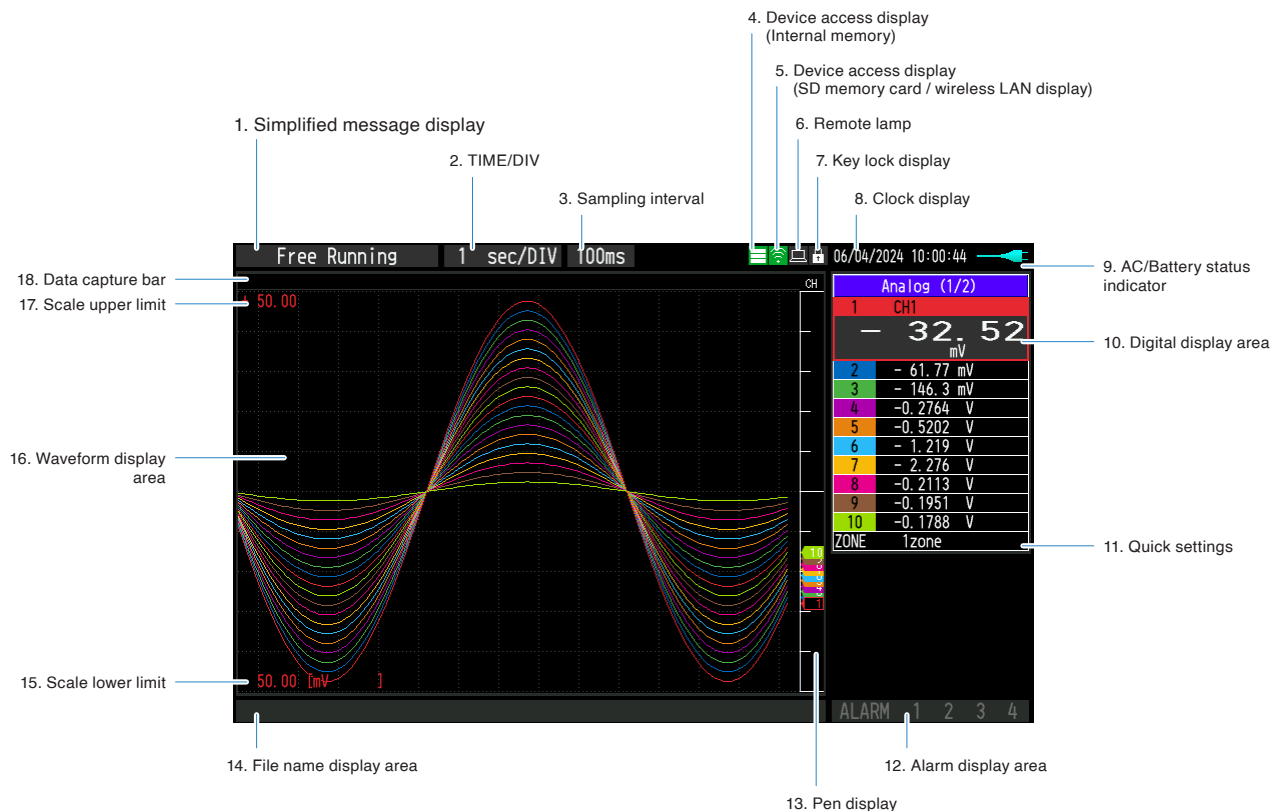

1. Simplified message display

Displays the operation status of the GL860.

- Free Running** : Appears in the start-up status or when data is not being captured.
- Armed** : Appears while waiting for trigger generation after the measurement is started.
- Rec to Int Mem** * : Displayed when the data is captured to the internal memory.
- Data capture SD card** * : Displayed when the data is captured to the SD memory card.
- Writing Disk** * : Displayed when performing the capturing stop process.
- Finished** : Appears when the GL860 waits for you to press the [START/STOP] key to stop it after data capture.
- Int Mem Review** * : Displayed when the data in the internal memory is replayed.
- SD Memory Review** * : Displayed when the data in the SD memory card is replayed.
- Backup failed** : Appears when backup fails (e.g. when the SD memory card specified as the backup destination has been removed).
- Demo Wave Mode** : Appears when a demo waveform is being displayed, not measurement data.

* Refer to "3. TRIG settings" in "3.4 Setting Menu" for details on the data capture such as a trigger and repeat.

* Refer to "2-4. Captured data file name" in "3.4 Setting Menu" for details on data capture settings.

CAUTION

Please do not turn off the power when the "*" status icon is displayed or the device is being accessed. The data that has been captured or is being captured may be damaged. Make sure the status message is "free running" before performing the next operation.

2. Time/DIV display area

Displays the current time scale.

3. Sampling interval

The currently set sampling interval is displayed.

4. Device access display (Internal memory)



: The internal memory is not being accessed.



*: The internal memory is being accessed.

The POWER LED also blinks while accessing the internal memory.

CAUTION

Please do not turn off the power when the “*” status icon is displayed or the device is being accessed. The data that has been captured or is being captured may be damaged. Make sure the display shows that it is not being accessed before performing the next operation.

5. Device access display (SD memory card / wireless LAN display)



: The SD CARD is not installed.



: The SD CARD is installed, but it is not being accessed.



*: The SD CARD is being accessed. Do not remove the SD CARD.

The POWER LED also blinks while accessing the SD CARD.

CAUTION

Please do not turn off the power when the “*” status icon is displayed or the device is being accessed. The data that has been captured or is being captured may be damaged. Please start the operation after making sure that it is not being accessed on the display.



: Displays the wireless signal strength when the wireless LAN unit is connected or when the station is set.



: When connecting a wireless LAN unit or setting an access point, the number of connected stations is displayed.

6. Remote display



: Indicates local mode. Operations can be conducted on the GL860.



: Indicates remote mode. With some exceptions, operations must be conducted on a PC.

When you cancel the connection on the application (GL28-APS/ GL-Connection), the GL860 is automatically sent back to local mode. If local mode is not entered, press the [QUIT] key.

7. Key lock display

 : Not in key lock status. Normal operations are enabled.

 : Key lock status. All the keys are locked.

Refer to "13. To cancel key lock by password" in "3.4 Setting Menus" for details on the key lock.

8. Clock display/Warm-up time

Displays the current date and time.

Refer to "6. OTHER settings" in "3.4 Setting Menus" for details on date and time settings.

From the time the power is turned on until the time set in the warm-up setting, the current date and time are displayed in the upper row, and the remaining warm-up time is displayed in the lower row.

Use this as a guide when measuring temperature with a thermocouple.

The warm-up time display disappears when the time set in the warm-up setting has passed.

Refer to "6. OTHER settings" in "3.4 Setting Menus" for warm-up time settings.

 : Normal time display

 : Warm-up time display.

9. AC/Battery status indicator

 : Running on AC or DC power supply.

 : Running on the battery. The remaining battery power is 100 to 90%.

 : Running on the battery. The remaining battery power is 89 to 70%.

 : Running on the battery. The remaining battery power is 69 to 50%.

 : Running on the battery. The remaining battery power is 49 to 30%.

 : Running on the battery. The remaining battery power is 29 to 10%.

 : Running on the battery. The remaining battery power is 10% or below.

CAUTION

- Data capture automatically stops when the remaining battery power drops to 10% or below.
- The power is automatically turned off when the remaining battery power is 0%.
- Please use the remaining battery display as a guide. This indicator does not guarantee the operating time with the battery.

10. Digital display area

The input value of each CH is displayed. Use the "CH SELECT" key to switch display categories.

 : Analog CH measurement value is displayed.

 : Logic CH measurement value is displayed.

 : Pulse CH measurement value is displayed.

 : Calculation CH calculation results are displayed.

The ON or OFF of the active channel display can be changed using the "△▽" keys.

You can select the CH to be activated with the "△" and "▽" keys. Also, for the active CH, the waveform display is displayed at the top.

CHs whose Input or Setting is set to Off are not displayed.

Refer to "1. CH GROUP" and "2. SELECT" in "3.2 Key Operation" for details.

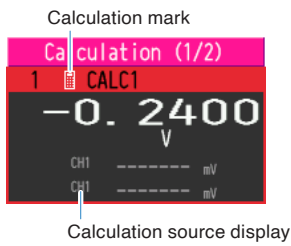
<Calculation mark>

As shown below, the CHs with the calculation mark is the CH of calculation between channels.

The digital display of the calculation CH shows the value of the analog CH that is the source of the calculation. (Calculation source display).

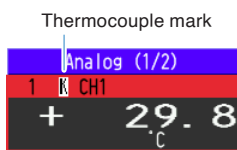
<Thermocouple mark>

The CHs with the thermocouple mark as shown above are the temperature measurement CH.

The thermocouple mark shows the type of thermocouple you have set.

<Digital display enlargement function>

If the number of CH displayed at one time is within 5 channels, the digital display will be enlarged.

[Normal display]	[Enlarged display]																																																														
<table border="1"> <tr><td colspan="2">Analog (1/2)</td></tr> <tr><td>1</td><td>CH1</td></tr> <tr><td colspan="2">+ 1.181</td></tr> <tr><td colspan="2">V</td></tr> <tr><td>2</td><td>+ 1.122 V</td></tr> <tr><td>3</td><td>+ 1.063 V</td></tr> <tr><td>4</td><td>+ 1.004 V</td></tr> <tr><td>5</td><td>+ 0.945 V</td></tr> <tr><td>6</td><td>+ 0.886 V</td></tr> <tr><td>7</td><td>+ 0.827 V</td></tr> <tr><td>8</td><td>+ 0.768 V</td></tr> <tr><td>9</td><td>+ 0.709 V</td></tr> <tr><td>10</td><td>+ 0.650 V</td></tr> <tr><td>ZONE</td><td>1zone</td></tr> </table>	Analog (1/2)		1	CH1	+ 1.181		V		2	+ 1.122 V	3	+ 1.063 V	4	+ 1.004 V	5	+ 0.945 V	6	+ 0.886 V	7	+ 0.827 V	8	+ 0.768 V	9	+ 0.709 V	10	+ 0.650 V	ZONE	1zone	<table border="1"> <tr><td colspan="2">Analog (1/2)</td></tr> <tr><td>1</td><td>CH1</td></tr> <tr><td colspan="2">- 4.741</td></tr> <tr><td colspan="2">V</td></tr> <tr><td>2</td><td>CH2</td></tr> <tr><td colspan="2">- 4.503</td></tr> <tr><td colspan="2">V</td></tr> <tr><td>3</td><td>CH3</td></tr> <tr><td colspan="2">- 4.266</td></tr> <tr><td colspan="2">V</td></tr> <tr><td>4</td><td>CH4</td></tr> <tr><td colspan="2">- 4.029</td></tr> <tr><td colspan="2">V</td></tr> <tr><td>5</td><td>CH5</td></tr> <tr><td colspan="2">- 3.792</td></tr> <tr><td colspan="2">V</td></tr> <tr><td>ZONE</td><td>1zone</td></tr> </table>	Analog (1/2)		1	CH1	- 4.741		V		2	CH2	- 4.503		V		3	CH3	- 4.266		V		4	CH4	- 4.029		V		5	CH5	- 3.792		V		ZONE	1zone
Analog (1/2)																																																															
1	CH1																																																														
+ 1.181																																																															
V																																																															
2	+ 1.122 V																																																														
3	+ 1.063 V																																																														
4	+ 1.004 V																																																														
5	+ 0.945 V																																																														
6	+ 0.886 V																																																														
7	+ 0.827 V																																																														
8	+ 0.768 V																																																														
9	+ 0.709 V																																																														
10	+ 0.650 V																																																														
ZONE	1zone																																																														
Analog (1/2)																																																															
1	CH1																																																														
- 4.741																																																															
V																																																															
2	CH2																																																														
- 4.503																																																															
V																																																															
3	CH3																																																														
- 4.266																																																															
V																																																															
4	CH4																																																														
- 4.029																																																															
V																																																															
5	CH5																																																														
- 3.792																																																															
V																																																															
ZONE	1zone																																																														

<Span/Position/Trace settings>

Pressing the [ENTER] key during waveform display displays Span/Position/Trace settings. For details, refer to "3.4 Setting Menus" – "7. Span/Position/Trace settings".

11. Quick settings

You can change the settings for dividing the waveform display. Use the " $\Delta \nabla$ " keys to activate the Quick setting and the " $\triangleleft \triangleright$ " keys to change values. For details, refer to "12. Quick setting" in "3.4 Setting Menus".

12. Alarm display area

Displays the alarm output terminal status.

The number with which an alarm has occurred is displayed in red. The channel with the alarm cause has a red digital display area.

Alarm output numbers not set to alarm are grayed out. Also, if all the alarm output numbers are not set to alarm, the entire alarm display will be grayed out.

<When all alarm output numbers are not set>

All alarms are grayed out.

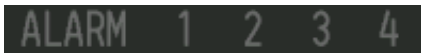

<When only alarm output number 1 is set>

Only the set alarm output numbers are displayed brightly.



<Alarm generated>

The alarm output number for which an alarm is occurring is displayed in red.



The digital display of the CH that caused the alarm also turns red.



13. Pen display

Displays each channel signal position, trigger position, and alarm range.

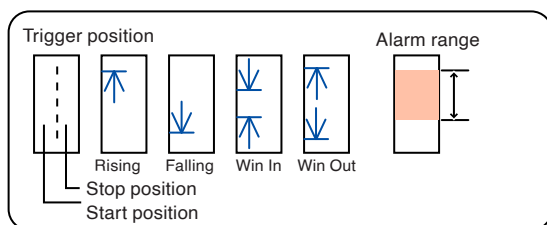

14. File name display area

<During data capture>

A capture file name is displayed during capture.

`<MEM>240605\240605-081345.GBD`

* If the ring recording setting is ON, a file name displayed during capture ends with "_RINGx" (x represents a number) but the actual file name does not include "_RINGx".

In the above figure, if the ring recording is set to ON, the file name during capture will be displayed, for example, as "<MEM>240605 \240605-081345_RING4.GBD" but the actually created file will be "<MEM>240605 \240605-081345.GBD".

* Refer to "2. DATA settings" in "3.4 Setting Menus" for details.

<During data replay>

Information on the time axis of the cursor is displayed during replay.



15. Scale lower limit

Displays the scale lower limit of the currently active channel.

16. Waveform display area

Displays the waveform of the input signal.

17. Scale upper limit

Displays the scale upper limit of the currently active channel.

18. Data capture bar

<During data capture>

Displays the elapsed time and the internal memory and SD memory card usage status.

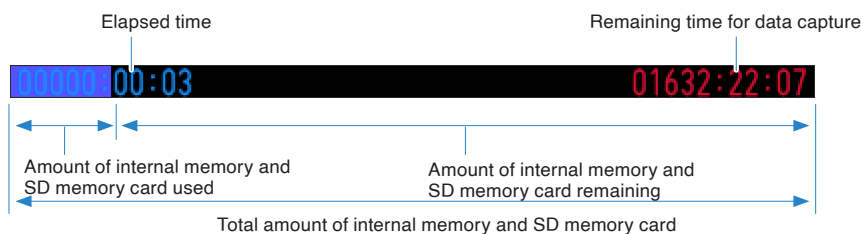

For example, a 4 GB SD memory card is inserted and about 100 MB is used before data capture, the total amount of memory is 4 GB, the amount of SD memory card used is about 100 MB, and the amount of SD memory card remaining is about 3.9 GB. As time elapses during data capture, the amount of used SD memory card increases and the amount of remaining memory decreases.

The remaining time for data capture shows the time during which data capture is available with the amount of remaining SD memory card. If the amount of remaining SD memory card is more than 2 GB, however, this part shows the remaining time during which data capture is available with one 2 GB file.

* Remaining time more than 99999 hours is displayed as "++++:++:++".

<During data replay>

Displays the display position, cursor position, and trigger position graphically.

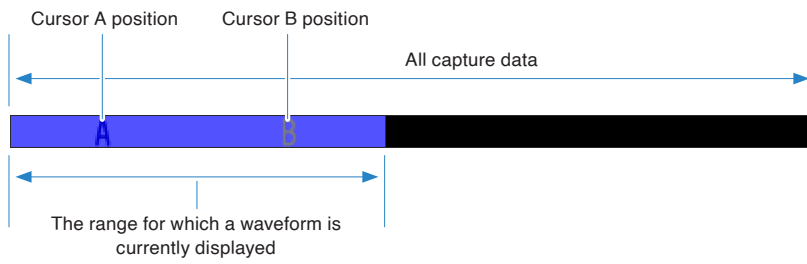

3.2 Key Operations

This section describes key operations.

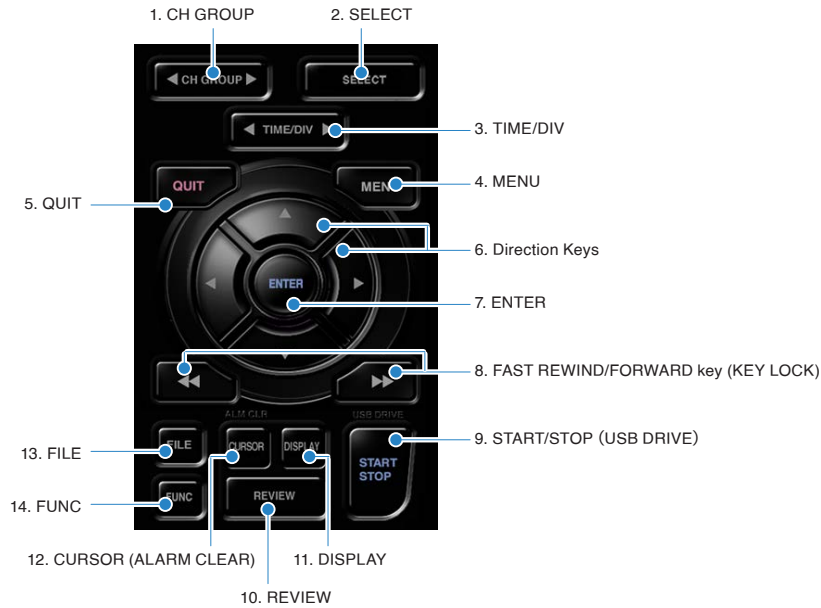

(1) CH GROUP

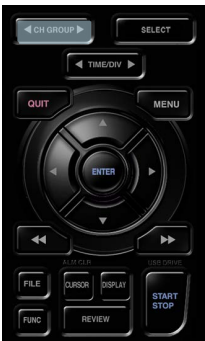

Press this key to switch to the next group consisting of 10 channels.

Press the ◀ key to switch to the group consisting of the next 10 channels with a smaller number.

Press the ▶ key to switch to the group consisting of the next 10 channels with a larger number.

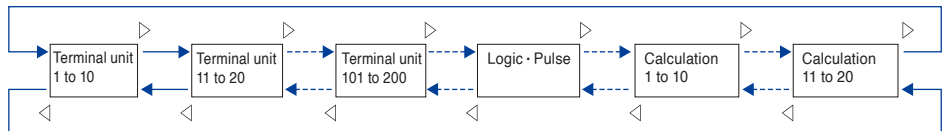

The items that can be switched in this key are as follows.

- Switch channels of the digital display area
- Switch channels of the AMP settings
- Switch channels of the trigger/alarm level settings
- Switch channels of the calculation display

Digital + Waveform screen

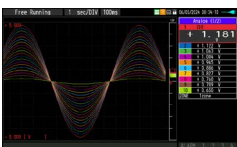

AMP settings

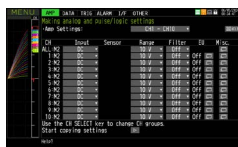

Level settings



Digital + Calculation Display screen



Statistical calculation between cursors

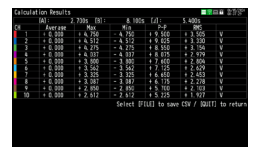

If all channels in the relevant channel group are set to off, channel group selection will be skipped.

*The first channel group in “Analog” can always be selected.

For the [AMP] settings menu, channel groups are unconditionally selectable.

Set channel groups to enable/disable in the [AMP] settings menu.

For details on the [AMP] setting menu, refer to “1. AMP settings” in “3.4 Setting Menus”.

If you press and hold this key, the channel group is displayed. You can set it directly for the channel group you want to select. Use the “ $\triangle\nabla$ ” keys to select a channel group, and press the [ENTER] key to confirm.

** Channel groups that cannot be selected are displayed in light color.

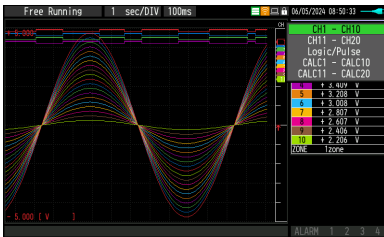

(2) SELECT

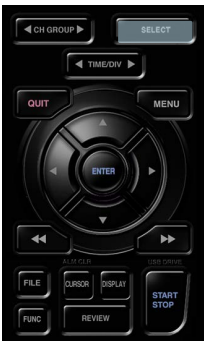

With this key, you can switch the CH category displayed in waveform display, digital display, menu setting, etc.

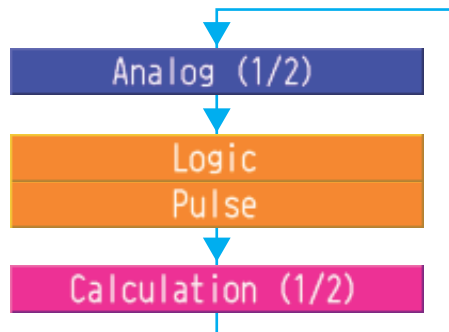

- * The “Analog” category is always selectable.
- * When the “Logic/Pulse” and “Calculation” category settings are enabled, these can be switched.
- * “Logic/Pulse” selects whichever is valid.

For the [AMP] settings menu, all categories are unconditionally selectable. Set each category to enable/disable in the [AMP] settings menu.

For details on the [AMP] setting menu, refer to “1. AMP settings” in “3.4 Setting Menus”. If you press and hold this key, the category list is displayed. You can set directly for the category you want to select. Use the “ $\triangle\nabla$ ” keys to select a category, and press the [ENTER] key to confirm.

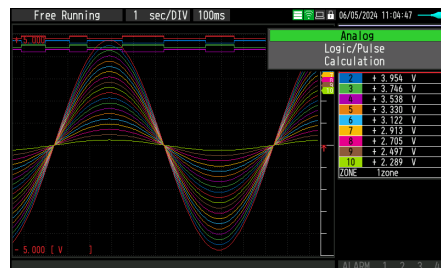

(3) TIME/DIV

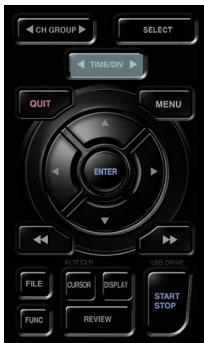

Press the left/right key of the [TIME/DIV] key to change the time axis display width.

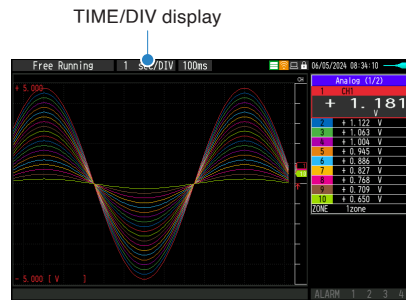

(4) MENU

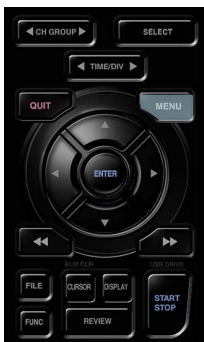

Open the settings window to capture data. For details on settings, refer to “3.4 Setting Menus”.

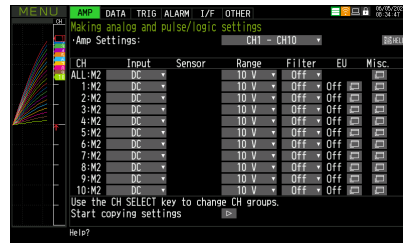

(5) QUIT (LOCAL)

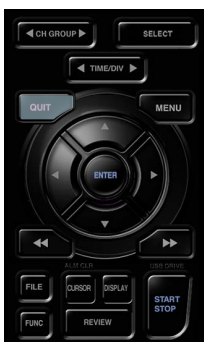

This key is primarily used for the following operations.

- To cancel a setting during menu configuration.
- To cancel remote status (in which keys are disabled) through interface control.
- To close the menu screen.
- To quit data replay.

(6) Direction Keys

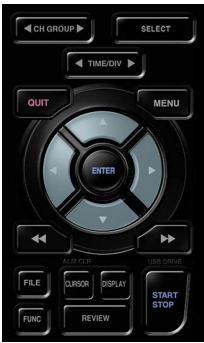

This key is primarily used for the following operations.

- To move a menu or setting item during menu configuration.
- To move the cursor during replay.
- To move the active channel in the Waveform + Digital. (“ Δ ”/“ ∇ ” keys).
- To change the Quick setting (“ \triangleleft ”/“ \triangleright ” keys).
- To change the channel to be displayed in the Digital + Calculation Display screen (“ \triangleleft ”/“ \triangleright ” keys).

(7) ENTER

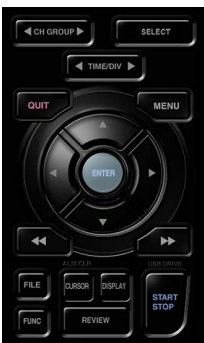

This key is primarily used for the following operations.

- To finalize setting items during menu configuration or open submenus.
- When opening the Span/Position/Trace setting menu on the “Waveform + Digital screen”.

(8) FAST REWIND/FORWARD key (KEY LOCK)

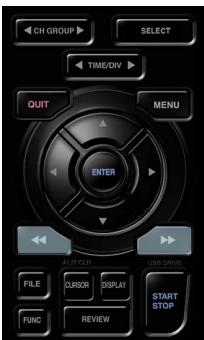

This key is primarily used for the following operations.

- To move the cursor at high speed during replay.
- To change the operation mode in the dialog.
- To set key lock (Hold down the left/right FAST REWIND/FORWARD key for at least two seconds. Press again to unlock)
A password for canceling the key lock can be specified.
Refer to “13. To cancel key lock by password” in “3.4 Setting Menus” for details.
- To change the display mode in the Digital + Calculation Display screen.



(9) START/STOP (USB Drive Mode)

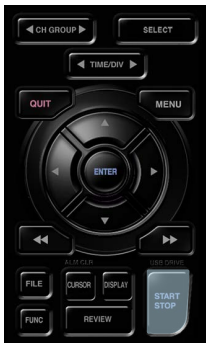

This key performs the following two operations:

<Starts/stops capture>

- When free-running, start recording.
- If recording is in progress, recording is stopped.

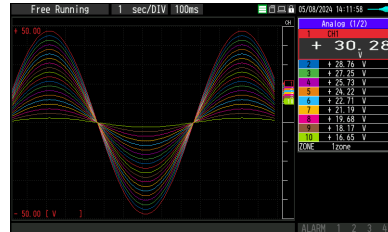

USB Drive Mode Operation Procedure

In the "USB Drive Mode", the internal memory and SD memory card can be checked on a PC as an external storage device.

When two SD memory cards are inserted into the SD CARD respectively, they are recognized as two external storage media.

Since the SD memory card is recognized as a removal disk, this mode facilitates file manipulation such as transfer and deletion.

1. Use a USB cable to connect the GL860 and a PC.
2. While pressing the GL860 [START/STOP] key, turn the power ON.
3. The external storage media is recognized by the PC and data exchange becomes possible.

* In USB Drive Mode, the display becomes as follows:



CAUTION

- To exit USB Drive Mode, turn off and on the power again.
- In USB Drive Mode, no operation including data capture and data replay is available.

(10) REVIEW

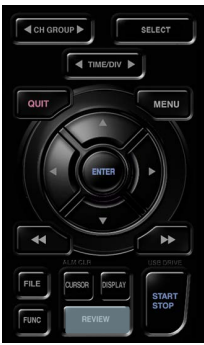

This key is used to replay captured data.

- During Free Running, captured data is replayed.
The screen used to specify the data replay source file appears; specify the file you want to replay.

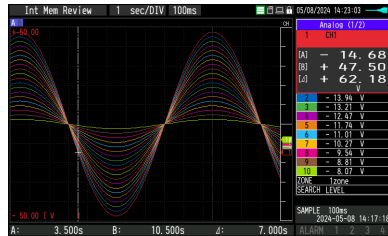

- While capturing data, recently captured data is replayed in 2-screen.

<1-screen replay display>

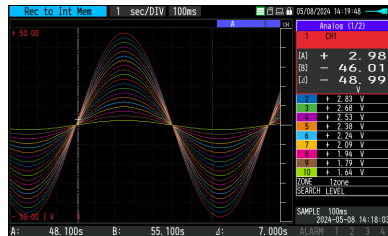
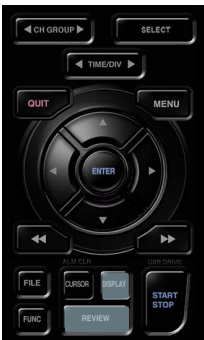

- When the [DISPLAY] key is pressed after the captured data is replayed, the captured data and current data are replayed in 2-screens consisting of the captured data screen and current data screen respectively.
Press the [DISPLAY] key again to switch the screen to a 1-screen replay display.

<2-screen replay display>

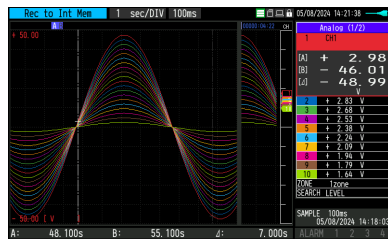

Captured data Current data

To exit the replay display, press the [QUIT] key.

CAUTION

For CSV-formatted data, only the data captured by this GL860 can be replayed.
Also, when the data captured in CSV format is replayed, the unit of the temperature data is displayed in “deg C” rather than “°C”.

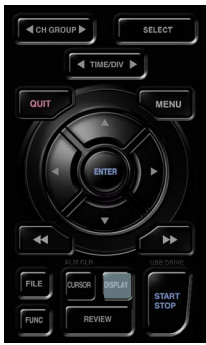
(11) DISPLAY

This key is used to switch the screen mode.

When free-running (when the recording is stopped), data capturing, and data replaying during the capture, the screen mode can be switched.

Pressing this key switches the screen display as follows:

<When free-running and data capturing>

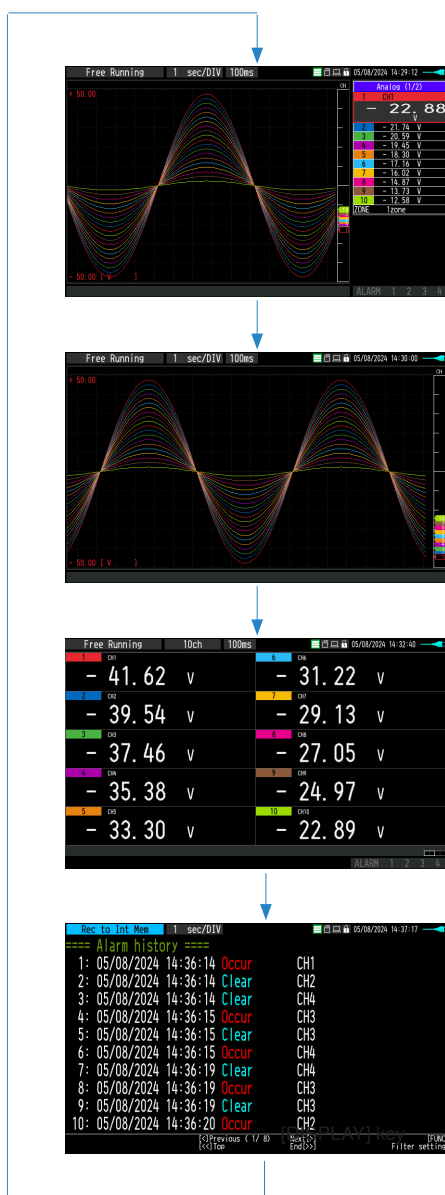

<Waveform + Digital Screen>

Displays the waveform and the digital values.

<Expanded Waveform screen>

Displays only the waveform expanded in full-screen mode.

<Digital + Calculation Display screen>

Displays digital values and two calculation results in large letters. Use the << >> FAST FORWARD keys to change the display mode. The calculation results are displayed only when switched to "All Mode".

Refer to "(8) FAST FORWARD key (KEY LOCK)"

<Alarm History screen>

When "Alarm settings" – "Alarm History" is set to enable, the Alarm History is displayed during capturing.

Refer to "Alarm History".

<Data replay during capture>

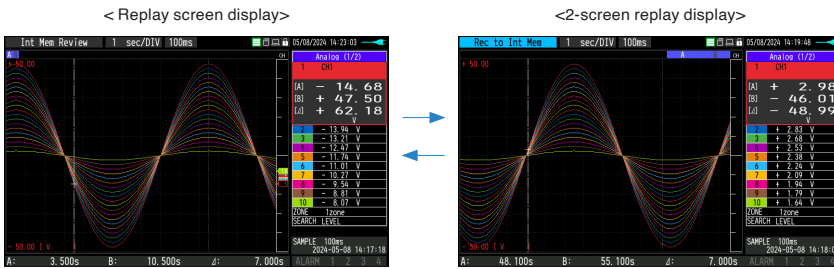

CAUTION

For CSV-formatted data, only the data captured by this GL860 can be replayed.
 Also, when the data captured in CSV format is replayed, the unit of the temperature data is displayed in “deg C” rather than “°C”.

(12) CURSOR (ALARM CLEAR)

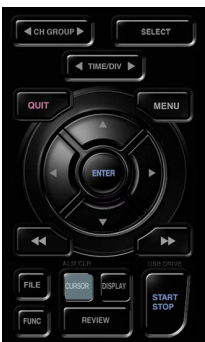

This key is used to switch between cursors A and B during replay.
 Pressing this key switches between cursor A and B.
 Refer to “(11) Data replay menu” in “3.4 Setting Menus” for details on cursor operation.

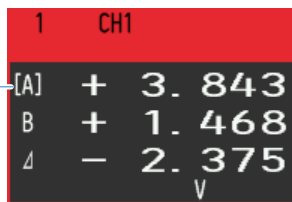
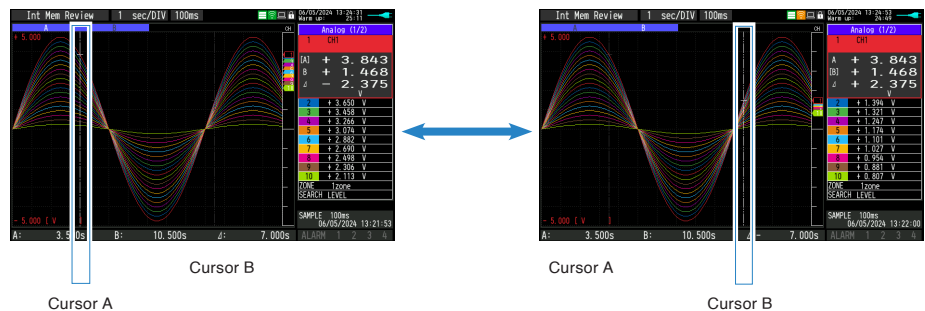

The selected cursor side is marked with [].

- When the alarm setting is “Hold generated Alarm”, the maintained alarm is cleared.

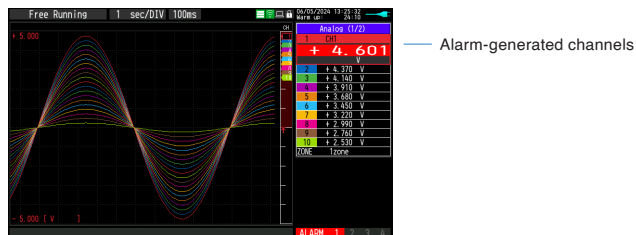

Alarm output terminal status
 • Black : Alarm is not issued
 • Red : Alarm is issued

(13) FILE

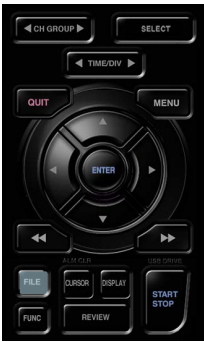

This key is used to perform the file-related operations.

- Performs the operations (copy and delete, etc.) for the internal memory and SD CARD.
- Performs the screen copy
- Saves all data or data between cursor A and cursor B during replay (can be set during replay only)
- Saves or loads the currently set condition into the USB device. (can be set during Free Running only).
- Replaces the SD CARD during data capture (Settable when capturing or backing up to the SD CARD)

The SD card cannot be replaced in the following cases:

- When recording in CSV format, if the backup function is enabled.
- When ring recording is enabled.

Refer to “(9) FILE menu” in “3.4 Setting Menus” for details on file operation.

(14) FUNC

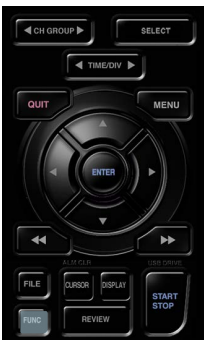

You can use a convenient function (FUNC function) that can be operated according to the current situation.

Press the “FUNC” key to display the currently operable functions at the bottom right of the screen. Select the function you want to execute with the “ Δ ”/“ ∇ ” keys and press the [ENTER] key to execute the function.

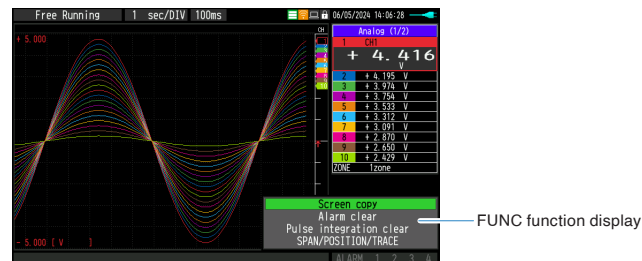

<Available FUNC function>

What you can do during free running/capturing

- Screen copy
- Alarm clear
- Pulse integration clear
- Calculation clear (while the calculation screen is displayed)
- Span/Position/Trace setting display
- Alarm History filter setting display (while the Alarm History is displayed)

What you can do during replaying

- Screen copy
- Alarm clear*1
- Pulse integration clear*1
- Span/Position/Trace setting display
- Alarm History filter setting display (while the Alarm History is displayed)
- Search next
- Search previous
- A/B cursor change
- A cursor selection
- B cursor selection
- A/B Cursor Synchronization/Unsynchronization

*1: Clears the currently occurring alarm and pulse, not the playback data.

Basic Procedures Used in Settings



The following are basic operation procedures for settings.

1. Press the [MENU] key to open each menu.
You can move between menu tabs by pressing the [MENU] key several times or by pressing the "<◀▶>" key when the cursor is on a tab.

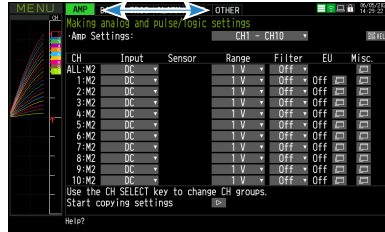

2. Use the "△▽◀▶" key to move the cursor to the items you want to set.

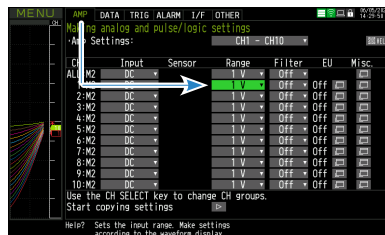

3. Press the [ENTER] key to display a list of setting values.

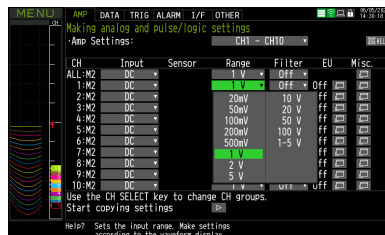

4. Use the "△▽◀▶" key to select a setting value.

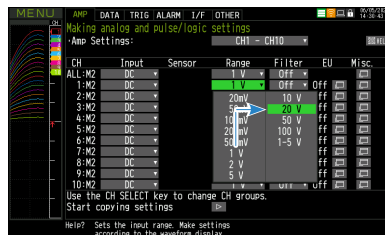

5. Press the [ENTER] key to confirm the value.

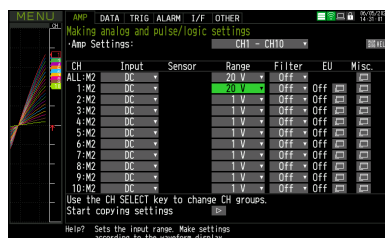

The above explanation shows the basic procedure that may be used for each setting.

The setting procedure varies depending on each setting item. Please set in accordance with the instructions displayed in the menu.

3.3 Operation Modes

You can check the system operation status in the status message display.

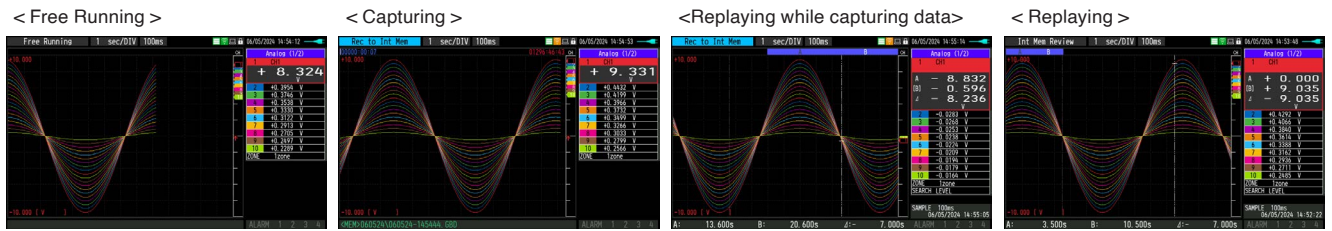

Operation	Description	Simple message display
Free Running	Startup status, or data is not being captured.	Free Running
Capturing	The data is being captured.	While capturing to internal memory or SD CARD
Replaying while capturing data	Replaying the data during capture and displaying the current waveform.	While capturing to internal memory or SD CARD
Replaying	Captured data is being replayed.	While capturing to internal memory or SD CARD

Operation status transition

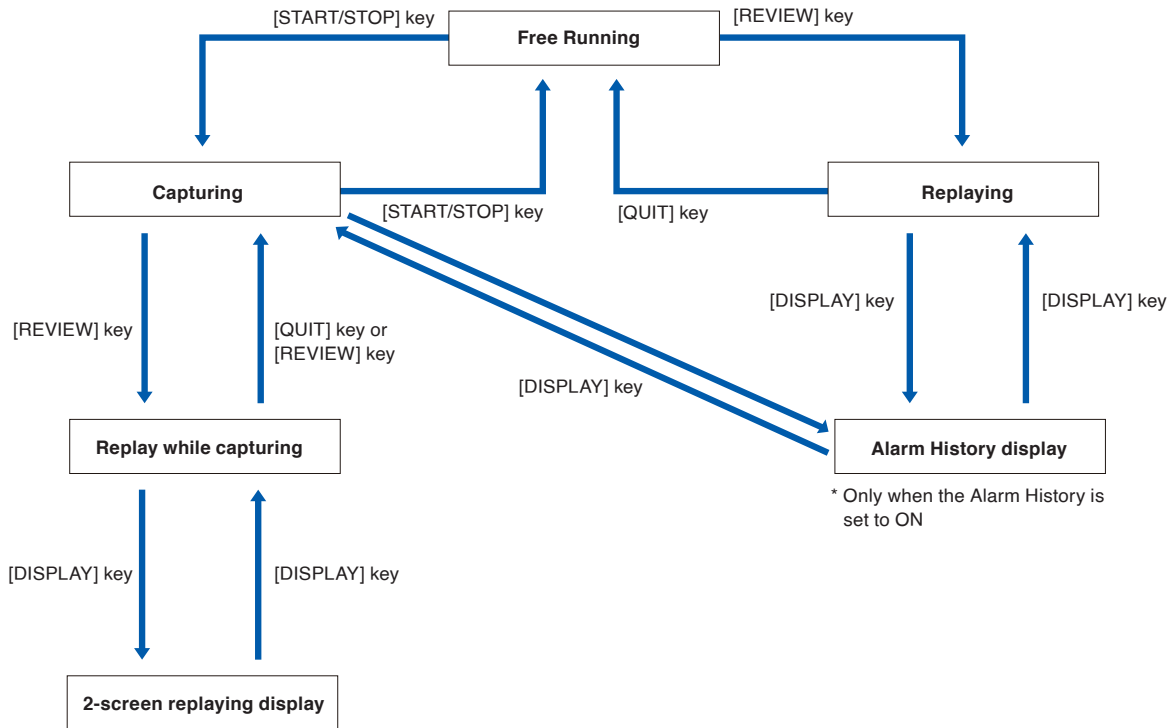

1. Free Running



In free-running, you primarily perform the settings for data capture. You can check the currently input signal in the waveform or digital value.

Main operations available during Free Running

Measurement parameters settings	The [MENU] key is used to change various setting items in configuration menus.
SPAN/POSITION/TRACE	Press the [ENTER] key to open the Span/Position/Trace settings and make settings.
Display mode	The [DISPLAY] key is used to change the display mode.
File operations	The [FILE] key is used to perform file-related operations.
Data replay	The [REVIEW] key is used to replay the captured data.
Time axis change	The [TIME/DIV] key is used to change the time axis scale.

Screen display operations

The information in the screen display is changed by switching the selected channel. The operation of screen display can be performed during free-running, capturing, and replaying.

<Display when CH1 is selected on Free running waveform + Digital screen>

The scale of the selected channel is indicated.

The selected channels are displayed with a colored frame. The selected channel can be switched by operating the “ Δ ”/“ ∇ ” keys.

The selected channel is displayed without coloration.

2. Capturing

The remaining capacity of memory
(Remaining time more than 99999 hours is displayed as “+++++.”)

Time of Capturing

Capture destination and file name

The captured data is saved in the internal memory or SD memory card during data capture. You cannot use the [MENU] key to change the setting.

Operations available during capture

SPAN/POSITION/TRACE change	Press the [ENTER] key to open the Span/Position/Trace settings and make settings.
Screen display mode switch	Used to change the screen mode with the [DISPLAY] key.
Replay while capturing	The [REVIEW] key is used to replay captured data in two windows at the same time.
Save to device	While data is replayed in two windows, the [FILE] key is used to save data to a device.
Setting check	Display the setting information with the [MENU] key.
Time axis change	Change the time axis with the [TIME/DIV] key.

3. Data replaying during capture

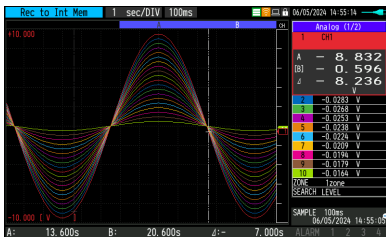

Displays the voltage at a point indicated by Cursor A or B or the selected cursor.

Displays the measurement time at a point indicated by Cursor A or B or the selected cursor.

The captured data while capturing can be replayed by pressing the [REVIEW] key.

You can switch between the 1-screen (replayed data) and 2-screens (replayed data during data capture) by pressing the [DISPLAY] key.

Use the Direction keys (<Δ>) to move the cursor and captured data to check digital values.

Main operations to replay during data capture

Operation in the menu during data replay	Use the [MENU] key to move the cursor and search data.
Cursor movement	You can switch between cursors A and B using the [CURSOR] key. The "<Δ>" or "<Δ<", ">Δ>" keys are used to move the cursors.
Save to device	The save to the device can be performed from the [FILE] key. (During capturing, you can save the captured data up to the present or the data of the section between the A and B cursors in a separate file.)
Screen copy	Copy the screen with the [FILE] key.
Switching between screen	You can switch between 1-screen and 2-screens during data replaying by pressing the [DISPLAY] key.
Time axis change	Change the time axis with the [TIME/DIV] key.

4. Captured data replaying

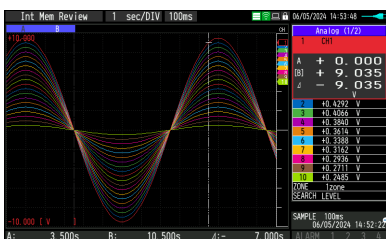

Displays the voltage at a point indicated by Cursor A or B or the selected cursor.

Displays the measurement time at a point indicated by Cursor A or B or the selected cursor.

Displays the captured data.

Main operations to replay captured data

SPAN/POSITION/TRACE replay	Press the "ENTER" key to open the [SPAN/POSI/TRACE] settings and change the settings.
Operation in the menu during data capture	Perform cursor movement and data search with the [MENU] key.
Cursor movement	You can switch between cursors A and B using the [CURSOR] key. Using the "<>" or "<<", ">>" keys, move the cursor.
Data save	Save all the data or data between cursors with the [FILE] key.
Time axis change	Change the time axis scale with the [TIME/DIV] key.
File operation	Using the [FILE] key, perform file-related operations.
Display cop	Copy the screen with the [FILE] key.
Alarm History	Display the Alarm History with the [DISPLAY] key and move the cursor to the alarm point.

CAUTION

- For CSV-formatted data, only the data captured by this GL860 can be replayed. Also, when the data captured in CSV format is replayed, the unit of the temperature data is displayed in "deg C" rather than "°C".
- Alarm History is available only when the alarm history file exists in the same folder as the data.

3.4 Setting Menus

When you press the [MENU] key during Free Running, the following menu screens appear.

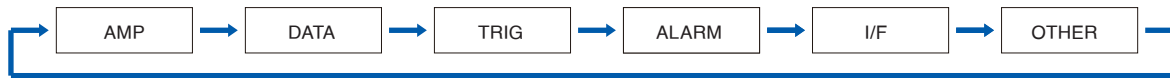

1. AMP settings

This menu is used to specify input signal-related settings.

<Analog settings>

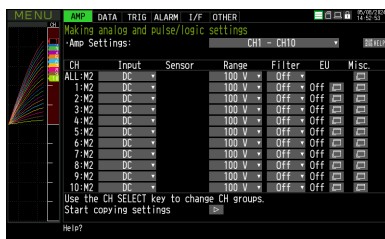

<Logic Pulse settings>



<Calculation settings>



Setting		Selections available		
Analog				
Input	Standard terminal / Screwless terminal / Withstand high-voltage high-precision terminal		Off, DC, TEMP, RH	
Standard 20CH screw terminal (B-563) Standard 20CH screwless terminal (B-563SL) Standard 30CH screwless terminal (B-563SL-30)	Range	Voltage		20·50·100·200·500mV, 1·2·5·10·20·50·100V, 1-5V
		Temperature	Sensor	Thermocouple: TC-K·TC-J·TC-T, TC-R, TC-E, TC-B, TC-S, TC-N, TC-C
			Range	100·500·2000°C
		Humidity	100% fixed	
	Filter	Off, 2, 5, 10, 20, 40		
Withstand high-voltage high-precision terminal (B-565)	Range	Voltage		20·50·100·200·500mV, 1·2·5·10·20·50·100V, 1-5V
		Temperature	Sensor	Thermocouple: TC-K·TC-J·TC-T·TC-R·TC-E·TC-B·TC-S·TC-N·TC-C Resistance bulb: Pt100·JPt100·Pt1000
			Range	100·500·2000°C
		Humidity	100% fixed	
	Filter	Off·2·5·10·20·40		
EU (Scaling settings)	Function		Off, On * When measuring the humidity, "Off" is fixed.	
	Meas. Value	Upper limit	Set numeric value	
		Lower limit	Set numeric value	
	EU output	Upper limit	Set numeric value	
		Lower limit	Set numeric value	
	Dec pt	EU output upper limit × 0.01, × 1, × 10, × 100, × 1000		
	Select	Voltage, Current, Length, Area, Volume, Velocity, Accel, Freq, Mass, Energy, Pressure, Flow, Temp, Strain, Brightness, Concentration		
	Unit	(The selections vary depending on the unit selected in the above.)		
Arbitrary unit	Enter text (Max. 8 characters)			
Misc.	Annotation text string		Enter text (Max. 31 characters)	
	Span settings	Upper limit	Set numeric value	
		Lower limit	Set numeric value	
	Waveform color setting	0 to 31 for each of red, green, blue (RGB)		
	Line Thickness Setting	1 to 8 dots		
	Trace setting	Off, On		
	Perform Auto Zero ADJ.	▷ Press the right key to execute. * This function is not available for the temperature setting.		
	Reset Auto Zero ADJ.	▷ Press the right key to execute. * This function is not available for the temperature setting.		

Setting		Selections available		
Logic/Pulse				
Mode		Off, Logic, Pulse		
Logic	Filter	Off, On		
	Misc.	Waveform color setting	0 to 31 for each of red, green, blue (RGB)	
		Trace setting	Off, On	
Pulse	Input	Off, Revolution counts, Counts, Inst.		
	Filter	Off, On		
	Slope	H, L		
	EU	Function	Off, On	
		Meas. Value	Set numeric value	
		EU output value	Set numeric value	
		Select	Voltage, Current, Length, Area, Volume, Velocity, Accel, Freq, Mass, Energy, Pressure, Flow, Temp, Strain, Brightness, Concentration	
		Unit	(The selections vary depending on the unit selected in the above.)	
		Arbitrary unit	Enter text (Max. 8 characters)	
	Misc.	Waveform color setting	0 to 31 for each of red, green, blue (RGB)	
		Line Thickness Setting	1 to 8 dots	
		Trace setting	Off, On	
Number of pulses per revolution		1 to 10000		

Setting		Selections available	
Calculation			
Calculation		Off, Calculation formula, 4-point input	
Calculation formula	Formula		{ (a × CH-X) (+, -, *, /) (b × CH-Y) + c} (/1000000, /1000, ×1, ×1000, ×1000000)
		CH-X	Calculation target CH number (Analog CH only)
		CH-Y	Calculation target CH number (Analog CH only)
		a	Numerical input
		b	Numerical input
		c	Numerical input
		Operator	+, -, *, /
		Scale	/1000000, /1000, ×1, ×1000, ×1000000
4-point input	CH-X	Calculation target CH number (Analog CH only)	
	Measured value Upper limit	Numerical input	
	Measured value Lower limit	Numerical input	
	Calculated value Upper limit	Numerical input	
	Calculated value of Upper and Lower limits	Numerical input	
	Decimal point	1.0000, 10.000, 100.00, 1000.0, 10000.	
Calculated span	Automatic adjustment execution	▷ Execute	
	Upper limit	Numerical input	
	Decimal point	1.0000, 10.000, 100.00, 1000.0, 10000.	
	Lower limit	Numerical input	
	Unit selection	Voltage, Current, Length, Area, Volume, Velocity, Accel, Freq, Mass, Energy, Pressure, Flow, Temp, Strain, Brightness, Concentration	
	Unit	(The unit to be selected depends on the measurement object above.)	
	Arbitrary unit	Character entering (up to 8 characters)	
Misc.	Annotation text string	Enter text (Max. 31 characters)	
	Waveform color setting	0 to 31 for each of red, green, blue (RGB)	
	Line thickness setting	1 to 8 dots	
	Trace settings	Off, On	

Switching displays

Switching between Analog, Logic/Pulse and Calculation is as follows.

Select the channel to be displayed from the amplifier. For analog channels, the items displayed change depending on the number of terminals connected.

Select	Target Channel
CHx - CHy	Displays the analog channel.
Logic/ Pulse	Displays the Logic/ Pulse.
CALCx - CALCy	Displays the calculation channel.

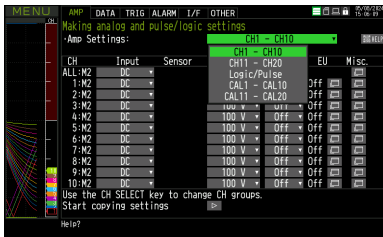

Analog settings

Specifies the conditions for analog signals.

Checkpoint

When you use CH ALL to set an input, range and filter, all channels are set to the same values if the input is the same. Range is set only for the same input channels. However, the range of a channel is not changed if its EU (scaling) is set to On.

Span All Settings is set only for the same range channels.

* If the first channel in a channel group (CH1 if CHs 1 to 10 are displayed) has an input that is set to Off, the input of CH ALL is set to Off.

1-1. Input

This is used to select the input condition

Selection item	Description
Off	Input signal measurement is disabled. No waveform or digital value is displayed.
DC	Used for measuring direct-current voltage.
TEMP	Used for measuring temperature.
RH	Used for measuring humidity with the humidity sensor B-530. In this case, the voltage range will become 1V, and the EU settings will not be available.

*Depending on the recording environment, it may take a long time to write files during recording. If writing takes a long time, reduce the number of channels or adjust the sampling interval.

1-2. Sensor

This is used to select the type of thermocouple to be connected when the temperature is input.

Terminal Unit	Selection item	Description
Standard 20CH screw terminal (B-563) Standard 20CH screwless terminal (B-563SL) Standard 30CH screwless terminal (B-563SL-30)	Sensor	Thermocouple: TC-K·TC-J·TC-T·TC-R·TC-E·TC-B·TC-S·TC-N·TC-C
Withstand high-voltage high-precision terminal (B-565)		Thermocouple: TC-K·TC-J·TC-T·TC-R·TC-E·TC-B·TC-S·TC-N·TC-C Resistance bulb: Pt100·JPt100·Pt1000

1-3. Range

This is used to select the range of measurement.

Input item	Description
DC	20, 50, 100, 200, 500mV; 1, 2, 5, 10, 20, 50, 100V 1-5V
TEMP	2000, 500, 100°C * The resolution varies depending on the range.
RH	No selection available

Available SPAN Settings

<Voltage Ranges>

Range	Maximum SPAN	Minimum SPAN	Minimum Resolution
20mV	-22.000 to +22.000mV	0.200mV	0.001mV
50mV	-55.00 to +55.00mV	0.50mV	0.01mV
100mV	-110.00 to +110.00mV	1.00mV	0.01mV
200mV	-220.00 to +220.00mV	2.00mV	0.01mV
500mV	-550.0 to +550.0mV	5.0mV	0.1mV
1V	-1.1000 to +1.1000V	0.0100V	0.0001V
2V	-2.2000 to +2.2000V	0.0200V	0.0001V
5V	-5.500 to +5.500V	0.050V	0.001V
10V	-11.000 to +11.000V	0.100V	0.001V
20V	-22.000 to +22.000V	0.200V	0.001V
50V	-55.00 to +55.00V	0.50V	0.01V
100V	-110.00 to +110.00V	1.000V	0.01V
1-5V	-5.500 to +5.500V	0.050V	0.001V

<Temperature Ranges>

Type	Humidity Range	Resolution	Measurement range
R / S	100°C F.S.	0.01°C	0 ~ 100°C
	500°C F.S.	0.05°C	0 ~ 500°C
	2000°C F.S.	0.1°C	R: 0 ~ 1600°C S: 0 ~ 1760°C
B	500°C F.S.	0.05°C	400 ~ 500°C
	2000°C F.S.	0.1°C	500 ~ 1820°C
K / E / T / J / N	100°C F.S.	0.01°C	-100 ~ 100°C
	500°C F.S.	0.05°C	K / E / J / N: -200 ~ 500°C T: -200 ~ 400°C
	2000°C F.S.	0.1°C	K: -200 ~ 1370°C
			E: -200 ~ 800°C
			T: -200 ~ 400°C
			J: -200 ~ 1100°C N: -200 ~ 2000°C
C(W)	100°C F.S.	0.01°C	0 ~ 100°C
	500°C F.S.	0.05°C	0 ~ 500°C
	2000°C F.S.	0.1°C	0 ~ 2000°C
Pt	100°C F.S.	0.01°C	-100 ~ 100°C
	500°C F.S.	0.05°C	-200 ~ 500°C
	2000°C F.S.	0.1°C	Pt100: -200 ~ 850°C JPt100 / Pt1000: -200 ~ 500°C

<Humidity Range>

Range	Maximum SPAN	Minimum SPAN (p-p)	Minimum Resolution
100%	0 to +110%	1.0%	0.1%

1-4. Filter

Selects the range to be measured.

Selection item	Description
Off	No moving average is calculated.
2	A moving average is calculated 2 times per sampling interval.
5	A moving average is calculated 5 times per sampling interval.
10	A moving average is calculated 10 times per sampling interval.
20	A moving average is calculated 20 times per sampling interval.
40	A moving average is calculated 40 times per sampling interval.

<Filter processing>

Filter processing performed on the GL860 is the moving average shown in the following figure.

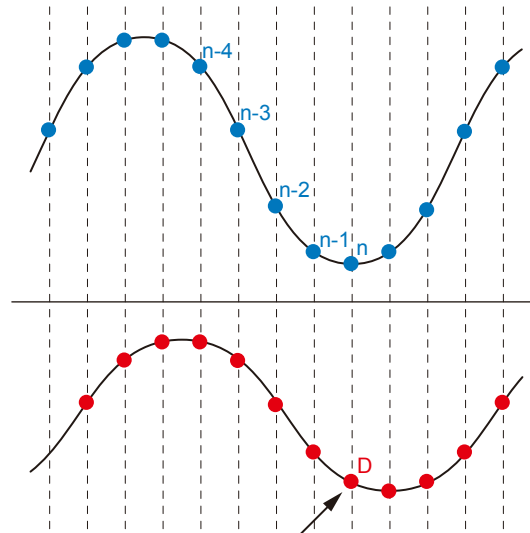

If the filter setting is 5,
The moving average is " $D = ((n-4) + (n-3) + (n-2) + (n-1) + n) \div 5$ ".

Checkpoint

If the sample interval exceeds 30 seconds, the average value of data obtained in a sub-sample (30 seconds) is used.

1-5. EU (Scaling settings)

This is used to convert the measured signals to other units.

<For voltage input>

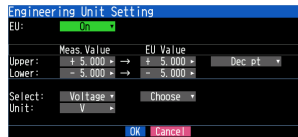

<For temperature input>

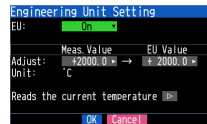

Setting	Description
EU Function	Sets the scaling function to ON or OFF.
Meas. Value (Upper/Lower)	Sets the upper and lower limits of values to be converted. * For temperature input, there is no distinction between upper and lower limits. See the setting examples shown below for details.
EU Output Value (Upper/Lower)	Sets the upper/lower limit output values after conversion. * For temperature input, there is no distinction between upper and lower limits. See the setting examples shown below for details.
Dec pt	Sets the decimal point position for an EU output value.
Select	Selects a specific engineering unit classification. (The following are available.) Voltage, Current, Length, Area, Volume, Velocity, Accel, Freq, Mass, Energy, Pressure, Flow, Temp, Strain, Brightness, Concentration
Unit	Selects a unit to be used after conversion. A unit displayed in this field belongs to the classification selected in "Select." To set a unit not displayed in this field, set arbitrary text in "Arbitrary unit." The setting selected in this field is displayed in "Arbitrary unit."
Arbitrary Unit	Sets a unit to be used after conversion. Arbitrary text consisting of alphabetical characters and numerical values can be set as a unit. (For the character input, refer to "10. Text input" in "3.4 Setting Menus".) When "Select Unit" or "Unit" is specified, it is reflected here.
Reads the current temperature measurement value	Substitutes the current measurement value into Measurement value and EU output value. * The value is not substituted when burnout occurs or the scale is exceeded.

Checkpoint

- If a message window opens, follow the instruction in the message to change the setting value.
- The Scaling function performs calculation using a ratio of the Meas. Value and EU Output Value settings.
- The digital display shows “++++/-----” when the converted value cannot be processed by the GL860.
- The span may be changed depending on the Scaling settings.
- For temperature input, the offset setting for an input value is used.

Setting example: For voltage input

	Meas. Value	EU Output Value	Dec pt	Choose
Upper limit	+5.000	+20.00	+ xx.xx	rpm
Lower limit	-5.000	-20.00		

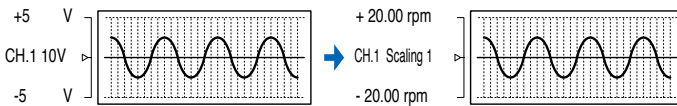

Setting example: For temperature input

Meas. Value	EU Output Value
22.0°C	25.0°C

3°C is always added to the measurement value

1-6. Misc.

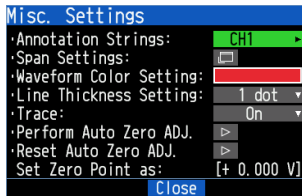

Setting object	Setting	Description
Voltage, humidity	Annotation Settings	Set the annotation (comment) displayed in the CH.
	Span Settings	Set the upper and lower limits of values of a span in which a waveform should be displayed.
	Waveform Color Setting	0 to 31 for each of red, green, blue (RGB)
	Line Thickness Setting	Setting 1 to 8 dots
	Trace	This is used to set the waveform display.
	Perform Auto Zero ADJ.	The current input voltage is calculated as a zero-point voltage value. The automatic adjustable voltage range is within $\pm 10\%$ of a set range.
	Reset Auto Zero ADJ.	Reset the zero-point voltage value. * When the temperature is set, this function is not available.
Set Zero Point as:	The zero-point voltage value is displayed. * When the temperature is set, this function is not available.	

Logic and Pulse settings

Makes settings related to digital input.

<For Pulse>



<For Logic>



1-7. Logic / Pulse

This is used to select the processing method for digital input.

Selection item	Description
Off	Digital input measurement is disabled.
Logic	Digital input is processed as logic signals.
Pulse	Digital input is processed as pulse signals.

1-8. Input

This is used to set the pulse measurement mode. This setting is available only if Pulse is selected in "1-7. Logic / Pulse".

Selection item	Description
Off	Pulse input measurement is disabled.
Revol.	The number of pulses per sample interval is counted and converted to the number of revolutions per minute.
Counts	Captures the cumulative number of pulses for each sampling interval from the start of measurement.
Inst.	Captures the number of pulses for each sampling interval.

*Depending on the recording environment, it may take a long time to write files during recording. If writing takes a long time, reduce the number of channels or adjust the sampling interval.

1-9. Filter

This is used to set the filter for input.

Selection item	Description
Off	Disables hardware filter.
On	Enables hardware filter. It is effective in a noisy environment. The filter is approximately 30 Hz (-3 dB).

1.10 Slope

This is used to set the slope (direction) to count the number of pulses. This setting is available only if Pulse is selected in "1-7.Mode".

Selection item	Description
H	Counts the rising edges of pulses.
L	Counts the falling edges of pulses.

1-11. EU (Scaling settings)

This is used to convert the measured signals to other units. This setting is available only if Pulse is selected in "1-7.Logic / Pulse".

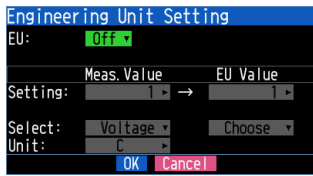

Setting	Description
EU Function	Sets the scaling function to ON or OFF.
Meas. Value	Sets a value to be converted.
EU Value	Sets an output value after conversion.
Select	Selects a specific engineering unit classification.(The following are available.) Voltage, Current, Length, Area, Volume, Velocity, Accel, Freq, Mass, Energy, Pressure, Flow, Temp, Strain, Brightness, Concentration
Unit	Selects a unit to be used after conversion. A unit displayed in this field belongs to the classification selected in "Select." To set a unit not displayed in this field, set arbitrary text in "Arbitrary unit." The setting selected in this field is displayed in "Arbitrary unit."
Arbitrary Unit	Sets a unit to be used after conversion. Arbitrary text consisting of alphabetical characters and numerical values can be set as a unit. (For the character input, refer to "10. Text input" in "3.4 Setting Menus".) When "Select Unit" or "Unit" is specified, it is reflected here. When "Select" or "Unit" is used, the setting is reflected in this field.

Checkpoint

- If a message window opens, follow the instruction in the message to change the setting value.
- The Scaling function performs calculation using a ratio of the Meas. Value and EU Output Value settings.
- The digital display shows “++++/-----” when the converted value cannot be processed by the GL860.
- The span may be varied depending on the scaling settings.

Setting example

Meas. Value	EU Output Value	Dec pt	Choose
1000	800	+ xx.xx	rpm
0	200		

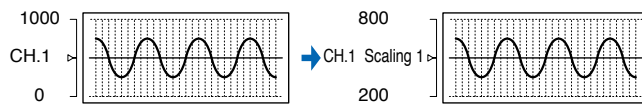

1-12. Misc.

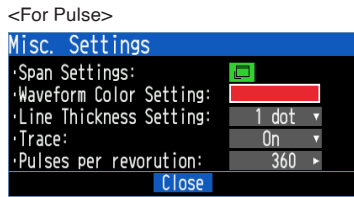

Setting	Description
Waveform Color Setting	0 to 31 for each of red, green, blue (RGB)
Line Thickness Setting	1 to 8 dots
Trace	This is used to set the waveform display.
Pulses per revolution	1 to 10000 When setting the pulse input to the number of revolutions, set the number of pulses per revolution. As the number of pulses per revolution set here is 1 revolution, the number of revolutions per minute (RPM) is calculated. For example, if "100" is set, 1 rotation is judged when 100 pulses have been input. <Calculation formula> Number of revolutions (RPM) = Pulse input frequency ÷ Number of pulses per revolution x 60 (1 minute) <Example> Number of pulses per revolution: 100 (1 rotation is judged when 100 pulses have been input.) Pulse input: 1000 Hz (1000 pulses per sec.) Number of revolutions: 600 RPM (600 revolutions per 1 minute)

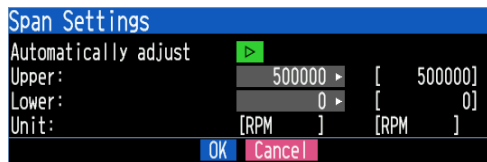

Selection item	Description
Automatically adjustment	Automatically adjust the span value based on the displayed data.
Upper limit	Set the span upper limit.
Lower limit	Set the span lower limit.
Unit	Set the unit.

<Regarding automatic span adjustment>

The target of automatic adjustment is the range of the waveform displayed on the screen when automatic adjustment is executed.

Automatic adjustment does not follow continuously. The span is determined by the data on the screen at the moment when automatic adjustment is executed.

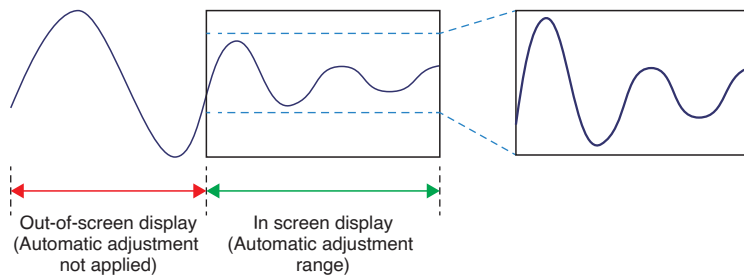

Calculation settings

1-13. Calculation

Make settings related to calculation.

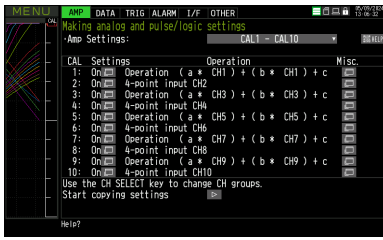

Setting	Description
Setting	Off, On (when inter-CH Op. setting is a formula or 4-point input)
Misc.	Set annotation, waveform color, line thickness and trace.

<Calculation Off settings>

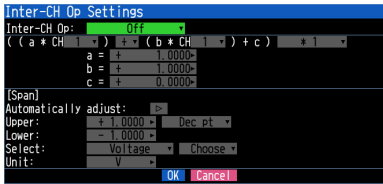

<Calculation formula settings>

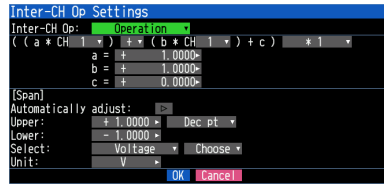

<4-point input settings>

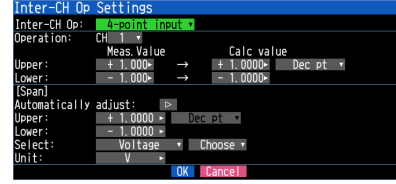

Calculation formula settings

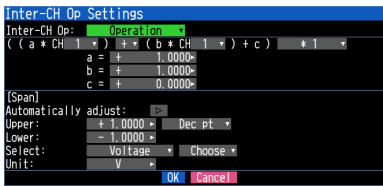

Setting	Description								
Inter-CH Op setting function	Off, calculation formula, 4-point input Select the setting method for Inter-CH Op. CHs set here as calculation formula/4-point input is marked with a calculation mark on the digital display, etc., as shown below. <div style="text-align: center;"> Calculation mark  </div> <ul style="list-style-type: none"> *In the case of a 5ms sampling interval, the maximum number of usable calculation channels is 5. *In the case of a 10ms sampling interval, the maximum number of usable calculation channels is 10. *If the sampling interval is slower than 20 ms, the maximum number of usable calculation channels is 20. 								
CH-X	Select CH to calculate.								
Operator	Select the operator +, -, *, / to calculate.								
CH-Y	Select CH to calculate.								
Scaling*1	/1000000, /1000, x1, x1000, x1000000 Set the scaling factor for a calculation result. <Example> <table border="1" style="width: 100%; margin-top: 5px;"> <tr> <td>In the case of calculation result = 0.001</td> <td>In the case of calculation result = 1000</td> </tr> <tr> <td>Calculation result x 1 = 0.001</td> <td>Calculation result x 1 = 1000</td> </tr> <tr> <td>Calculation result x 1000 = 1</td> <td>Calculation result / 1000 = 1</td> </tr> <tr> <td>Calculation result x 1000000 = 1000</td> <td>Calculation result / 1000000 = 0.001</td> </tr> </table>	In the case of calculation result = 0.001	In the case of calculation result = 1000	Calculation result x 1 = 0.001	Calculation result x 1 = 1000	Calculation result x 1000 = 1	Calculation result / 1000 = 1	Calculation result x 1000000 = 1000	Calculation result / 1000000 = 0.001
In the case of calculation result = 0.001	In the case of calculation result = 1000								
Calculation result x 1 = 0.001	Calculation result x 1 = 1000								
Calculation result x 1000 = 1	Calculation result / 1000 = 1								
Calculation result x 1000000 = 1000	Calculation result / 1000000 = 0.001								
a	Set the coefficient of CH-X.								

Setting	Description
b	Set the coefficient of CH-Y.
c	Set the offset value of the calculated value.
Auto adjustment	Adjust the span range based on the displayed measurement value.
Upper limit	Set the upper span value to display the waveform. The set value is the value for the calculation result.
Decimal point	1.0000, 10.000, 100.00, 1000.0, 10000. Select the decimal point of the calculated value. * This is the same as the decimal point used for scaling.
Lower limit	Set the lower span value to display the waveform. The set value is the value for the calculation result.
Unit selection	Select the unit that indicates the calculation results. Voltage, Current, Length, Area, Volume, Velocity, Accel, Freq, Mass, Energy, Pressure, Flow, Temp, Strain, Brightness, Concentration
Unit	Select the unit after conversion. The unit displayed here is the unit selected in the "Unit selection". When using the unit not displayed here, set any character in the "Arbitrary unit". Also, the unit set here is displayed in the "Arbitrary unit".
Arbitrary unit	Set a unit to be used after conversion. Arbitrary text consisting of alphabetical characters and numerical values can be set as a unit. (For the character entering, refer to "10. Text input" in "3.4 Setting Menus".) When "Unit selection" or "Unit" is specified, it is reflected here.

<Calculation formula>

The calculation formula is as follows.

Calculated data = $\{(a * CH-X) [+|-|*|/]\} (b * CH-Y) + c\} * \text{<Scaling>}$

By adjusting a, b and c, it is possible to support various Calculation formulas.

Example of settings

Calculation formula	CH-X	CH-Y	a	b	c	Operator	Remarks
CH1+CH2	1	2	1.0000	1.0000	0.0000	+	Inter-CH Op of an old model
3.0 * CH5+100	5	Disregard	3.0000	0.0000	100.0000	Disregard	Unary operation is possible by setting b to 0
$(2.5 * CH2)/(2.0 * CH3) - 20$	2	3	2.5000	2.0000	-20.0000	/	Use all functions

<Scaling>

Scaling adjusts the unit of the calculation result.

For example, if the calculation result is "V" and you want the unit to be "mV", set the scaling to "*1000".

4-point input settings

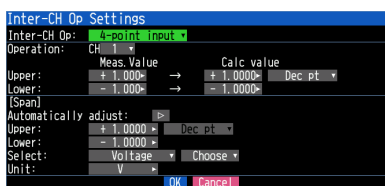

Setting	Description
CH-Z	Select the CH number to be calculated.
The upper limit of a measured value	Set the upper limit of the measured value.
The upper limit of a calculated value	Set the upper limit of the calculated value.
Decimal point	1.0000, 10.000, 100.00, 1000.0, 10000. Select the decimal point of the calculated value. * This is the same as the decimal point used for scaling.
The lower limit of a measured value	Set the lower limit of the measured value.
The lower limit of a calculated value	Set the lower limit of the calculated value.
Auto adjustment	Adjust the span range based on the displayed measurement value.

Setting	Description
Upper limit	Set the upper span value to display the waveform. The set value is the value for the calculation result.
Lower limit	Set the lower span value to display the waveform. The set value is the value for the calculation result.
Unit selection	Select the unit for displaying the calculation result. Voltage, Current, Length, Area, Volume, Velocity, Accel, Freq, Mass, Energy, Pressure, Flow, Temp, Strain, Brightness, Concentration
Unit	Select the unit after conversion. The unit displayed here is the unit selected in the "Unit selection". When using the unit not displayed here, set any character in the "Arbitrary unit". Also, the unit set here is displayed in the "Arbitrary unit".
Arbitrary unit	Set a unit to be used after conversion. Arbitrary text consisting of alphabetical characters and numerical values can be set as a unit. (For the character entering, refer to "10. Text input" in "3.4 Setting Menus".) When "Unit selection" or "Unit" is specified, it is reflected in here.

<Example> CALC1 4-point input settings
Calculation target CH3

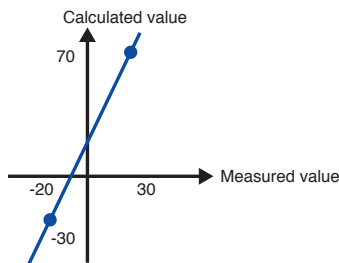

The calculation formula is $CALC1 = 2 \times CH3 + 10$.

	Measured value	Calculated value
Upper limit	30.0	70.00
Lower limit	-20.0	-30.00

Checkpoint

The calculation result is displayed in volts.
When calculating 100mV + 100mV, the calculation result is 0.2.
When you want to display 200mV, use scaling.
For 4-point input, if the source CH is in the mV range, the calculation result will be in mV units.

Misc.

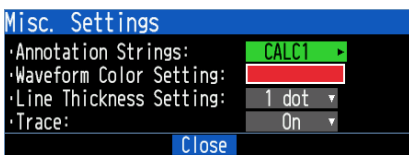

Setting object	Setting	Description
Calculation settings	Annotation Settings	Set the annotation (comment) displayed in the CH.
	Waveform Color Setting	0 to 31 for each of red, green, blue (RGB)
	Line Thickness Setting	Setting 1 to 8 dots
	Trace	This is used to set the waveform display

Valid range of calculation

Valid calculation results can be up to 5 digits. If the valid range is exceeded, "++++++" or "-----" will be displayed.
The upper and lower limits are different depending on the decimal point position setting.

Decimal point position	Max	Min
Four decimal places	+9.9999	-9.9999
Three decimal places	+99.999	-99.999
Two decimal places	+999.99	-999.99
One decimal place	+9999.9	-9999.9
Five-digit integer	+99999.	-99999.

If the calculation result is outside the valid range, change the decimal point position.

Copy settings

Copy the AMP settings of the specified CH to any CH.

(1)-14 Copy Contents

Item		Supplement
Analog CH	Input	
	Sensor	
	Range	
	Filter	
	EU	
	Span	
	Trace	
	Trigger	Select whether to copy or not in the copy options. Level value only.
	Alarm	Select whether to copy or not in the copy options. Level value and output number.
Logic	Filter	
	Trace	
	Trigger	Select whether to copy or not in the copy options. Level value only.
	Alarm	Select whether to copy or not in the copy options. Level value and output number.
Pulse	Input	
	Filter	
	Slope	
	EU	
	Span	
	Trace	
	Pulses per revolution	
	Trigger	Select whether to copy or not in the copy options. Level value only.
	Alarm	Select whether to copy or not in the copy options. Level value and output number.
Calculation	Calculation	Off, Calculation formula, 4-point input
	Calculation formula CH-X,Y	For setting the calculation formula
	Coefficient a,b/Constant c	For setting the calculation formula
	Operator	For setting the calculation formula
	Scaling	For setting the calculation formula
	CH-X	For 4-point input
	Measured value Upper limit/Lower limit	For 4-point input
	Calculated value Upper limit/Lower limit	For 4-point input
	Decimal point	For 4-point input
	Span Upper limit/Lower limit/Decimal point	The decimal point is the same as when entering 4 points.
	Unit	
	Trace	
	Trigger	Select whether to copy or not in the copy options. Level value only.
	Alarm	Select whether to copy or not in the copy options. Level value and output number.

Checkpoint

- Pt100, JPt100, and Pt1000 settings cannot be copied to amplifiers that do not support RTDs.
- Alarm and trigger settings can be copied if they are enabled in the custom menu.

(1)-15 How to specify copy channel

< Operation Procedure >

Copy settings from any CH to the specified destination CH.

1. Start copying settings on the “AMP” tab.

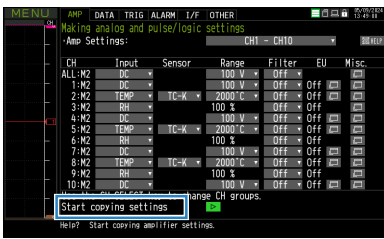

2. Select the source channel. The source channel will be marked with a “*” mark.

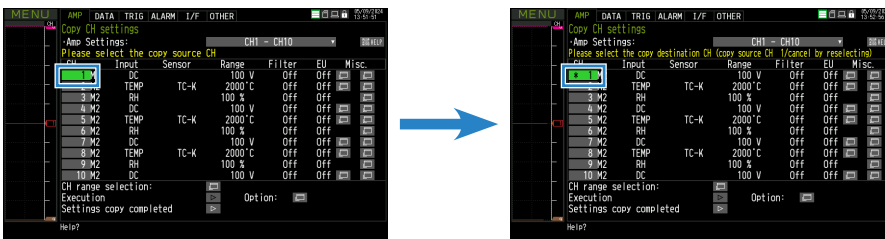

Checkpoint

Selecting the same channel again will cancel the source channel.

3. Specify the copy destination. The copy destination CH will be marked with a “>” mark. You can specify multiple copy destinations, and specifying a CH again will remove it from the copy destination.

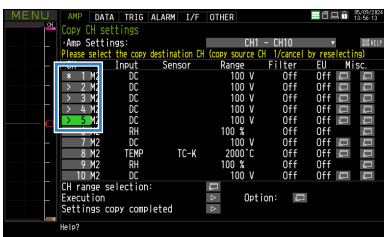

4. Execute the copy.



- When the settings are copied, the copy mode ends.

Checkpoint

If you change the type of the copy source CH (Analog, Logic/Pulse, or Math), the copy destination selection that was previously selected will be cleared.

(1)-16 How to specify the copy channel range

- Start copying the AMP tab.

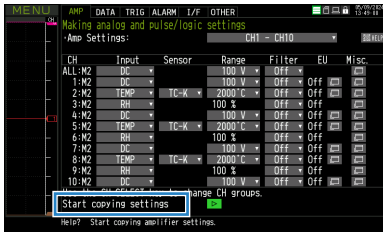

- Open the CH range selection.

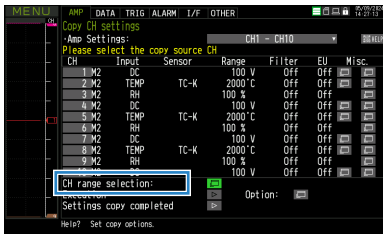

- Set the range of source and destination CHs, then press "OK."

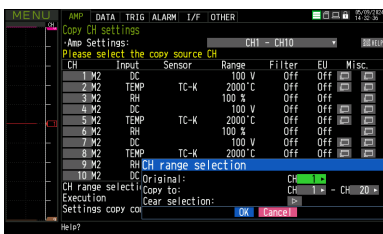

Checkpoint

If you clear the selection, the currently selected CH will be cleared and you will return to the previous screen.

- Verify that the source CH has an "*" mark and the destination CH has an ">" mark and click Execute.

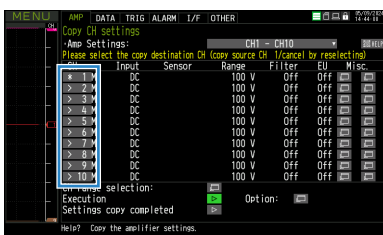

- The specified CH will be copied.

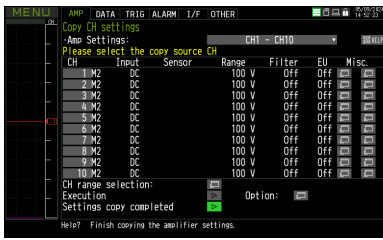

- When the settings are copied, the copy mode ends.

(1)-17 Copy Options

In addition to the AMP settings, you can also choose whether to copy the trigger (level value) and alarm settings at the same time with the copy function.

The selection is made in the “Options” section.

- Select an option item.

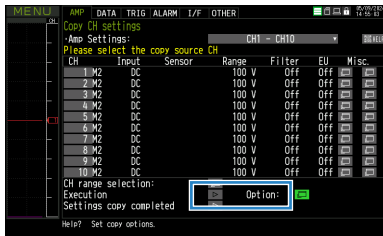

- Select ON if you want to copy the trigger (level value) and alarm settings, or select OFF if you do not want to copy them.

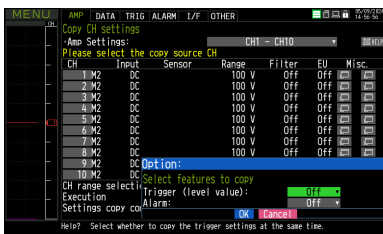

Checkpoint

If the trigger or alarm function is set to OFF in the custom menu, the corresponding function will not be displayed in the options submenu.

If both are OFF, the options menu itself will not be displayed.

2. DATA settings

This is used to specify capture-related items and calculations.

<Sampling>

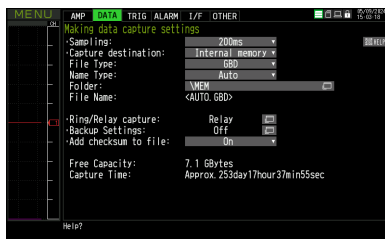

<Sampling (at external input)>

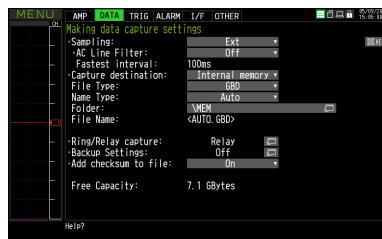

Setting	Selections available
Sampling	110, 20, 50, 100, 125, 200, 250, 500 ms, 1, 2, 5, 10, 20, 30s, 1, 2, 5, 10, 20, 30 min, 1h, Ext. * Available sampling intervals vary depending on the input settings and the number of channels to be used. * Refer to “2-1. Sampling Interval” for details. * For details on external sampling (external), refer to “2-2. External sampling”.
AC Line Filter	On, Off * Displayed when the sampling interval is external. * For details on the AC line filter, refer to “2-3. AC line filter”.
Capturing destination	Internal memory, SD CARD
File Type	GBD, CSV Set the file format used to save data. GBD: Creating a data file in Graphtec's proprietary binary format * It is not possible to change the data. CSV: Creating a data file in text format
Name Type	Auto, Arbitrary, Sequential number Set how a data file should be named. Auto: Automatically supplies the file name. Example: 20230201-123456_UG.GBD Number part : File creation date * The file is created on February 1, 2023, 12:34:56 in this example. Arbitrary: Data is captured in a file with an entered file name. Sequential number: A file is created with an arbitrary file name that has been entered, followed by a sequential number. Example: If the file name is “TEST” • First file: TEST_SER1.GBD • Second file: TEST_SER2.GBD • Third file: TEST_SER3.GBD * If the same file name already exists, _CP* is added to the end of a file name to prevent overwriting. The asterisk (*) represents a number. Example: TEST_CP1.GBD
Folder	Capturing destination: Internal memory, SD CARD Folder: Character entering (when the naming method is Auto) * For details on the folder, refer to “2-4 Capturing destination file name”.
File Name	File: Character entering (when the naming method is Arbitrary, Sequential number) * For details on the file, refer to “2-4 Capturing destination file name”.
Ring/Relay capture	Off, Ring, Relay
Ring capture	Number of capturing points
Relay capture	Relay mode (capacity/time), Internal memory/SD relay (Off, On)
Backup	Backup Interval
Backup Interval	Off, 1, 2, 6, 12, 24 hours, Each file *Selection of individual files is possible when “Files recorded when the backup is successful” in “FTP client settings” is set to “Delete.”
Backup Destination	Internal memory, SD CARD, FTP
Save Folder	Folder name
Data corruption check	Off, On

2-1. Sampling interval

This is used to set the sampling interval for data capture.

The table below shows the number of measuring channels*1 and sampling interval values that can be set. If data fluctuate due to noise, set the sampling interval to a value that enables the digital filter function.

Number of Measuring Channels*1	Allowed Sampling Interval	Sampling Interval which enables Digital Filter *3
1CH	5ms or slower *2	50ms or slower
2CH	10ms or slower *2	125ms or slower
3 to 4CH	20ms or slower *2	250ms or slower
5CH	50ms or slower *2	250ms or slower
6 to 10CH	50ms or slower *2	500ms or slower
11 to 20CH	100ms or slower	1s or slower
21 to 40CH	200ms or slower	2s or slower
41 to 50CH	250ms or slower	2s or slower
51 to 100CH	500ms or slower	5s or slower
101 to 200CH	1s or slower	10s or slower

*1: The number of measurement channels is the number of channels whose input settings for the standard screw terminal, Withstand high-voltage high-precision terminal, or screwless terminal are set to anything other than OFF.

*2: When the temperature setting is performed in 5, 10, 20 and 50 ms sampling intervals, the data capture cannot be performed.

*3: Depending on the recording environment, it may take a long time to write files during recording. If writing takes a long time, reduce the number of channels or adjust the sampling interval.

Checkpoint

- When using the digital filter, the AC power frequency to be used must be set accurately. Refer to “6-3-2. AC Line cycle” described later to set it correctly.
- The number of calculation channels that can be turned ON is limited by the sampling interval.

Sampling	Number of configurable calculation channels
5ms	Up to 5CH
10ms	Up to 10CH
20ms ~	Up to 20CH

2-2. External sampling

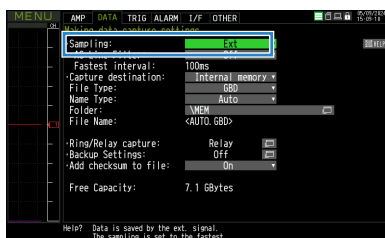

This is used to enable/disable or disable external sampling.

When the external sampling function is enabled, data is captured at the shortest intervals and retained temporarily.

This retained data is updated at the shortest intervals.

On receiving an external sampling pulse, the retained data is written to the internal memory or SD memory card. (See the following figure.)

Therefore, the maximum error in time between the actually captured data and the external sampling pulse is the same as the shortest interval.

For the fastest interval, refer to "2-3. AC line filter" below.

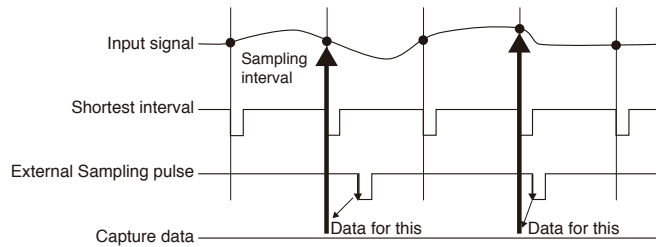

Checkpoint

- If the external sampling function is On, the external input cannot be selected for the trigger setting. If the external input has already been set, the trigger will be set to Off.
- When you measure signals with high noise levels, set the AC line filter described in the next section to On.
- When the fastest sampling is 5ms, the maximum external sampling input is 100Hz.

2-3. AC line filter

Sets whether to enable or disable the AC line filter when external sampling is enabled.

Enable this setting to enable the digital filter. When you use external sampling and measure signals with high noise levels, set the AC line filter to On.

Also, the fastest interval is displayed in the setting.



The shortest interval is as shown in the following table:

Number of Measuring Channels *1	Shortest interval	
	AC line filter (Digital filter) OFF	AC line filter (Digital filter) ON
1CH	5ms	200ms
2CH	10ms	500ms
3 ~ 4CH	20ms	1s
5CH	50ms	1s
6 ~ 10CH	50ms	1s
11 ~ 20CH	100ms	2s
21 ~ 50CH	200ms	5s
51 ~ 100CH	500ms	10s
101 ~ 200CH	1s	20s

*1 The number of measurement channels is the number of channels whose input settings for the standard screw terminal, Withstand high-voltage high-precision terminal, or screwless terminal are set to anything other than OFF.

2-4. Captured data file name

This is used to select the name of a file or folder to which you want to save capture data.

<If the naming method is Auto>

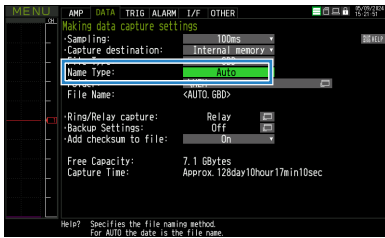

<If the naming method is Arbitrary>

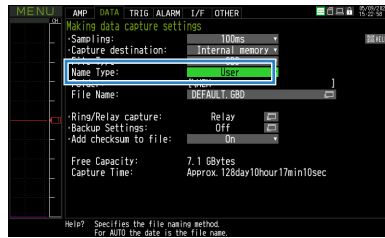

<If the naming method is Sequential>

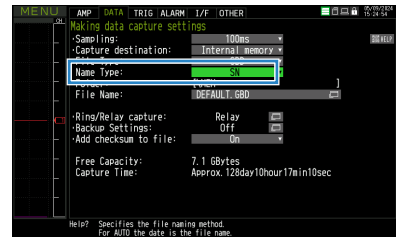

Setting	Description
Folder	Specify the capturing destination (or save destination) folder. For details, refer to "9. File dialog".
File	Specify the capturing destination (or save destination) file. For details, refer to "9. File dialog".

CAUTION

The file should be saved in the folder you created. When the data files are continued to be saved in the root folder, the data file may be not saved regardless of the memory remaining capacity due to the limitations of the file system.

Checkpoint

Changing the sampling interval, capture destination, number of measuring channels (number of channels for which the input is not Off), etc. will change the Capture Space and Capture Time on the screen.

If find that the measurement time exceeds the Capture Time, take one of the following measures:

- Change the sampling interval.
- In the case of SD CARD, change to the SD memory card with more free space.

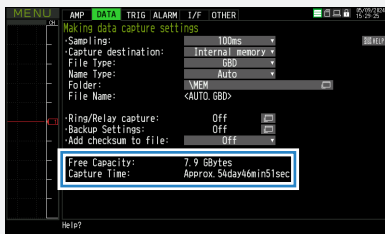

Capture Space: Displays the amount of memory space available for data capture.

Capture Time: Displays time available for at the SD memory card.

* The Capture Time is calculated for 2 GB at the maximum.

The Capture Time more than 366 days is displayed as 366 day over.

When Relay capture is ON, the time that can be captured in the free space is displayed.

2-5. Ring/Relay capturing settings

Sets the ring relay function.



<Ring/Relay Ring Off>

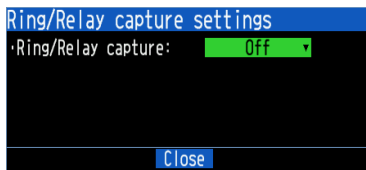

<Ring/Relay Ring>

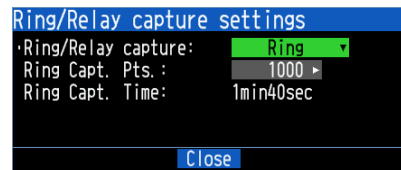

<Ring/Relay Relay/Capacity>

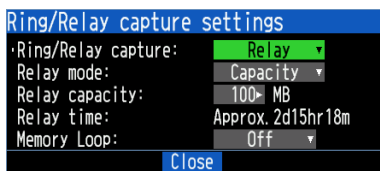

<Ring/Relay Relay/Time>

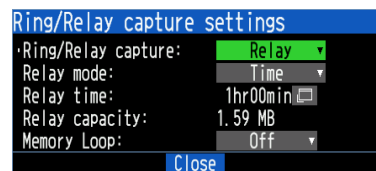

Setting	Selections available	
Ring/Relay capturing	Set the capturing function. Off: The capturing function is disabled. Ring: The ring capturing is executed. (For details, refer to "2-6. Ring capture setting".) Relay: Performs continuous capturing by separating files by the set file size unit or capturing time without missing data.	
Ring Capt. Pts.	When using the ring capturing function, specify the number of data points for one file. (For details, refer to "2-6. Ring capture setting" .)	
Ring Capt. Time	When the ring capturing function is set to On, the measurement time that can be captured in one file is displayed.	
Relay mode	Set the size of the file to be relay-captured by capacity or time. Capacity: Set the size of one file between 100MB and 2GB. Time: Set the size of one file between 1 hour and 24 hours. (For details, refer to "2-6. Ring capture setting" .)	
Capacity	Relay capacity	Set the size of one file between 100MB and 2GB.
	Relay time	The capturing time of one file size set in the relay mode capacity is displayed.
Time	Relay capacity	The size of one file used for capturing in the capturing time set in the relay mode time is displayed.
	Relay time	Set the size of one file between 1 hour and 24 hours.
Memory loop	When capturing with the relay capturing function, set whether to delete the oldest file when the remaining capacity of the save destination is insufficient. Off: No files are deleted. When the remaining capacity of the save destination is insufficient, the disk error is displayed and capturing is stopped. On: Delete old files in the capturing folder and continue capturing. * This cannot be used when FTP is set as the backup destination. If you set to "Delete" in "FTP client settings" – "File setting when the backup is successful", the captured file that has been successfully backed up is deleted to secure the save destination capacity.	

Ring Capture Function

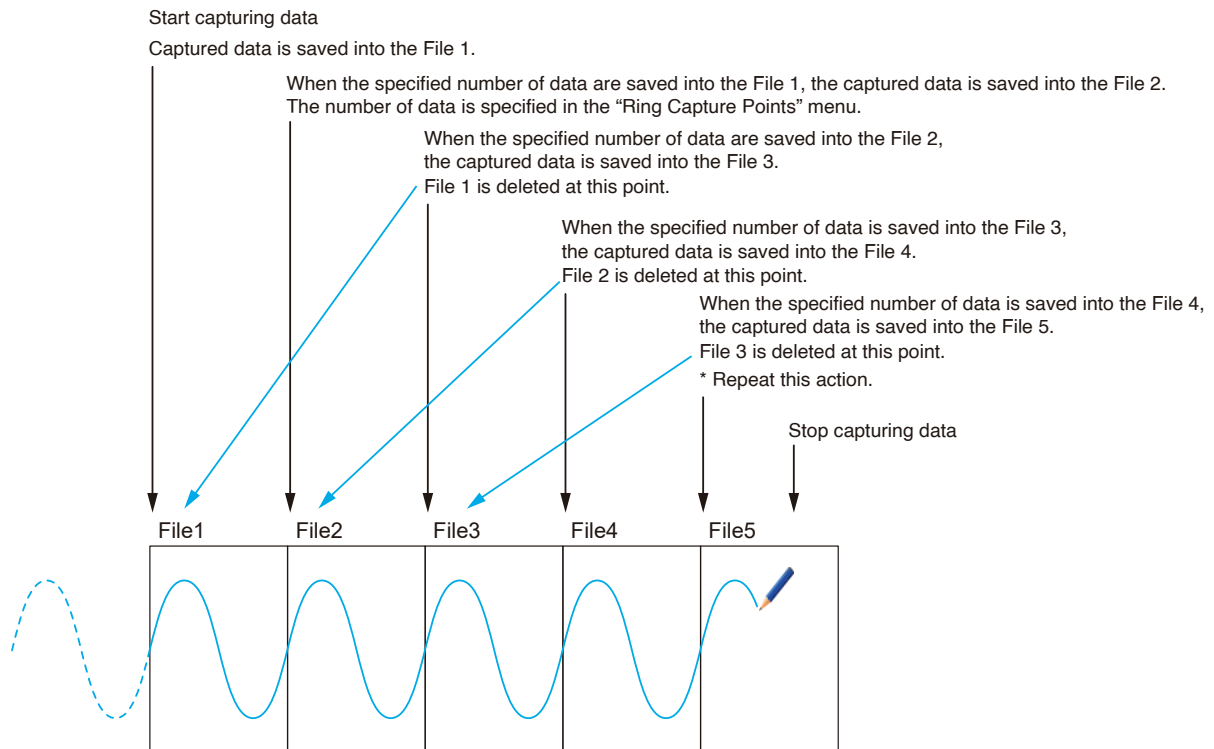

When capturing is stopped at the STOP point above, the File 4 and File 5 remain. These files are consolidated into one file and it is saved. Then the ring capture is completed.

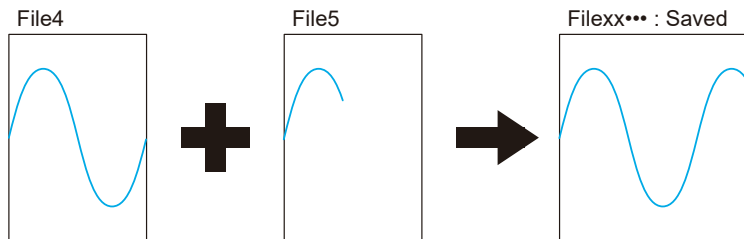

Checkpoint

- Twice as many files as the Number of Ring Capture Points will be created at the maximum.
- If ring capture is On, the backup function is not available.

Relay Capture Function

Files are separated by the set file size or capturing time unit and captured continuously without missing any data. (The capacity for one file is 10MB to 2GB, and the capturing time is 1 hour to 24 hours.)

When the memory loop is set to Off

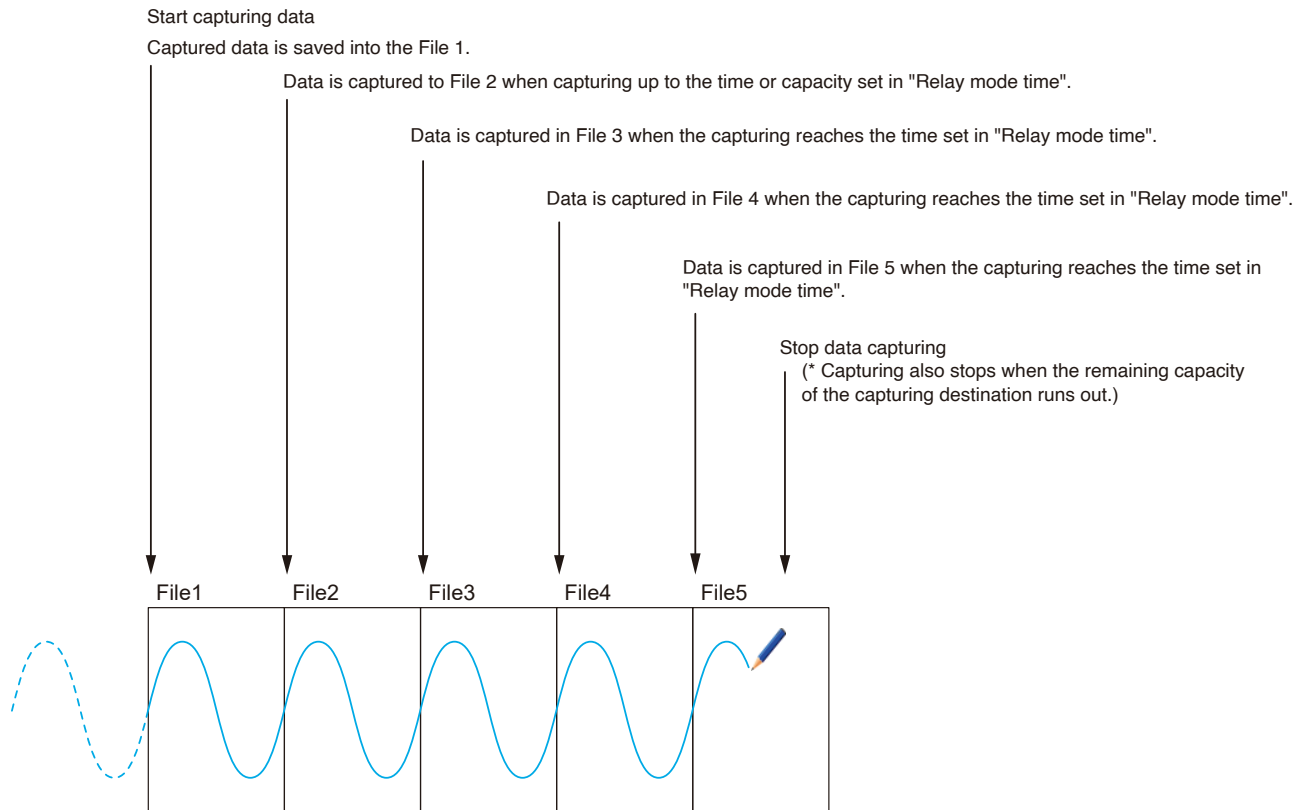

When the memory loop is set to On

When switching the relay file, if the remaining capacity of the capturing destination becomes less than the size of the 3 files set, the oldest files in the capturing folder are deleted.

In the example below, the capacity is set to capture 8 files. Therefore, when capturing to the 6th file, the 1st file is deleted.

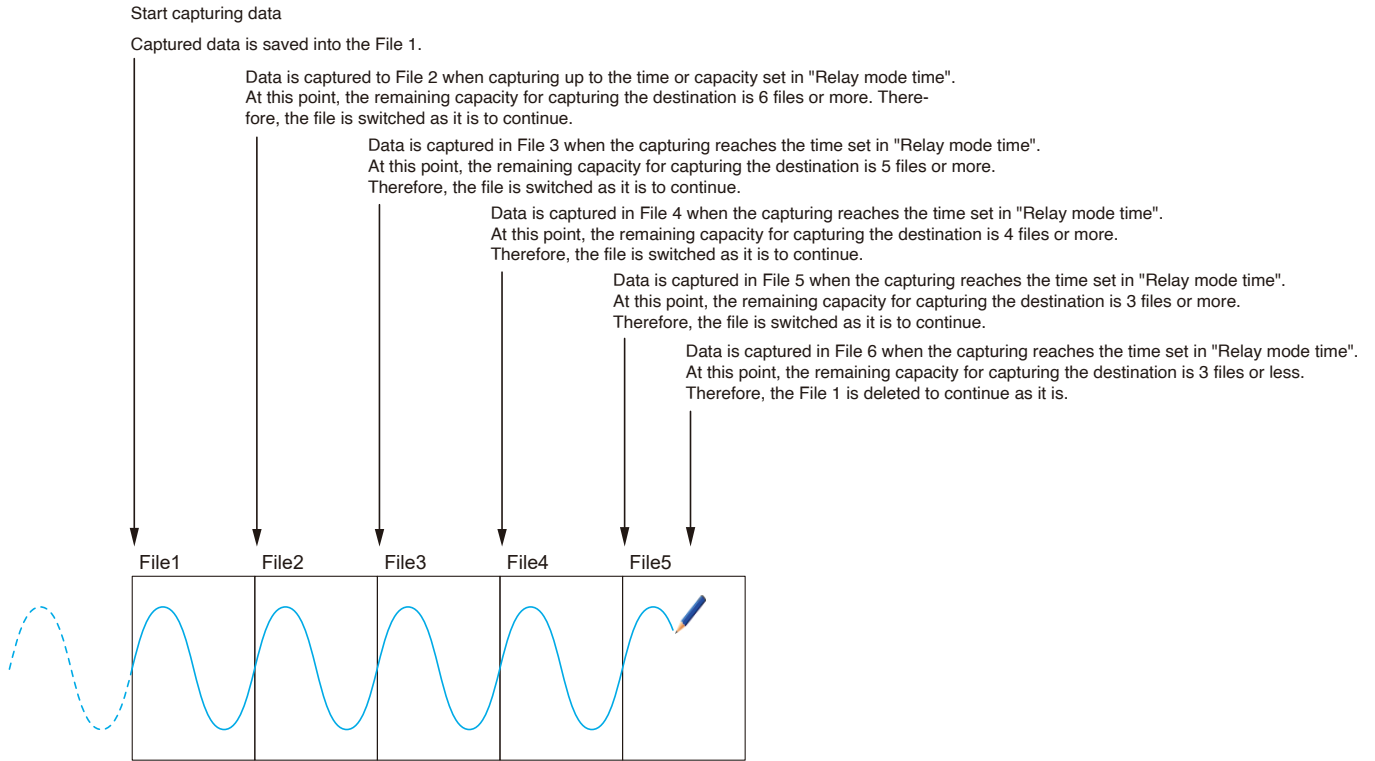

2-6. Backup setting

The GL860 has a function that periodically backs up captured data.

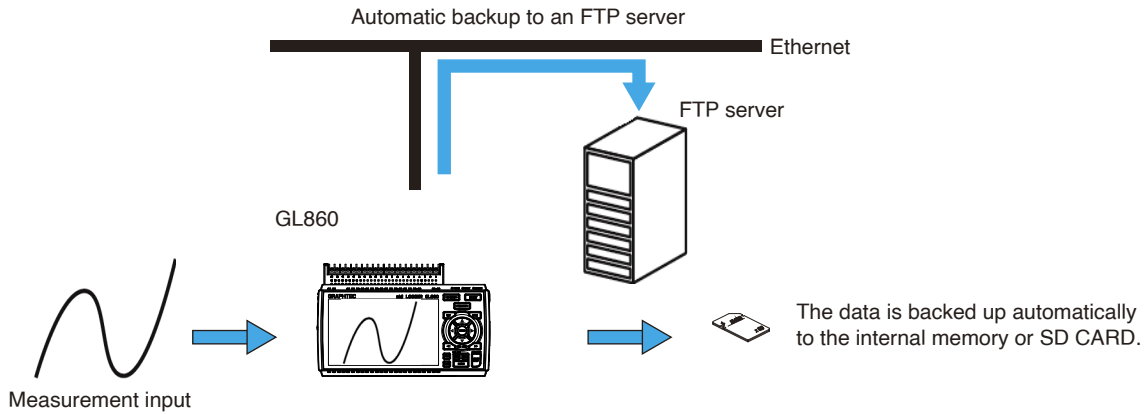

Setting	Selections available
Backup interval	Set the interval for backing up captured data. Off, 1, 2, 6, 12, 24 hours, Each file * Selection of individual files is possible when "Files recorded when backup is successful" in "FTP client settings" is set to "Delete."
Backup destination	Internal memory Back up data to the internal memory. This can only be used when capturing the SD CARD.
	SD CARD Backup data to SD CARD. This can be used only when capturing the internal memory.
	FTP Back up data to an FTP server located on your network. * FTP client setting of I/F setting is required. For details, refer to "5-9. Network settings" – "FTP server settings".

Checkpoint

- When the ring capturing function is set to On, the backup function is not available.
- The memory that is the same as the capture destination cannot set as the backup save folder.
- It takes a time for writing after recoding was stopped when many channels are recoding, when interval sampling is fast, when backup interval is long, because the backup data size becomes large.
- Sometimes the backup will be failed when the backup data is saved to the FTP server via the wireless LAN by condition of Wifi communication.
- CSV format backups can be used with sampling slower than 100ms.
It cannot be used at 5ms,10ms, 20ms, or 50ms.
- When the backup is performing for the CSV Format, the SD Memory Card exchange and the relay recording are not able to perform.
- When the external sampling function is On the backup function is not able to perform.
- When the memory loop function is set to On, you cannot specify FTP as the backup destination.

If the backup fails during capturing, the “backup failure” is displayed as a status message. In that case, the status message will be cleared by executing the error clear.

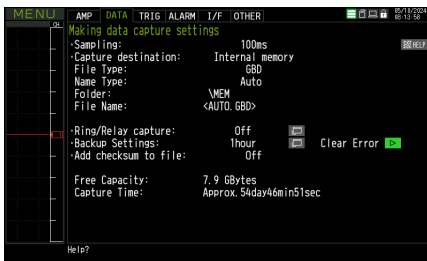

2-7. Data corruption check function

The data corruption check function is a simple check method for checking file integrity.

If the contents of the file have been changed by a third party, etc., a data corruption check shows that the checksum does not match, indicating that the file has been tampered with.

The data corruption check function adds a checksum to the captured file.

Setting	Description
Off	Checksum is not added to the captured file.
On	Checksum is added to the captured file.

* Checksums are also attached to backup files, ring/relay files, and data-saved files.
For the data corruption check function, refer to "11. Data replaying menu" in "3.4 Setting Menus".

CAUTION

- Only files with the file format GBD are valid. Checksum is not added to CSV format files.
- If the captured file is converted with a device other than the GL28-APS, or GL-Connection and saved, the checksum does not match.

3. TRIG settings

Set the trigger conditions.



Setting		Selections available
Start Side Source Setting		Off, Level, Alarm, External Input, Date, Weekly, Time
Level	Mode	Analog: Off, ↑ H, ↓ L, Window In, Window Out Logic: Off, ↑ H, ↓ L Pulse: Off, ↑ H, ↓ L, Window In, Window Out
	Combination	Level OR, Level AND, Edge OR, Edge AND
	Level	Set numeric value
Alarm	Alarm port number	1, 2, 3, 4
Date	Date	From 2023.1.1 to 2035.12.31
	Time	From 0:0:0 to 23:59:59
Weekly	Day of week	Off or On setting for each of Sunday through Saturday
	Time	From 0:0:0 to 23:59:59
Time		From 0:0:1 to 9999:59:59
Stop Side Source Setting		Off, Level, Alarm, External Input, Date, Weekly, Time
Level	Mode	Analog: Off, ↑ H, ↓ L, Window In, Window Out Logic: Off, ↑ H, ↓ L Pulse: Off, ↑ H, ↓ L, Window In, Window Out
	Combination	Level OR, Level AND, Edge OR, Edge AND
	Level	Set numeric value
Alarm	Alarm port number	1, 2, 3, 4
Date	Date	From 1/1/2024 to 12/31/2035
	Time	From 0:0:0 to 23:59:59
Weekly	Day of week	Off or On setting for each of Sunday through Saturday
	Time	From 0:0:0 to 23:59:59
Time		From 0:0:1 to 9999:59:59
Repeated Capturing		Off, On

3-1. Start side source setting

This is used to specify trigger conditions to start data capture.

Selection item	Description
Off	Starts capturing data unconditionally when you press the [START/STOP] key.
Level	Starts capturing data when a specified level is reached. → When Level is selected, the condition for each channel must be set. Refer to "Trigger Level Settings/Alarm Level Settings" described below.
Alarm	Starts capturing data when an alarm is generated in the specified alarm port.
External Input	Starts capturing data when an input signal is received from an external trigger terminal. * A trigger is established at a transition from 5 V (open) to 0 V (shorted to the ground). A falling edge operation occurs.
Date	Starts capturing data when specified date and time arrives.
Weekly	Starts capturing data at the specified time on days of the week for which On is set. <Example> On is set for Mon, Tue, Wed, Thu, and Fri, Off is set for Sun and Sat, and 9:00 is set as the time. Starts capturing data at 9:00 on weekdays. Does not start capturing data on Sat and Sun.
Time	Starts capturing data when a specified length of time elapses.

3-2. Stop side source setting

This is used to specify trigger conditions to stop data capture.

Selection item	Description
Off	Stops capturing data unconditionally when you press the [START/STOP] key.
Level	Stops capturing data when a specified level is reached. -> When Level is selected, the condition for each channel must be set. Refer to "Trigger Level Settings/Alarm Level Settings" described below.
Alarm	Stops capturing data when an alarm is generated in the specified alarm port.
External Input	Stops capturing data when an input signal is received from an external trigger terminal. * A trigger is established at a transition from 5 V (open) to 0 V (shorted to the ground). A falling edge operation occurs.
Date	Stops capturing data when specified date and time arrives.
Weekly	Stops capturing data at the specified time on days of the week for which On is set. <Example> On is set for Mon, Tue, Wed, Thu, and Fri, Off is set for Sun and Sat, and 9:00 is set as the time. Stop capturing data at 9:00 on weekdays. Does not stop capturing data on Sat and Sun.
Time	Stops capturing data when a specified length of time elapses.

Checkpoint

- When External Input is used as the trigger source, no stop trigger is accepted for 50 ms after capture is started.
- When the start trigger is External Input, data is captured at sampling intervals (fixed to 30 seconds if they are more than 30 seconds) and retained temporarily.
This retained data is refreshed at sampling intervals (fixed to 30 seconds if they are more than 30 seconds).
Since the external trigger input operation conducts detection at 10 ms intervals asynchronously from sampling, the retained data becomes the first point when an external trigger is detected. Starting from this point, data is captured at sampling intervals.
- Even when the stop trigger is sent from an external device, the detection is executed in 10 ms. The data capture is stopped when the stop trigger is received.

3-3. Repeated capturing

This is used to enable or disable the repeat function to conduct repeated capturing.

Selection item	Description
Off	The repeat function is disabled.
On	The repeat function is enabled. After one capture is ended, the next capture is started (If the start side source setting is not Off, the GL860 waits for a trigger). When setting to the specified time, the date and time must be set. However, when the repeat function is enabled (On), the specified time is changed to the time display. It occurs the trigger once a day.

4. ALARM settings

Make alarm settings.

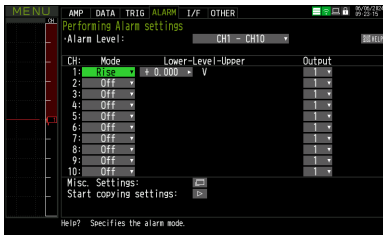

Setting		Selections available
Mode		Analog: Off, ↑ H, ↓ L, Window In, Window Out Logic: Off, ↑ H, ↓ L Pulse: Off, ↑ H, ↓ L, Window In, Window Out
Level		Set numeric value
Output		1, 2, 3, 4
Misc. Settings	Detection Method	Level, Edge
	Alarm Hold	Held or Not held
	Send Burnout Alarm	Sent or not sent
	Alarm History	Off, On

4-1. Alarm level settings

This is used to set alarm generation conditions, output destination, etc.

When the conditions specified here are met, the alarm output terminal (for which an output destination number must be selected for each channel) outputs an alarm.

Refer to "Trigger Level Settings/Alarm Level Settings" described below for the CH condition settings.

4-2. Detection method

Sets the alarm detection method.

Select the alarm detection method from Level or Edge.

For details on operation, refer to "Trigger Level Settings/Alarm Level Settings" described below.

4-3. Alarm hold

If "Alarm retention" is selected here, once the established conditions have been met the alarm status will not be cleared, regardless of whether or not the conditions continue to be met (Clear the alarm by pressing the FUNC key and selecting "Alarm Clear").

4-4. Send burnout alarm

The alarm is output from the alarm output terminal by selecting "Sent" when the burnout occurs (Refer to "6-1-3. Burnout") described below.

4-5. Alarm History

Set how to use the Alarm History function.

Alarm History function

When the Alarm History function is enabled, up to the latest 100 events for alarm occurrence/clearing can be saved.

During data capturing, you can check the events that have occurred.

During data replaying, you can check the event that occurred and move the cursor to the point where the event occurred.

Alarm History data is saved in a file (extension *.GAH) separate from captured data.

It is a file (pair file) with the same file name as the captured data file but with only the extension GAH.

<Example 1>

Data file name: DATA_FILE1.GBD

Alarm History file name: DATA_FILE1.GAH

<Example 2>

Data file name: DATA_FILE2.CSV

Alarm History file name: DATA_FILE2.GAH

An Alarm History file is created when data capturing is complete.

Checkpoint

If a power failure occurs during capturing and the capturing is not stopped normally, the Alarm History file is not created. Also, the Alarm History up to that point is deleted.

If a pair of GAH files exists in the same folder as the data file during data replaying, the Alarm History function during replaying is available.

<Event contents>

Event contents
Alarm occurrence for each CH
Alarms clearing for each CH (when alarms are not held)
Burnout alarm occurrence
Alarm clear key operation
Remote alarm Clear Command execution
Remote alarm output port generation operation
Remote alarm output port clearing operation

Alarm History screen

The Alarm History screen can be displayed by pressing the "DISPLAY" key several times during data capturing.



Description of the alarm history screen

<Capturing>

<When replaying data>

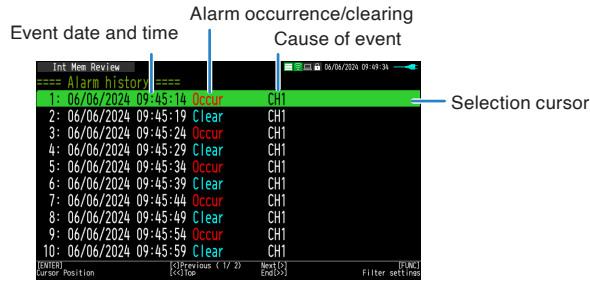
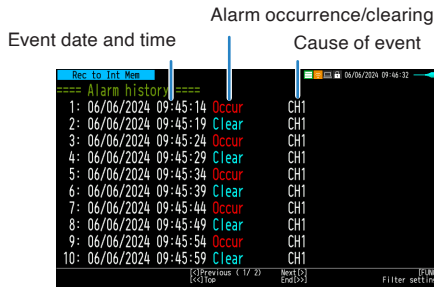

Display	Description
Event date and time	Date and time when the alarm event occurred.
Alarm occurrence/clearing	The alarm occurrence/clearing status is displayed.
Cause of event	The cause of the event is displayed.
Selection cursor	A cursor that selects an event. (Only during replaying)

The Alarm History screen can display 10 alarm events at once. If there are more than 10 alarm events, you can switch pages by pressing the "<>" key. Use the "<<" key to move to the first page, and the ">>" key to move to the last page.

Alarm History filter

Press the "FUNC" key on the Alarm History screen to open the Alarm History filter setting screen.

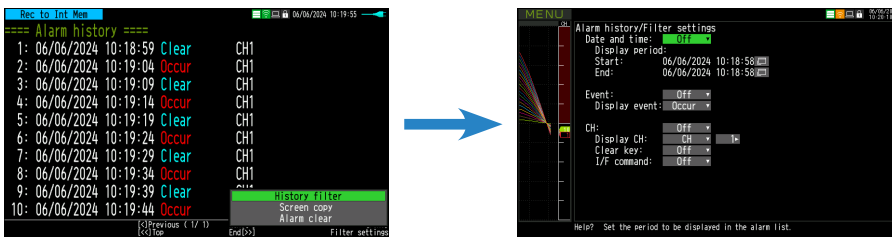

The Alarm History filter allow you to narrow down the alarm events you want to display.

Select items	Setting items
Date and Time	Off, On Enables filtering on the displayed alarm event duration.
Display period	Start Set the date and time to start displaying alarm events.
	Stop Set the date and time to stop displaying alarm events.
Event	Off, On Enables filtering according to the event types to display.
	Display event Occurrence, Clearing
CH	Off, On Enables filtering by factors such as the channel of events to be displayed.
	Display CH CH1-10, LP1-4, CALC1-10
	Clear key Off, On
	I/F command Off, On

Move to alarm event position during replaying

During replaying, you can move the A/B cursor to the selected position by selecting an alarm event in the Alarm History display and pressing the [ENTER] key.

You can quickly move to the alarm event position, which is useful for understanding the cause of the alarm.

Trigger level settings/Alarm level settings

Specifies detailed conditions for each channel when the start and stop side source settings are Level. The configuration of the level trigger is shown in the figure below.

<For trigger>

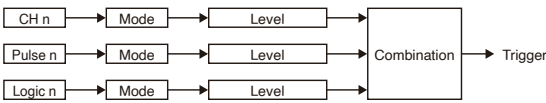

* Pulse and Logic are switchable.

<For alarm>

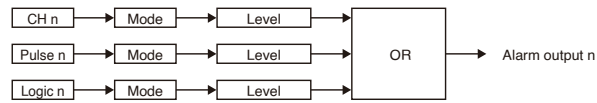

* Pulse and Logic are switchable.
 * Specify an alarm output destination for each channel and Pulse/Logic.
 Each of the alarms is ORed at the output destination.

Example: If you specify 1 as the output destination of 1CH and 2CH and 2 as that of 3CH and 4CH, Alarm Output 1 occurs when one of 1CH and 2CH meets the conditions, and Alarm Output 2 occurs when one of 3CH and 4CH meets the conditions.

<Trigger level settings>

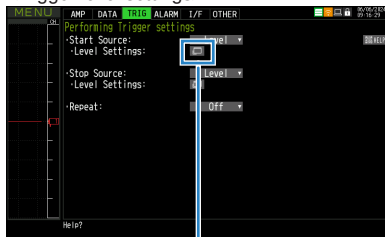

Place the cursor here and press the [ENTER] key to open the following setting screen.

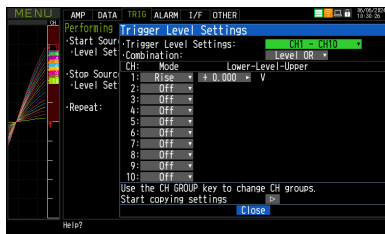

<Alarm level settings>

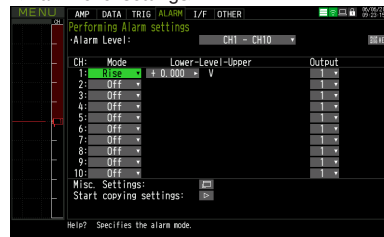

Select items	Description
Combination (For Trigger)	Sets a combination of trigger conditions for each channel. Level OR: Starts (stops) capturing data when at least one of the specified trigger conditions is met. Each condition is a Level operation. Level AND: Starts (stops) capturing data when all of the specified trigger conditions are met. Each condition is a Level operation. Edge OR: Starts (stops) capturing data when at least one of the specified trigger conditions is met. Each condition is Edge operation. Edge AND: Starts (stops) capturing data when all of the specified trigger conditions are met. Each condition is Edge operation.
Mode	Sets a trigger comparison mode for each channel. Off: Disables triggers for the setting channel. ↑ H (rising): A trigger is generated when the input signal exceeds the specified level. ↓ L (falling): A trigger is generated when the input signal falls below the specified level. Win In: Used to specify the upper and lower limits for each channel. When the input signal level is (or comes) between these limits, a trigger is generated. Win Out: Used to specify the upper and lower limits for each channel. When the input signal level is (or goes) out of these limits, a trigger is generated. * There is no Window In setting and Window Out setting for logic CH.
Level	Set the level for comparing triggers and alarms. If the mode is ↑ H (rising) or ↓ L (falling), set one comparison level. If the mode is Win In or Win Out, set two comparison levels.

Level and Edge operations

In the Level operation, a trigger is assumed to be generated if the trigger/alarm conditions are met when the [START] key is pressed.

In the Edge operation, even if the trigger/alarm level achieves the trigger/alarm generation level when the [START] key is pressed, it is not considered the trigger/alarm condition is satisfied if the level does not exceed the set level. A trigger is assumed to be generated when the trigger/alarm conditions, after not being met, are met again.

* A trigger is still assumed to be generated even if the trigger conditions are met once in the Edge operation and then are no longer met.

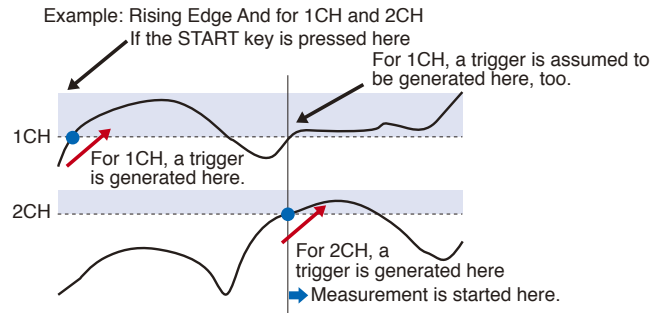
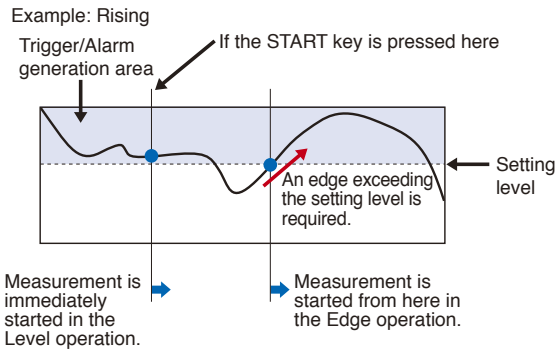

Trigger and Alarm operations

Rising: A trigger/alarm is generated when the input signal is higher than the specified level.

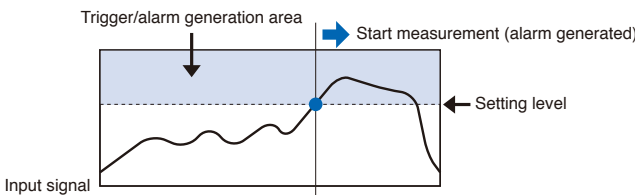

Falling: A trigger/alarm is generated when the input signal is lower than the specified level.

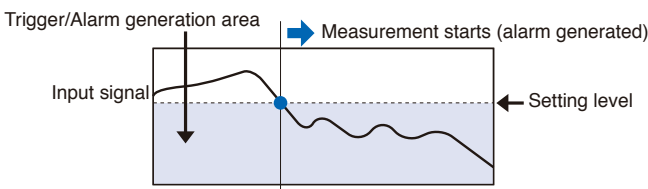

Win In: Set the lower and upper levels for each channel. A trigger/alarm occurs when the input signal is between the two levels.

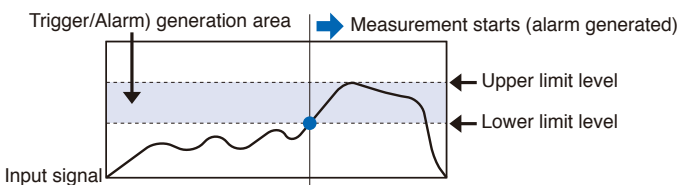

Win Out: Set the lower and upper levels for each channel. A trigger/alarm occurs when the input signal is not between both levels.

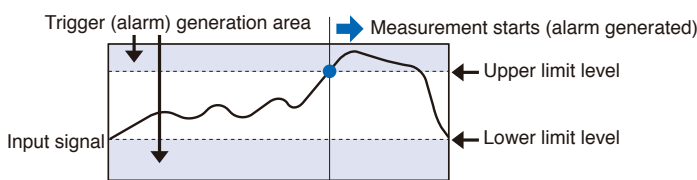

Dead zones of trigger and alarm levels

Trigger and alarm levels are provided with a dead zone to prevent false detection due to noise. The following figure shows the dead zone.

Mode: Rising

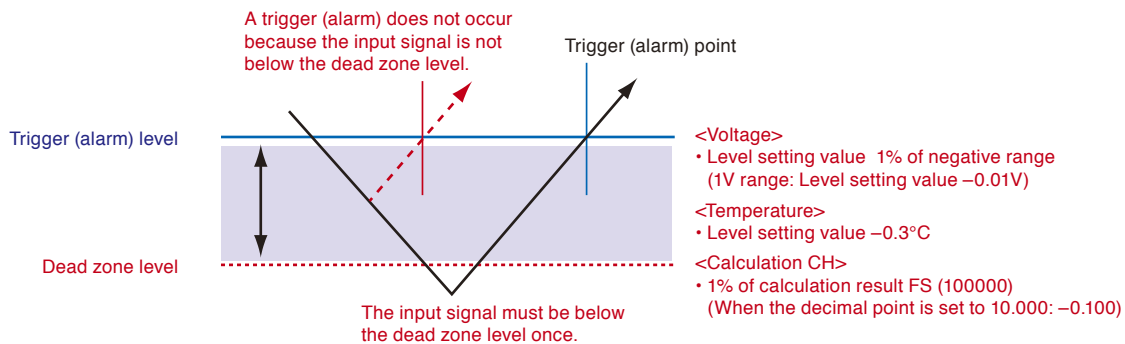

Mode: Falling

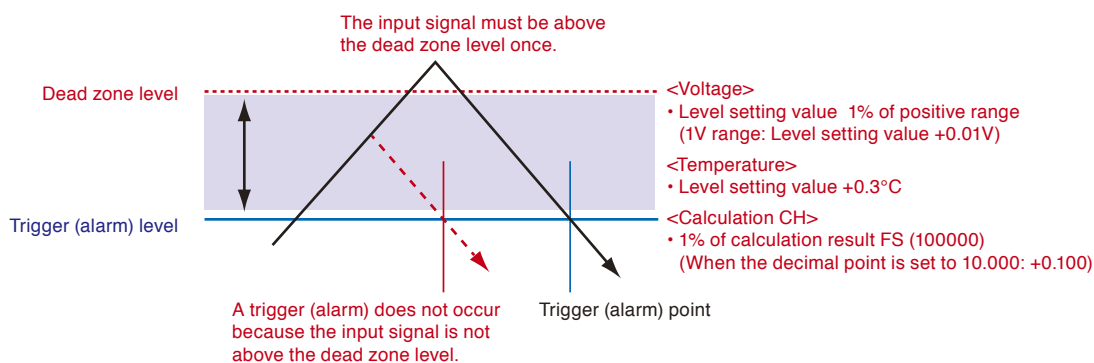

Checkpoint

- The upper limit values within the mode range and the lower limit values out of the mode range are dead zone level as well.
- When the detected alarm drops below the dead zone level, it is cleared. (When the alarm is not retained)
 <Example> When measuring temperature, the level released after the alarm generated is shown below.
 - Rising setting: Setting value $-0.3^{\circ}C$
 - Falling setting: Setting value $+0.3^{\circ}C$
- In the case of pulse, dead zone is not provided.

Copy trigger (level value) and alarm settings

This function copies the trigger (level value) and alarm settings set in any CH to other CHs.

<Confirm>

Copying is not possible in the following cases.

- If the analog input, logic/pulse/calculation CH is different.
- If the input is different.
- If the EU settings are different.
- If the range is different.
- If EU is enabled and the decimal point position is different.
- If the temperature range is different.

(4)-6 How to specify the channel to copy trigger settings

1. Select a level value in the START source setting or STOP source setting on the "TRIG" tab.



2. Open the level settings.
3. Start copying settings.

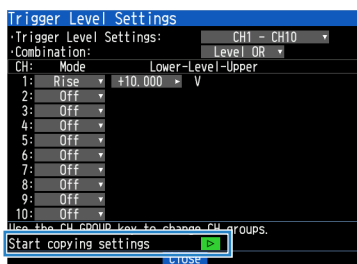

4. Select the source CH. The source CH will be marked with a "*" mark.

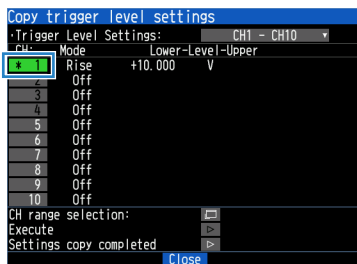

Checkpoint

If you select the same CH again, the copy source will be cancelled.

5. Specify the copy destination. The copy destination CH will be marked with a ">" mark. You can specify multiple copy destinations, and specifying a CH again will remove it from the copy destination.

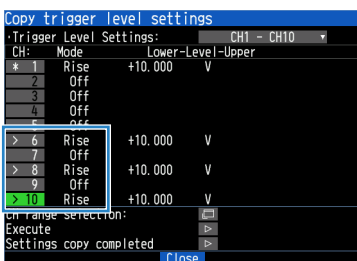

Checkpoint

Only copyable channels can be selected.

- Execute the copy.

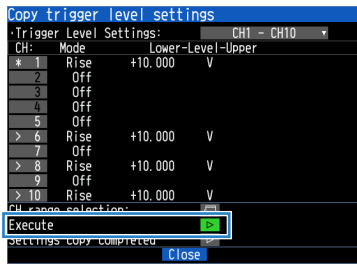

- The copy will be executed. When you finish copying the settings, the copy mode will end.

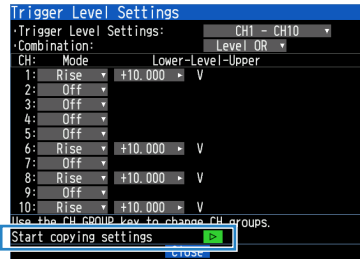

(4)-7 How to specify the copy channel range

- Select a level value in the START SOURCE setting or STOP SOURCE setting on the "TRIG" tab.

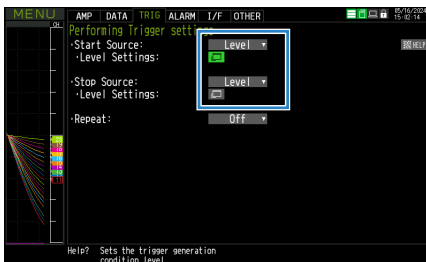

- Open the level settings.
- Start copying settings.

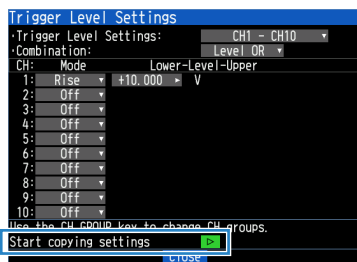

- Open the CH range selection.

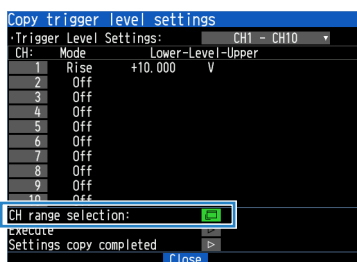

- Set the range of source and destination CHs, then press "OK."

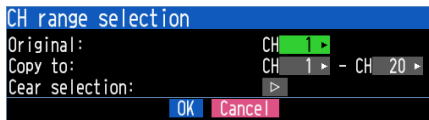

Checkpoint

If you clear the selection, the currently selected CH will be cleared and you will return to the previous screen.

- Verify that the source CH has a "*" mark and the destination CH has an ">" mark and click Execute.

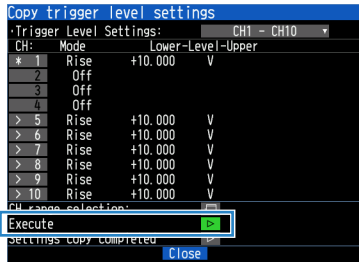

Checkpoint

CHs with different AMP settings are grayed out and cannot be copied.

- The specified CH will be copied.

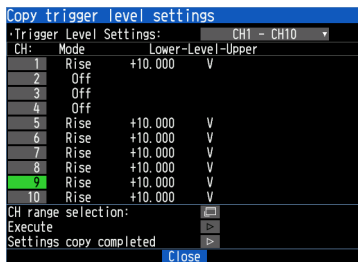

- The copy will be executed. When you finish copying the settings, the copy mode will end.

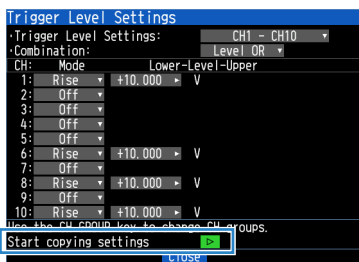

(4)-8 How to specify the channel to copy alarm settings

1. Copy the settings on the ALARM tab.

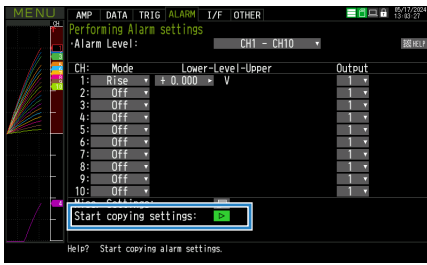

2. Select the source CH. The source CH will be marked with a "*" mark.

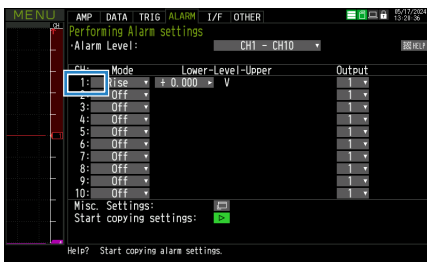

Checkpoint

If you clear the selection, the currently selected CH will be cleared and you will return to the previous screen.

3. Specify the copy destination. The copy destination CH will be marked with a ">" mark.
You can specify multiple copy destinations, and specifying a CH again will remove it from the copy destination.

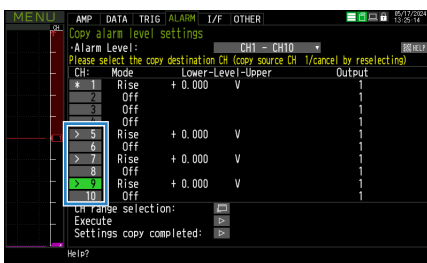

Checkpoint

Only copyable CHs can be selected.

4. Execute the copy.

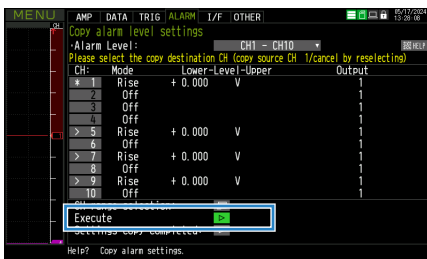

- The copy will be executed.

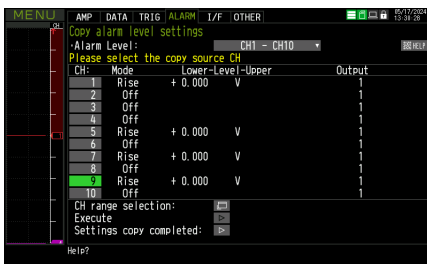

- When you finish copying the settings, the copy mode will end.

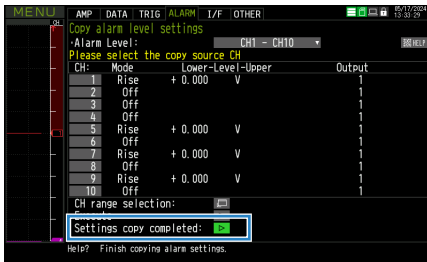

(4)-9 How to specify the channel range for copying alarm settings

- Copy the settings on the ALARM tab.

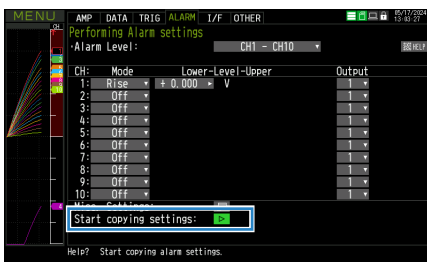

- Open the CH range selection.

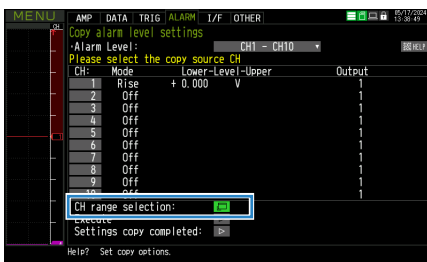

- Set the source CH and copy the CH range and press "OK".



Checkpoint

If you clear the selection, the currently selected CH will be cleared and you will return to the previous screen.

4. Verify that the source CH has an "*" mark and the destination CH has an ">" mark and click Execute.

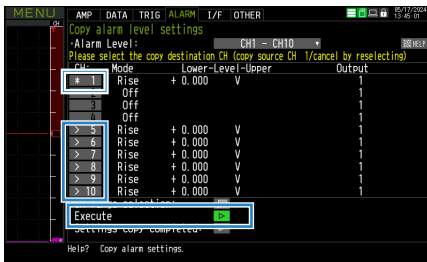

5. The copy will be executed.

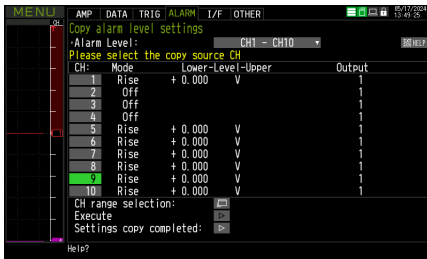

6. When you finish copying the settings, the copy mode will end.

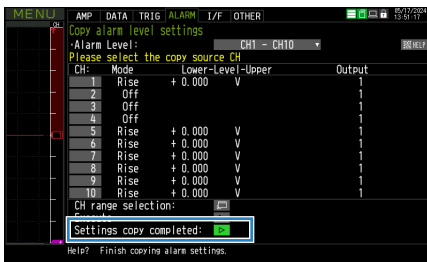

5. Interface settings

This menu is used to specify conditions for PC connection.

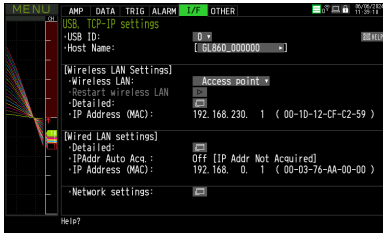

Setting		Description
USB ID		0 to 9
Host Name		Character string: up to 15 characters
Wireless LAN settings (Only when the wireless LAN unit is installed)	Wireless LAN	Off, Station, Access point
	Restart	Restart the wireless LAN function. When you switch stations or access points, be sure to restart.
	Detailed	Make advanced settings for wireless LAN settings.
Wired LAN settings	Detailed	Make advanced settings for wired LAN settings.
Network settings		Make each server settings, etc.

WLAN settings (Station)

Setting		Description	
Wireless LAN		Off, Station and Access point	
Restart Wireless LAN		Restart the wireless LAN function. If you switch between the station and the access point, please perform a restart.	
AUTO SETTINGS (WPS)	WPS system	Push button method, PIN method	
	PIN method	PIN code	Enter the PIN code displayed on the station you want to connect to.
	WPS execution		Execute WPS.
SSID search		Perform SSID search for nearby access points.	
SSID input		String input: up to 32 characters	
Encryption method		NONE, WEP, WPA-PSK/WPA2-PSK	
WEP	WEP key	10 digits for WEP64 and 26 digits for WEP128 alphanumeric characters.	
WPA-PSK/ WPA2-PSK	Password	Set a password with 8 to 63 alphanumeric characters.	
11n		Off·On	
Apply settings (Connect)		Save the settings and reconnect.	
Disconnect		Disconnect the wireless LAN connection.	
TCP-IP Settings	IP address automatic acquisition	Do not use, Use	
	IP address	0 to 255.0 to 255.0 to 255.0 to 255 (only when the IP address automatic acquisition is not used.)	
	Subnet mask	0 to 255.0 to 255.0 to 255.0 to 255 (Only when the IP address automatic acquisition is not used.)	
	Gateway	0 to 255.0 to 255.0 to 255.0 to 255 (Only when the IP address automatic acquisition is not used.)	
	DNS address	0 to 255.0 to 255.0 to 255.0 to 255 (Only when the IP address automatic acquisition is not used.)	
	Apply settings	The contents of the TCP-IP settings are reflected.	

WLAN settings (Access point)

Setting		Description
Wireless LAN		Off, Station and Access point
Restart Wireless LAN		Restart the wireless LAN function. If you switch between the station and the access point, please perform a restart.
AUTO SETTINGS (WPS)	WPS system	Push button method, PIN method
	PIN method	PIN code
	Enter the PIN code displayed on the station you want to connect to.	
WPS execution		Execute WPS.
SSID input		Character string: up to 32 characters
Encryption method		NONE, WEP, WPA-PSK/WPA2-PSK
WEP	WEP key	10 digits for WEP64 and 26 digits for WEP128 alphanumeric characters.
	WPA-PSK/WPA2-PSK	Password
Set a password with 8 to 63 alphanumeric characters.		
Stealth		Off, On
Channel		1ch to 13ch
11n		Off, On
Apply settings (Restart wireless LAN)		The encryption method, WEP key and password settings are reflected.
IP address automatic acquisition	IP address	192.168.xxx.1: the part other than xxx is fixed. xxx: 0 to 255
	Apply settings	The contents of the TCP-IP settings are reflected.

Wired LAN detailed settings

Setting	Description
IP address automatic acquisition	Do not use, Use
IP address	0 to 255.0 to 255.0 to 255.0 to 255 (only when the IP address automatic acquisition is not used.)
Subnet mask	0 to 255.0 to 255.0 to 255.0 to 255 (Only when the IP address automatic acquisition is not used.)
Gateway	0 to 255.0 to 255.0 to 255.0 to 255 (Only when the IP address automatic acquisition is not used.)
DNS address	0 to 255.0 to 255.0 to 255.0 to 255 (Only when the IP address automatic acquisition is not used.)
Apply settings	The contents of the TCP-IP settings are reflected.

Network settings

Setting	Description	
New Line Code	CR+LF·LF·CR	
I/F command function	I/F command function	Off, On
	Port number	1024 ~ 65535
	Keep Alive	Off, 10 seconds, 30 seconds, 1 minute, 10 minutes, 30 minutes, 1 hour
FTP Client Settings	Destination FTP server	Enter up to 127-character string
	User Name	Enter up to 31-character string
	Password	Enter up to 31-character string
	Port Number	0 to 65535
	PASV Mode	Off, On
	Encryption method	Off, Explicit, Implicit
	FTP server connection test	Execute a connection test
	File captured when the backup is successful	Leave, Delete
FTP Server Settings	FTP Server Function	Off, On
	Anonymous connection	Disable, Enable
	User name	Enter up to 31-character string
	Password	Enter up to 31-character string
	Port number	0 to 65535

Setting		Description
WEB Servers Settings	Web server function	Off, On
	Port Number	0 to 65535
	Basic authentication	Off, On
	User name	Enter up to 31-character string
	Password	Enter up to 31-character string
Mail Settings		
E-mail Send Settings		
Account settings	Email address	Enter up to 63-character string
	Destination settings	To
	CC1	Enter up to 63-character string
	CC2	Enter up to 63-character string
	CC3	Enter up to 63-character string
	Subject.	Enter up to 63-character string
E-mail Send Server Settings		
Easy setting		Arbitrary, Simple send, gmail, yahoo.co.jp, yahoo.com, Office365
Send (SMTP) Server Name		Enter up to 63-character string
SMTP port number		0 to 65535
Time zone		UTC-12:00 to UTC+13:00
SMTP setting	SMTP authentication method	Off, SMTP-AUTH
	SMTP-AUTH	PLAIN, LOGIN, CRAM-MD5
	SMTP user name	Enter up to 63-character string
	SMTP password	Enter up to 63-character string
	SMTP encryption	PLAIN, LOGIN, CRAM-MD5, DIGEST-MD5
Test email		Execute a test send.
Notification settings		
Alarm		Off, On
	Screen copy attachment	Off, On
Low Battery		Off, On
Low signal strength		Off, On
Disk Error		Off, On
Periodic notification		Off, 1 hour, 2 hours, 3 hours, 6 hours, 12 hours, specified time
Specified time	Hour	0 to 23
	Minute	0 to 59
	Second	0 to 59
Screen copy attachment		Off, On
G-REMOTE setting	User name	Enter up to 31-character string
	Password	Enter up to 31-character string
	Keep Alive	Off, 10 seconds, 30 seconds, 1 minute, 10 minutes, 30 minutes, 1 hour
	Connection confirmation	Check the connection with the G-REMOTE server.
Network time settings	Interface Time	Off, On
	NTP Server	Enter up to 127-character string
	Time zone	UTC-12:00 to UTC+13:00
	Synchronization Time	00:00 to 23:59
	Adjust Mode	Synchronize at once, Synchronize gradually
	Connection Test	Execute a connection test with the NTP server.
Log settings	Communication	Off, Wireless LAN, Wired LAN *The packet log will be saved to the file displayed.
	G-REMOTE	Off, On

5-1. USB ID

Sets the USB ID number of GL860.

Specify a number from 0 to 9 (default value: 0).

To control more than one GL860 unit with one PC, assign a unique USB ID to each of them.

5-2. Host Name

Set a name for identification in the supplied application.

The initial value is set to GL860_<serial number>.

* This Identification name is not a general computer name (NetBIOS name) or a name for DNS.

5-3. Wireless LAN setting

This is used to set the conditions when connecting the GL860 to wireless LAN.



1. Perform the wireless LAN settings.

Selection item	Description
Off	The wireless LAN is not used.
Station	The GL860 is set to the child unit
Access point	The GL860 is set to the base unit.

2. Restart the wireless LAN.

When restarting after selecting the wireless LAN, the information of the station or the access point is displayed. It takes some time to display.

Checkpoint

After executing “Wireless LAN restart” once, the wireless LAN cannot be selected. When the wireless LAN selection is changed, the restart is enabled.

“Disconnect” → “Wireless LAN restarting” → “TCP-IP restarting” are executed.

The access point can also operate simultaneously with a wired LAN, but does not perform routing between the two networks.

5-4. Station setting

When connecting to the commercially available wireless LAN base unit and controlling multiple GL860s from a PC, the e-mail send function of the GL860 and Internet connection are available. (The following conditions are required to use them.)

- PC connectable to Wireless LAN.
- Wireless LAN base unit. (Wi-Fi-authenticated devices equipped with wireless LAN base unit functions.)
- Internet connection environment when connecting to the Internet.
(Internet provider's contracts and mobile carrier's contracts, etc.)
- Internet connection and e-mail send environments when sending the e-mail.
(E-mail and webmail must be able to send and receive in the SMTP and SMTP via the Internet provider.)

Each station function must be set when the GL860 operates as a child unit.

When the station is selected in the wireless LAN settings and the wireless LAN is restarted, the following screen is displayed.

Checkpoint

- Station (operated as remote unit)
This is the settings for controlling from a PC and transferring data to a PC after connecting to the separately sold wireless LAN base unit. When in station configuration, wired LAN cannot be used.
- After executing "Wireless LAN restart" once, the wireless LAN cannot be selected. When the wireless LAN selection is changed, the restart is enabled.
"Disconnect" "Wireless LAN restarting" "TCP-IP restarting" are executed.

<If the NONE>

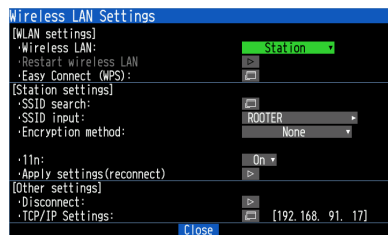

<If the WEP>

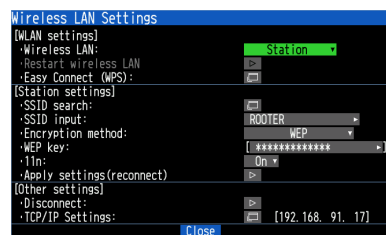

<If the WPA-PSK/WPA2-PSK>

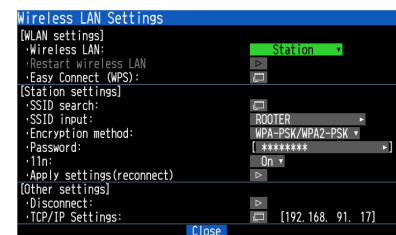

Selection item	Description
Wireless LAN	Switches between Off, Stations and Access points. Select the setting to change and execute "Wireless LAN Restart".
AUTO SETTING (WPS)	Execute auto-connect using WPS. For details, refer to "How to use WPS".
SSID search	A list of wireless access points (base unit) can be displayed by searching for an SID. When you select the access point (base unit) to connect in the list, it is displayed in the SSID input.
SSID input	Set the SSID (access point identification name) of the access point (base unit) to be connected. Up to 32 characters can be entered using alphanumeric characters and symbols.
Encryption method	Set the encryption method to NONE, WEP, WPA-PSK/WPA2-PSK.
WEP key	Set the WEP key with 10-digit alphanumeric characters for WEP64 and 26-digit alphanumeric characters for WEP128.
Password	Set a password with 8 to 63 alphanumeric characters.
11n	Select whether to use wireless standard 11n or not.
Apply settings (Connect)	Save the settings and reconnect.
Disconnection	Disconnect the wireless LAN connection.
TCP-IP settings	Acquire the station IP address setting of the wireless LAN unit automatically or set it manually. After setting, reflect the settings ("▷" key) and restart to complete. For server settings, refer to "5-9. Network settings".

<Operation procedure>

1. Select the station, and then execute the wireless LAN restart.

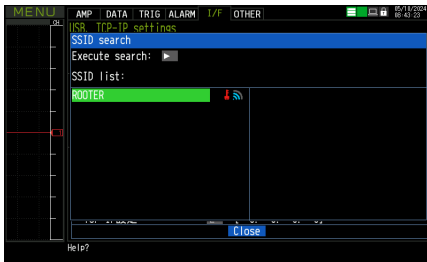

The "Wireless LAN restarting" is displayed and the restart is executed by the station setting.

2. Set the automatic setting (WPS).
The wireless LAN is automatically set in the WPS system.
3. In the absence of the use of automatic configuration (WPS), it is necessary to undertake a manual configuration of the access point to be connected.
Set the SSID of the access point you want to connect to.
If you select "Search for SSID", the SSID search dialog will be displayed.
The SSID will be searched and displayed in a list.

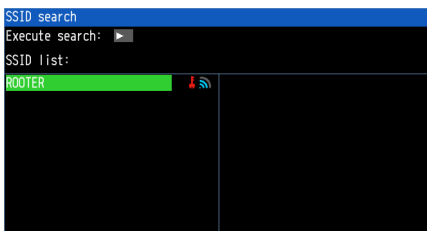

When the SSID is selected from this list, the SSID is automatically reflected in "SSID Input".
You can also enter the SSID manually.
Enter according to the procedure in "10. Text input" described later.

4. Set the encryption method.
WEP or WPA-PSK/WPA2-PSK settings can be performed.
When you select "WEP", the "WEP key" is displayed. When "WPA-PSK/WPA2-PSK" is selected, "Password" is displayed. Enter according to the procedure in "10. Text input" described later.
When "WPA-PSK/WPA2-PSK" is selected, the highest strength for WPA and WPA2 of wireless LAN authentication methods and TKIP and AES of encryption methods is automatically selected.
5. Set the wireless standard 11n.
When the IEEE802.11n is used, set it to "ON".
6. After completing the above settings, execute "Setting reflection (connection)" with the "▷" key.

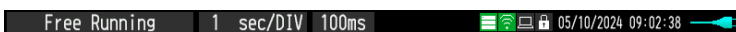

Effective display

* If disconnection is executed while connected, the connection with the base unit is disconnected

5-5. TCP-IP setting

IP address auto acquisition Use

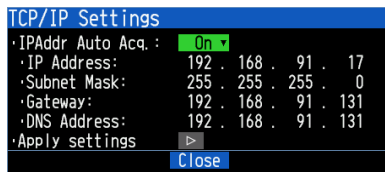

IP address auto acquisition Do not use

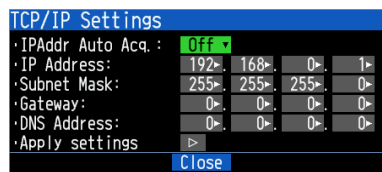

Selection item	Description
IP address auto-acquisition	Do not use, Use Do not use: When you do not use "IP address auto acquisition", select "Do not use" and set the IP address, Subnet mask, Port number, etc. Use: Select "Use" to use "IP address auto acquisition".
IP Address	Set the IP address when "Do not use DHCP" is set. The acquired IP address when "Use DHCP" is set is displayed.
Subnet mask	Set the Sub-net mask when "Do not use DHCP" is set. The acquired Sub-net mask when "Use DHCP" is set is displayed.
Gateway	Set the gateway address when "Do not use DHCP" is set. The acquired gateway address when "Use DHCP" is set is displayed.
DNS Address	Set the DNS server address when "Do not use DHCP" is set. The acquired DNS server address when "Use DHCP" is set is displayed.
Apply Settings	Restart the set TCP-IP to reflect the settings. Stay connected while the wireless LAN is disconnected.

5-6. Access point setting

The access point setting is a setting when the GL860 operates as a base unit.

Wireless connection with a PC is possible using the GL860 as a base unit.

When selecting the wireless LAN as a station and then restarting the wireless LAN, the following screen is displayed.

<Encryption Method: None>



<Encryption method: WEP>



<Encryption method: WPA-PSK/WPA2-PSK>

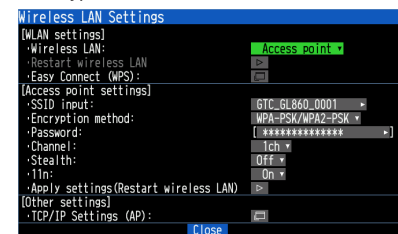

Selection item	Description
Wireless LAN	Switch between Off, Station and Access points. Select the setting you want to change and execute "Wireless LAN restart".
AUTO SETTING (WPS)	Execute the auto-connect using WPS. For details, refer to "How to use WPS".
SSID input	Set the SSID (access point identification name) of the GL860. Up to 32 characters of the alphanumeric characters and symbols can be entered.
Encryption method	Make the settings of None, WEP, WPA-PSK/WPA2-PSK encryption.
WEP key	When you set encryption, it is displayed, so set the key. Set the WEP key with 10 digits for WEP64 and 26 digits for WEP128.
Password	Set a password with 8 to 63 alphanumeric characters.
Stealth	Set the SSID concealment mode.
Channel	Perform 1ch to 13ch settings.
11n	Select whether or not to use the wireless standard 11n.
Apply settings (Restart Wireless LAN)	Reflects the encryption method, WEP key and password settings.
TCP-IP settings	Make TCP-IP settings. After setting, reflect the settings and restart to complete.

<Operation procedure>

1. Set the SSID.
Enter in accordance with the procedure in "10. Text input" described below.
By default, the identification name automatically generated from the GL860 name is displayed.
2. Set the encryption method.
WEP or WPA-PSK/WPA2-PSK settings can be performed.
When the WIP system is selected, the [WEP] key is displayed.
When the WPA-PS/WPA2-PSK system is selected, the "Password" is displayed. Then, enter in accordance with the procedure in "10. Text input" described below.
When "WPA-PSK/WPA2-PSK" is selected, the highest strength for WPA and WPA2 of wireless LAN authentication methods and TKIP and AES of encryption methods is automatically selected.
3. After the encryption method setting in the (2) step is completed, the automatic setting (WPS) can be set.
The push button method or PIN method can be selected.
Set the wireless LAN channel to be used from 1ch to 13ch.
4. Set the stealth.
This is used to set it as so to not be able to search the SSID from the other terminal.
Enter directly the SSID name of the device to be connected.
5. Set the wireless standard 11n.
When the IEEE802.11n is used, set it to "On".

Select the "Reflection of setting" with the ">" key when the above settings are finished.

The "Wireless LAN restarting" message is displayed and the main unit is re-started to reflect the settings.

5-7. TCP-IP settings (AP)

<TCP-IP settings (AP)>

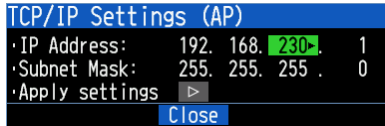

Selection item	Description
IP Address	192.168.xxx.1: the part other than xxx is fixed. xxx: 0 to 255
Subnet Mask	Fixed to "255.255.255.0".
Keep Alive	Set the timeout time to disconnect the connection when no communication. (Valid only for IF command function.)
Apply settings	Restart the set TCP-IP to reflect the settings.

How to use WPS

When setting a station, a wireless router with WPS function and GL860 are used, and when using an access point, the GL860 is used as the base unit to connect a PC, etc., and the connection settings are automatically made.

The WPS function is equipped with two types, the PIN method and the push button method.

PIN method

<For station>

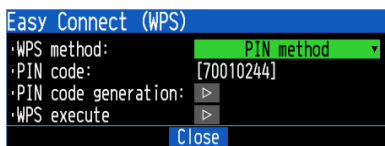

<For access point>

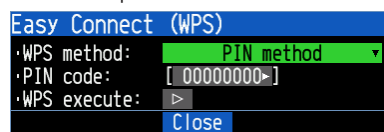

Push button method

<For station>

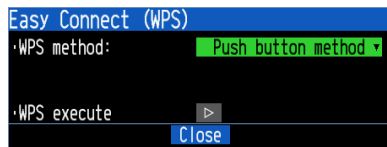

<For access point>

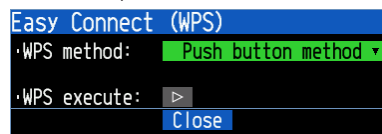

Selection item	Description
WPS method	Select the push button method or PIN method. Push button method: Communication settings can be made simply by pressing the WPS button on both the base and remote unit. PIN method: Enter a common PIN code for both the base and remote unit to make communication settings. * With the push button method, if multiple WPS are running at the same time, unintended units may be connected. In such cases, use the PIN method.
PIN code (Display)	Set the displayed PIN code on the base unit.
PIN code generation	Change PIN code.
PIN code (Input)	Set the displayed PIN code on the remote unit.
WPS execution	Execute WPS. The WEP key or password is set if WPS succeeds.

5-8. Wired LAN settings

This is the settings for connecting the GL860 to the Ethernet unit.

IP address auto acquisition Use

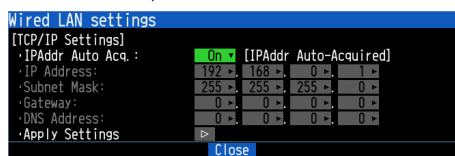

IP address auto acquisition Do not use

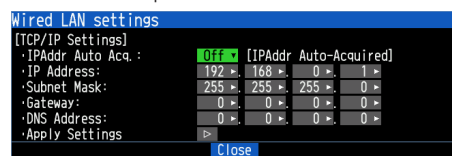

Selection item	Description
IP address auto-acquisition	Set whether the IP address should be manually set or automatically acquired. * If an auto acquisition is enabled, the auto acquisition operation (performed when the power is turned on or the settings are reflected) may take a few seconds to around one minute.
IP Address	Sets the IP address of the GL860. (0-255.0-255.0-255.0-255)
Subnet mask	Sets the subnet mask of the GL860. (0-255.0-255.0-255.0-255)
Gateway	Sets the gateway address of the GL860. (0-255.0-255.0-255.0-255)
DNS Address	Sets the DNS address of the GL860. (0-255.0-255.0-255.0-255)
Apply Settings	Reflects the TCP-IP settings immediately (without turning off and on the power). * Connections are forcibly disconnected when the settings are reflected. * Reflecting on the settings may take a few seconds to around one minute.

CAUTION

- If the Automatic IP Address Acquisition fails, the manual settings for IP address, etc. are used. In this case, the settings including the IP address may not be consistent with your network. Disable the Automatic IP Address Acquisition and make the settings one by one.
- After you changed the Wired LAN settings, turn off and on the power or apply the settings. (The connection will be forcibly disconnected).
- When you want to use the Automatic IP Address Acquisition function, the DHCP server must be operating separately within the searchable network.

5.9. Network settings

Make network settings for each server and client.

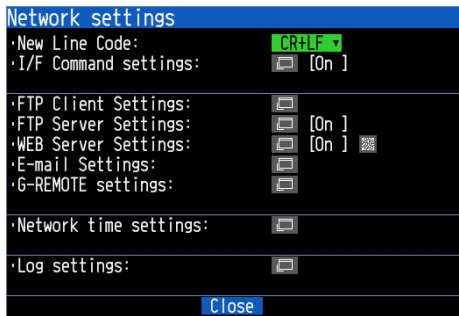

New Line Code

Specifies the line feed code.

Selection item	Description
CR+LF	Starts a new line with CR+LF code.
LF	Starts a new line with LF code.
CR	Starts a new line with CR code.

I/F command function

Set the I/F command function.

<I/F command function>

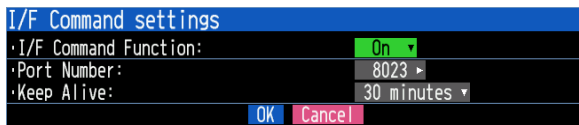

Selection item	Description
I/F command settings	I/F Command Function Off, On Enable/disable the I/F command server function via the network. The I/F command function via TCP/IP affects the UDP/IP server function. The I/F command function via USB can be used regardless of this setting.
	Port number 1024 to 65535 Set the port number used by the IF command function.
	Keep Alive Off, 10 seconds, 30 seconds, 1 minute, 10 minutes, 30 minutes, 1 hour Set the timeout time to disconnect the socket connection when no communication. (Valid only for IF command function.)

CAUTION

When set the I/F command function to Off, you are not be able to connect to our APS (GL28_APS, GL-Connection) via TCP/IP (Wireless LAN). Connection via USB is possible.

FTP Client settings

Make the settings for the backup destination FTP server.

<FTP client settings>

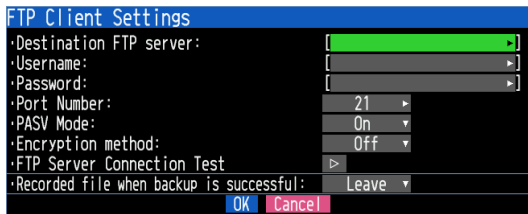

	Selection item	Description
FTP client	Destination FTP server	Enter the domain name or IP address of the FTP server. (Up to 127 characters)
	User name	Enter the user name of the FTP account. (Up to 31 characters)
	Password	Enter the password of the FTP account. (Up to 31 characters)
	Port number	Enter the port number of a port to be used for FTP. It is normally 21. (0 to 65535)
	PASV Mode	Make the passive mode setting. On (Set when the FTP server is under a firewall environment.) OFF (Should be set for communication with an FTP server in a normal network environment.)
	Encryption method	Off, Explicit, Implicit Encrypt data sent and received via FTP. Set according to the settings of the FTP server. Off: No encryption. Explicit: Explicit mode. Start encryption after connecting. Implicit: Implicit mode. Encrypted communication is performed from the point of connection.
	FTP server Connection Test	Press the right ">" key to execute (Performs connection test to the FTP server.) When the connection test is performed, a message is displayed. If a connection cannot be established, check the settings and perform the connection test again. * If the connection test is passed, the message is displayed.
	Recorded file when backup is successful	Leave, Delete Select whether to "Leave" or "Delete" the captured files when the backup to the FTP server is successful. By deleting it, you can capture it for a long time without filling up the SD CARD. * If FTP is set as the backup destination, it cannot be used simultaneously with the memory loop function.

⚠ CAUTION

<Precautions when captured files are set to "Delete" when backup is successful>

- Set the backup interval to "Off" or "Each file".
- Captured files that failed to be backed up remain on the SD CARD without being deleted.
- If the backup fails, a log file (*.LOG) is recorded on the SD CARD, so you can check the status of the failure. Deleting log files does not affect captured files.
- Use after checking the operation in your communication environment.
- When relay capturing is set to On, an SD CARD with at least twice the free space of the set file size is required.
- When capturing for a long time, pay attention to the life of the SD CARD.

<Example of use with settings to be deleted>

- To log files to the FTP server every hour, set the relay time to 1 hour.
The relay file switches every hour, the captured data for 1 hour is saved on the FTP server, and the original file is deleted.

FTP server settings

Set the GL860 to function as an FTP server.

<FTP server settings>

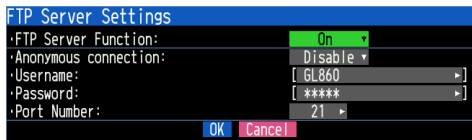

Selection item		Description
FTP server	FTP server Function	Off, On Set the FTP server function to Enable or Disable. On: Enables the FTP server function. Off: Disables the FTP server function. * When you want to disable the FTP server function for security reasons, set it to Off.
	Anonymous connection	Set whether to allow anonymous connections. Disable: Anonymous connections are disabled. Enable: Anonymous connections are enabled.
	User name	Enter the user name of the FTP account. (Up to 31 characters) The default is "GL860".
	Password	Enter the password of the FTP account. (Up to 31 characters) The default is "GL860".
	Port Number	Enter the port number of a port to be used for FTP. It is normally 21. (0 to 65535)

<FTP server function>

When connecting to FTP with a Windows browser, set the user name and password as follows.

If you omit the user name and password, you are automatically logged in with an anonymous account, so users are subject to read-only restrictions. If "Anonymous connection" is set to "Disable", you must set a user name and password.

ftp://<username>:<password>@<FTP server name>

<Example of settings>

FTP server name: 192.168.0.1

User name: GL860

Password: abcd

URL: ftp://GL860:abcd@192.168.0.1

If read-only restrictions are applied, the following operations cannot be performed.

- File upload
- Files/folders deletion
- Files/folders creation
- File name/folder name change

To write to the GL860, you must change the login account.

For the initial value for each anonymous connection setting, refer to the following.

Anonymous connection	Account name	Password	Limit
Disable	GL860	GL860	None
Enable	Anonymous	Arbitrary	Read only

CAUTION

Connecting to an FTP server with an internet browser may be prohibited by the internet browser software.
If your Internet browser cannot connect to the FTP server, use Windows Explorer.

WEB server settings

Perform the WEB server settings.

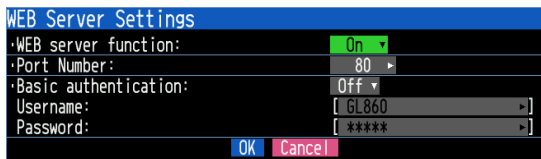

Selection item		Description
WEB server	Web server function	Off, On Set the WEB server function to Enable or Disable. On: Enables the WEB server function. Off: Disables the WEB server function. * When you want to disable the WEB server function for security reasons, set it to Off.
	Port Number	Enter the port number used on the WEB. 80 is normally used. (0 to 65535)
	Basic authentication	When connecting to the WEB server, you can restrict access by username and password. Off: Set basic authentication to Off. On: Set basic authentication to On and restrict access by user name and password.
	User name	Enter the username for basic authentication. (Up to 31 characters) The default is "GL860".
	Password	Enter the password for basic authentication. (Up to 31 characters) The default is "GL860".

E-mail settings

Perform the settings to send the e-mail from the GL860.

The e-mail with the notification setting information (Alarm, Low Battery, Low communication strength, error Information in the internal memory or SD card (only when data capturing) is sent. In addition, when setting to the Periodic notification, the e-mail will be sent at the set time.

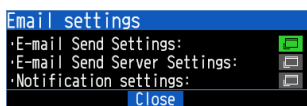

<Outgoing mail setting>

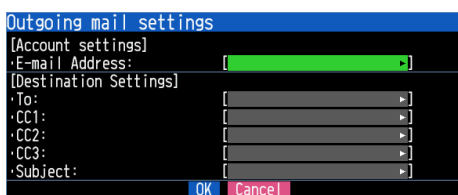

Selection item		Description	
Outgoing mail setting	Account setting	E-mail Address	Set the email address for your email account. (Up to 63 characters)
	Destination Settings	TO	Set the e-mail address of the e-mail destination. (Up to 63 characters)
		CC1 to CC3	Up to three e-mail addresses can be set as CC (carbon copy). (Up to 63 characters)
		Subject	The e-mail subject can be registered in the character string entered. (Up to 63 characters)

<Outgoing mail server settings>

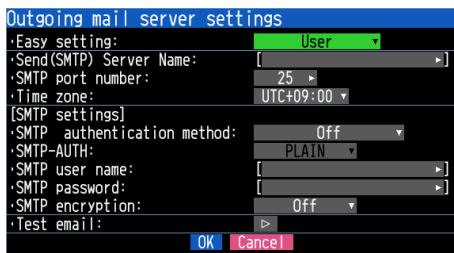

Selection item		Description	
Outgoing mail server settings	Easy setting	Select an Email template. User: Make any settings. Easy sending: Emails are sent using our server. * You can send Emails without SMTP settings. gmail: The template for gmail settings is deployed. yahoo.com: The template for yahoo.com Email settings is deployed. Office365: The templates for Office365 email settings are deployed.	
	Send (SMTP) Server Name	Set the mail destination server name. (Up to 63 characters)	
	SMTP port number	Set from 0 to 65535.	
	Time zone	Set the time zone for the region where the GL860 is used.	
	SMTP settings	SMTP authentication method	Set the SMTP authentication method to Off or SMTP-AUTH.
		SMTP-AUTH	Set the authentication method for SMTP-AUTH authentication to PLAIN, LOGIN, CRAM-MD5 or DIGEST-MD5.
		SMTP user name	Set the user name for SMTP authentication. (Up to 63 characters)
		SMTP password	Set the password for SMTP authentication. (Up to 31 characters)
		SMTP encryption	Set SMTP encryption to Off, StartTLS or Over SSL.
	Test email	Execute an email-sending test.	

<Notification settings>

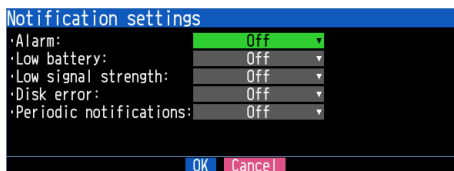

Selection item		Description
Notification settings	Alarm	When set to On, an alarm occurrence is notified.
	Attach screenshot	When set to On, the screen copy at the time of alarm occurrence is attached.
	Low battery	When set to On, low battery information is notified.
	Low signal strength	When set to On, the decrease in communication strength is notified.
	Drive error	When set to On, the error information of the capturing destination memory is notified.
	Periodic notification	When set to anything other than Off, a periodic notification Email is sent. Set whether to send at regular intervals or at a specified time.
	Hour, Minute, Second	Set the time when the periodic notification is set to the specified time. (It is sent once a day at the specified time.)
Attach screenshot	When set to On, a screen copy is attached to the periodic notification Email.	

CAUTION

- Once each notification is sent, the next notification will be sent at least one minute later. Notification events that occur while the notification is pending will be skipped.
Regarding alarm notifications, alarms that occurred during the one-minute notification hold will be notified all at once at the next notification.
- Up to 20 alarms can be notified at once in one alarm notification. If 21 or more alarms have occurred, they will be omitted and the total number will be notified.
- Up to the first 10 screen copies can be attached to one alarm notification.
- The screen copy of the alarm notification will be the screen 500ms after the alarm occurred.
- Depending on the communication environment, an increase in the number of screen copies during alarm notification may affect communication.

G-REMOTE settings

Make G-REMOTE settings.

<G-REMOTE settings>

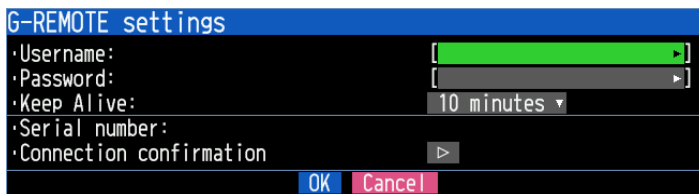

Selection item		Description
G-REMOTE settings	User name	Enter the G-REMOTE user name. (Up to 31 characters)
	Password	Enter the G-REMOTE password. (Up to 31 characters)
	Keep Alive	Off, 10 seconds, 30 seconds, 1 minute, 10 minutes, 30 minutes, 1 hour Set the timeout time to disconnect the connection when no communication. * If communication is not established for 1.5 times the set time, the connection is disconnected.
	Serial number	The serial number of the GL860 is displayed.
	Connection confirmation	When executing a connection test, a message is displayed. If you cannot connect, check the settings and execute the connection test again.

Remote control is performed using our G-REMOTE.

For details, refer to "4. Remote control service cooperation function" in "4.3 Other Functions".

Network time settings

Make the network time settings.

<Network time settings>

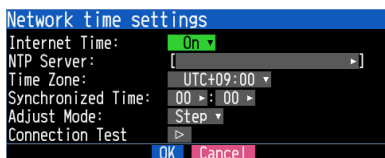

Selection item		Description
Network time settings	Internet Time	Off, On Set whether or not to use this function. Off: This function is not used. No time adjustment is performed. On: Use this function to adjust the time.
	NTP Server	Character string: up to 127 characters Enter the domain name or address of the clock server (NTP server) to use.
	Time Zone	UTC-12:00 to UTC+13:00 Set the time zone for the region where the GL860 is used. (Japan: +09:00)
	Synchronized Time	00:00 to 23:59 Set the time to synchronize with the clock server. When the set time is reached, the time is synchronized by the method set in the sync mode.
	Adjust Mode	Synchronize immediately, Synchronize gradually. Set the method for synchronizing with the clock server. Synchronize immediately: The clock server time is synchronized as soon as the synchronization time is reached. Synchronize gradually: Not synchronized immediately when the synchronization time is reached. It gradually synchronizes with the time of the clock server. The amount of adjustment is about 43 seconds per day. (The amount of adjustment is about 10 ms in 20 seconds.)
	Connection Test	When executing a connection test, a message is displayed. If you cannot connect, check the settings and execute the connection test again.

CAUTION

Synchronization is not performed if the error with the clock server is within 500 ms.

Log settings

Make log settings.

<Log settings>



Selection item		Description
Log settings	Communication	Off, On Sets the LAN interface for collecting logs. If set to anything other than Off, the destination file name will be displayed.
	G-REMOTE	Off, On If set to anything other than Off, the destination file name will be displayed.

- Communication
Communication logs in pcap format will be saved to a file displayed in the setting other than Off.
If you select Off, logs will not be collected.
Wireless LAN is displayed as a selection item only when the wireless LAN option is installed and is set to anything other than Off.
- G-REMOTE
Save the communication log in text format to the file displayed when set to On.

CAUTION

When the communication log is set to On, the communication speed may decrease.

6. OTHER settings

Various conditions can be set.

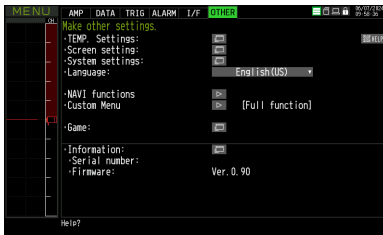

Setting	Selections available
TEMP Settings	Make function settings related to temperature.
Screen settings	Make function settings related to the screen display.
System settings	Make function settings related to the system operation.
Language	Japanese · English(US) · English(UK) · French · German · Chinese · Korean · Russian · Spanish
Navigation function	Executes the NAVI function.
Custom Menu	Select the function to use.
GAME	Various games
Information	The system information on the GL860, such as the firmware version is displayed.

Temperature settings

Setting	Selections available
Room Tempe	Internal, External
Temp unit	°C, °F
Burnout	Off, On

Screen settings

Setting	Selections available
LCD brightness	Bright, Middle, Dark
Screen Saver	Off, 10, 30 (sec.), 1, 2, 5, 10, 30, 60 (min.)
Background Color	Black, White

System settings

Setting	Selections available
Date/Time	Date: From 1/1/2024 to 12/31/2035 Time: From 0:0:0 to 23:59:59
AC Line cycle	50Hz, 60Hz
Return to default settings	Operation settings: Restore Operation settings Communication settings: Restore Communication settings
Power On Start	Disable, Enable
Warm-up time	Off, 30 minutes, 1 hour, 2 hours
Key Click Sound	On, Off
Demo waveform	Off, Sine wave, Triangular wave, Square wave

Navigation function

Setting	Selections available
Easy Capture Settings	Configure the minimum settings required for data recording, such as input settings, sampling settings, and recording destination settings, using a wizard.
Easy Trigger Settings	Trigger settings are configured using a wizard.
Wireless LAN Settings	Wireless LAN connection settings are configured using a wizard.

Custom menu

Setting	Selections available
Select from list	Select the function you want to use from the list.
Select in Wizard	Select the function you want to use in a Wizard format.

6-1. Temperature settings

Make settings for functions related to temperature.

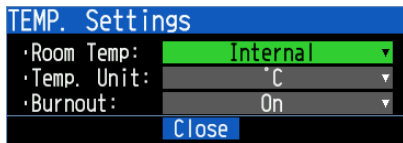

Setting	Selections available
Room Tempe	Internal, External
Temp unit	°C, °F
Burnout	Off, On

6-1-1. Room temperature compensation

Selection item	Description
Internal	The room temperature compensation in the GL860 is enabled. (Please usually select the "Internal".)
External	This is used to execute the room temperature compensation through an external device.

6-1-2. Temp. Unit

Toggles the temperature unit between °C (Centigrade) and °F (Fahrenheit) for temperature settings.

Selection item	Description
°C	Set temperature units to Celsius.
°F	Set temperature units to Fahrenheit.

When °F (Fahrenheit) is selected, a calculation is performed using the following formula:

$$^{\circ}\text{F (Fahrenheit)} = ^{\circ}\text{C (Centigrade)} \times 1.8 + 32$$

Calculate the accuracy as: Centigrade accuracy \times 1.8.

6-1-3. Burnout

Sets a feature that checks sensor burnout in a thermocouple.

Selection item	Description
Off	The burnout check is disabled.
On	A periodic burnout check is conducted.

⚠ CAUTION

During a burnout check, voltage is applied to the GL860. Therefore, set Burnout to "Off" when GL860 is connected in parallel with other devices to avoid any effect from these voltages.

6-2. Screen settings

Make settings for functions related to screen display.



Setting	Selections available
LCD brightness	Bright, Middle, Dark
Screen Saver	Off, 10, 30 (sec.), 1, 2, 5, 10, 30, 60 (min.)
Background Color	Black, White

6-2-1. LCD brightness

Set the brightness (three stages of bright, middle, and dark) of the LCD backlight.

6-2-2. Screen Saver

Select the time (eight stages of 10 s to 60 min.) you want to specify.

The screen is switched to the Off state automatically when the non-operation state continues for a predetermined period.

Turns off the display if not operated for some time to extend the service life of the LCD screen.

If the GL860 runs on a battery pack (B-573, option), the use of this function prolongs the drive time.

6-2-3. Background Color

Sets the background colors of the waveform display area and the digital display area.

6-3. System settings

Make settings for functions related to system operation.

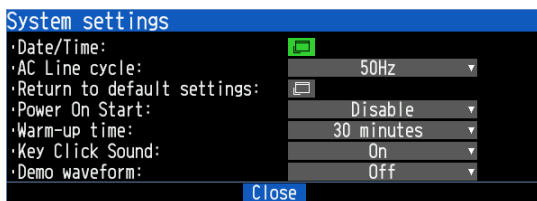

Setting	Selections available	
Date/Time	Date	From 1/1/2024 to 12/31/2035
	Time	From 0:0:0 to 23:59:59
AC Line cycle	50Hz, 60Hz	
Return to default settings	Operation settings	Restore Operation settings
	Communication settings	Restore Communication settings
Power On Start	Disable, Enable	
Warm-up time	Off, 30 minutes, 1 hour, 2 hours	
Key Click Sound	On, Off	
Demo waveform	Off, Sine wave, Triangular wave, Square wave	

6-3-1. Date/Time

Makes settings related to the GL860 clock.
The internal clock (date and time) of the GL860 can be set.

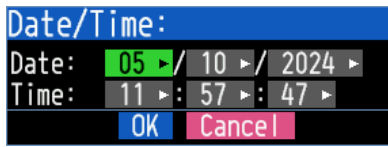

6-3-2. AC Line cycle

Set the frequency of the AC power supply to use.

Selection item	Description
50Hz	For areas where power frequency 50Hz is used
60Hz	For areas where power frequency 60Hz is used

⚠ CAUTION

The frequency set here can be removed by the digital filter.
Note that if you make a mistake in this setting, The GL860 cannot eliminate noise from the power supply.
For the sampling speed at which the digital filter is enabled, refer to "2-1. Sampling Interval" above.

6-3-3. Factory default settings

Initialize the operation settings and communication settings.

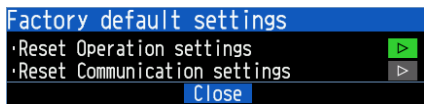

Selection item	Description
Reset Operation settings	Mainly restore amplifier settings, capturing settings, trigger settings, alarm settings and other option settings to the factory settings.
Reset Communication settings	Restore the communication settings to the factory settings.

6-3-4. Power On Start

Set the function to automatically start capturing according to the set conditions when the power is turned on.

Selection item	Description
Enable	Capturing starts automatically when the power is turned on.
Disable	Capturing does not start automatically when the power is turned on.

6-3-5. Warm-up time

This is a function to display the elapsed time since the power was turned on.
When measuring temperature using a thermocouple, the inside of the GL860 must be warmed up sufficiently.
The warm-up time is displayed in the clock display on the upper right of the GL860 at the time set in this setting.



Selection item	Description
Off	The warm-up time is not displayed.
30 minutes	The warm-up time is displayed for 30 minutes after the power is turned on.
1 hour	The warm-up time is displayed for 1 hour after the power is turned on.
2 hours	The warm-up time is displayed for 2 hours after the power is turned on.

6-3-6. Key Click Sound

This function allows you to change the settings for the clicking sound that occurs when you operate the keys.

Selection item	Description
On	Enables a clicking sound when keys are pressed.
Off	Enables no clicking sound when keys are pressed.

6-3-7. Demo Waveform Mode

This parameter displays demo waveforms without analog signal input.

Selection item	Description
Off	The demo waveform is not displayed.
Sine wave	The demo waveform (Sine wave) is displayed.
Triangular wave	The demo waveform (Triangular wave) is displayed.
Square wave	The demo waveform (Square wave) is displayed.

6-4. Language

Set the display language (9 languages Japanese, English (US), English (UK), French, German, Chinese, Korean, Spanish and Russian).

6-5. Navigation function

By following the on-screen instructions, you can set up recording, triggers, wireless LAN, and other settings in wizard format..

Navigation Screen



Setting	Selections available
Easy Capture Settings	Configure the minimum settings required for data recording, such as input settings, sampling settings, and recording destination settings, using a wizard.
Easy Trigger Settings	Trigger settings are configured using a wizard.
Wireless LAN Settings	Wireless LAN connection settings are configured using a wizard.

<Example of operation procedure>

An example of the operation procedure for easy capture setting is described below.

1. Select the “Easy Capture Settings” and then press the [ENTER] key to display the following menu screen.

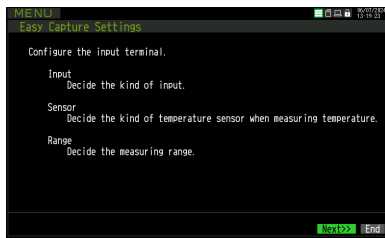

2. When the settings (input, sensor, and range) are satisfied, select the “Next>>” and then press the [ENTER] key. The “Input, Sensor, and Range, etc.” screens are displayed. Set the necessary items.

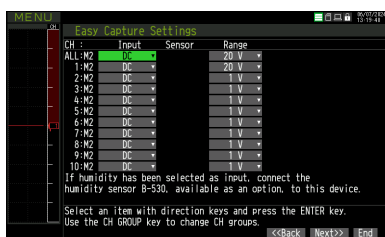

3. After setting, when the “Next>>” is selected and then the [ENTER] key is pressed, the “Sampling, Interval, Capture Destination” screens are displayed. Set the necessary items.

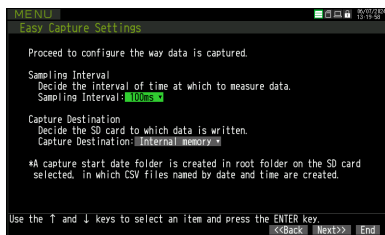

4. After setting, when the “Next >>” is selected and then the [ENTER] key is pressed, the setting information and notes on measurement are displayed.

When the “Finished” is displayed, the operation exits by pressing the [ENTER] key.

When you want to finish the operation in the middle, the operation can be finished by pressing the [NAVI] or [QUIT] key.

The basic workflow to perform “Easy Capture Settings” is as above.

The setting procedure varies depending on the other setting item. However, you can set them by operating in accordance with the instructions displayed on the menu.

6-6. Custom menu

Select the functions to be used with the GL860.

By turning off unused functions, unused functions are not displayed in the Setting Menu, etc.

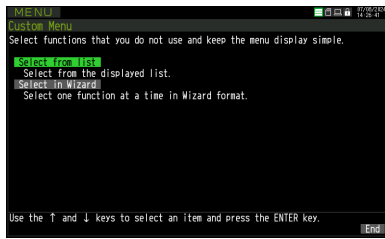

Display item	Description
Select from list	Select the functions you do not want to use from the function list.
Select in Wizard	Select whether or not to use each function while checking the function details for each function.

<Ring capturing function>

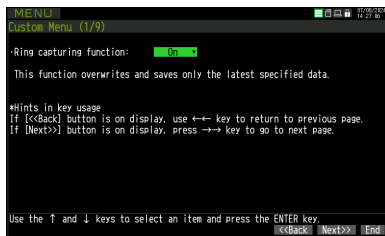

<Relay capturing function>

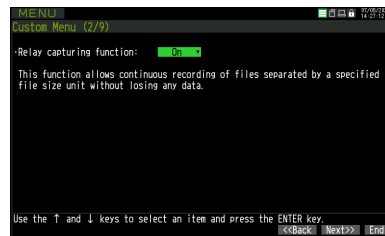

<Backup function>

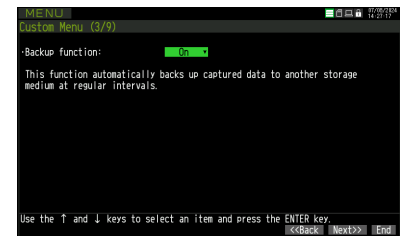

<Trigger function>

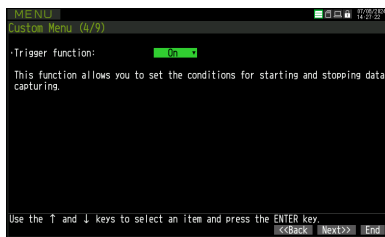

<Alarm function>



<Game>

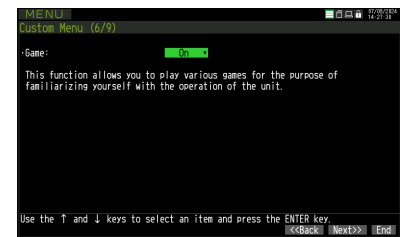

<I/F Command function>



<FTP Server function>



<WEB server function>

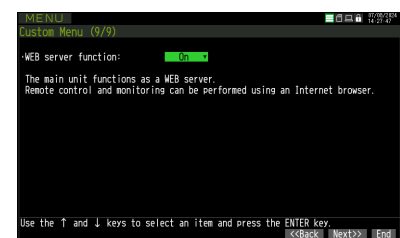

Selection item		Description
Operation settings	Ring capturing function	Select whether to use the ring capturing function. On: Used. Off: Not used. * For the ring capturing function, refer to “2-5. Ring/Relay capturing settings”.
	Relay capturing function	Select whether to use the relay capturing function. On: Used. Off: Not used. * For the relay capturing function, refer to “2-5. Ring/Relay capturing settings”.
	Backup function	Select whether to use the backup function. On: Used. Off: Not used. * For the backup function, refer to “2-6. Backup setting”.
	Trigger function	Select whether to use the trigger function. On: Used. Off: Not used. * For the trigger function, refer to “3. TRIG settings”.
	Alarm function	Select whether to use the alarm function. On: Used. Off: Not used. * For the alarm function, refer to “4. ALARM settings”.
	Game	Select whether to use the game. On: Used. Off: Not used. * For the alarm function, refer to “6-8. Game”.
Communication settings	I/F command function	Select whether to use the I/F command function. On: Used. Off: Not used. * For the trigger function, refer to “5.9. Network settings”.
	FTP server function	Select whether to use the FTP server function. On: Used. Off: Not used. * For the trigger function, refer to “5.9. Network settings”.
	WEB server function	Select whether to use the WEB server function. On: Used. Off: Not used. * For the trigger function, refer to “5.9. Network settings”.

Checkpoint

- This setting is also displayed at the first startup. If you skip the setting at the first startup, the same setting is possible from this setting.
- When any function is turned off, “Displaying custom menu” is displayed on the DATA menu to indicate that the function is restricted.

6-7. Information

Displays system information.

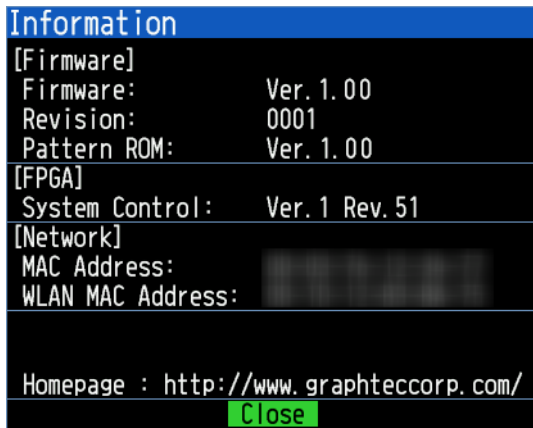

Selection item	Description
Firmware version	The version of the firmware installed in the GL860 is displayed.
Revision	The revision of the firmware installed in the GL860 is displayed.
Pattern ROM version	The revision of the character and image data in the GL860 is displayed.
System Control	The version of the System Control FPGA installed in the GL860 is displayed.
MAC Address	The MAC address of the wired LAN unit installed in GL860 is displayed.
WLAN MAC Address	The MAC address of the wireless LAN unit installed in GL860 is displayed.

6-8. GAME

Various games can be played.

7. Span/Position/Trace settings

When the [ENTER] key is pressed on the waveform display screen during Free-running, capturing, replaying while capturing, or replay, the "Span/Position/Trace" setting screen is displayed.



The span of the active CH that was selected when the [ENTER] key was just pressed is initially selected.

<For Analog, Pulse, Calculation>
Display switching

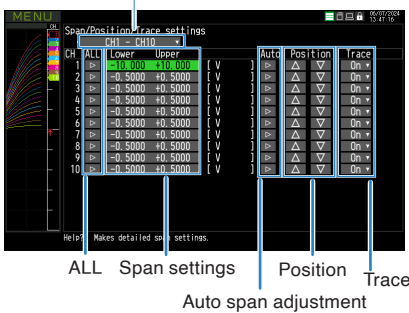

<For Logic>

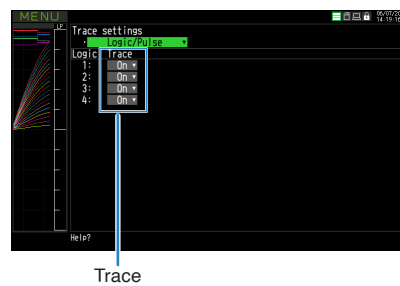

Selection item	Description
Display switching	Switch between analog, logic/pulse, and calculation.
ALL	Execute the batch change mode for settings.
Span settings	Set the upper/lower limit (span) of the waveform display.
Auto span adjustment	Execute the auto span adjustment.
Position	Execute the position move.
Trace	Off, On

7-1. Display switching

Switch between analog, logic/pulse, and calculation.

Analog is always selectable.

Logic/Pulse and calculation cannot be selected unless there is the enabled CH in the settings.

7-2. Span

Make span settings of analog, pulse, and calculation.

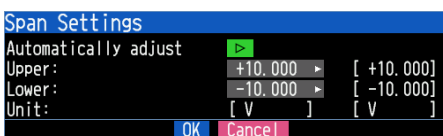

Selection item	Description
Automatically adjust	Automatically adjust the span value based on the displayed data.
Upper limit	Set the span upper limit.
Lower limit	Set the lower span limit.
Unit	Set the unit.

7-3. Auto span adjustment

Automatically adjust the span value based on the displayed data.

7-4. Position

Move the 0 position of the waveform.

By pressing the " Δ " and " ∇ " buttons, the 0 position of the waveform moves by 1 division of the chart grid.

Checkpoint

In practice, the span is adjusted so that the above action is achieved.

7-5. Trace

Set the waveform trace to Off or On.

Trace is a function that switches the waveform display between Off and On. Even if a trace is set to Off, captured data is set to On.

Checkpoint

If you want to set the data to off as well, set "Input" to Off.

7-6. ALL

Move to the batch change mode.

The batch change mode is a mode in which all channels with the same input and range settings and with EU (scaling) set to Off are set to the same value at once.

<Normal mode>

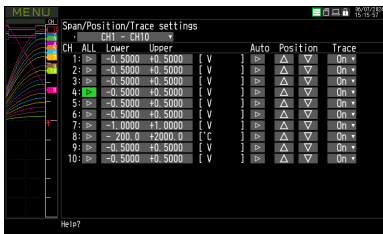

<Batch change mode>

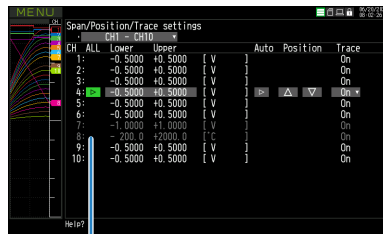

CHs with different settings that cannot be changed all at once are displayed the dark.

<Operation procedure>

1. Press the "ALL" button of the CH that you want to use as the standard for setting.
 - * In the above, CH4 is used as the standard CH.
2. After moving to batch change mode, change the settings you want to change.

When the settings are confirmed, the settings of the CH other than the standard CH are rewritten to the same settings as the standard CH.

* About auto span adjustment

The method of reflecting the span settings other than the standard CH differs depending on whether the auto span adjustment is executed in the span setting dialog or in the batch setting mode display.

Place to execute	Settings reflected
In the span settings dialog	Auto span adjustment of the standard CH is executed. The result of auto adjustment on the standard CH becomes the span value of other CH. The span values of the target channels will all be the same.
In batch setting mode display	Auto span adjustment is executed on all CHs. (Dimmed CHs are not executed.) The span values of the target channels will be the results of automatic adjustment for each channel, and will not be the same span value.

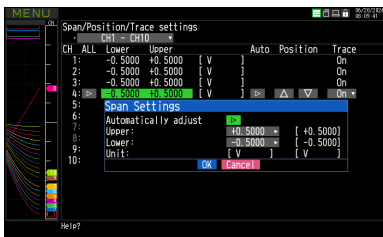

<Batch setting mode display>

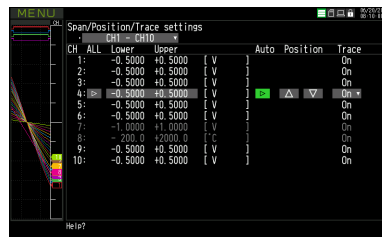

3. Press the "ALL" button again to return to normal mode.

8. FILE menu

The file operations can be performed by pressing the [FILE] key.

The display items vary depending on the operation mode of free-running, replaying, and capturing.

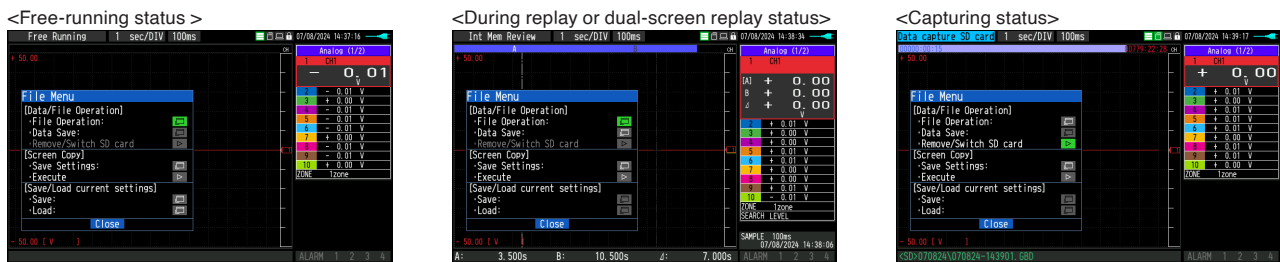

8.1 File Operation

In Free Running and operation modes during replaying, the files in the internal memory or SD memory card can be manipulated.

Select the File operation and press the [ENTER] key to open the file dialog (file list).

You can select a file by moving the cursor on a folder or file and pressing the [ENTER] key.

(An "x" mark appears to the left of the file name. Press the [ENTER] key again to cancel the selection.)

This operation is mainly used for selecting multiple files.

You can also select continuously by pressing the Up or Down keys while holding down the [ENTER] key.

If you select the file or the folder and press the [MENU] key, you can select the following operations.

Checkpoint

When operating a single folder or file, you can select the following operations simply by moving the cursor and pressing the [MENU] key. In this case, there is no need to use the [ENTER] key to select a file.

<Route display>

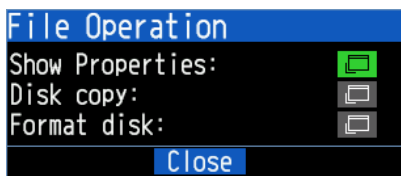

Operation mode	Description
Show Properties	The detailed disk information (drive name, file system, free space, total capacity, volume name) is displayed.
Disk copy	Copy the disk. Select a destination (another disk), and execute the disk copy.
Format disk	Initialize the internal memory or SD CARD.

<Display other than root>

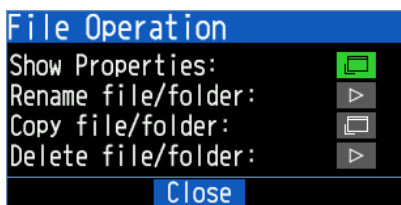

Operation mode	Description
Show Properties	The detailed information (file name, date, time) of the file or folder is displayed. For GBD and CSV files, replay operations are also possible.
Rename file/folder	Rename the file or folder. You can select the file or folder and rename it. Refer to "10. Text input" and operate.
Copy file/folder	Copy the file or folder. Select the copy destination (another folder, etc.), and execute the file copy.
Deletion file/folder	Delete a file or folder.

<Example of operation procedure>

Example of file/folder delete procedure is described.

1. Select the file/folder you want to delete.

Move the cursor to the file or folder to be deleted in the file list and press the [ENTER] key to display the "X" mark.
(Multiple selection possible)

Press the [ENTER] key again to cancel it. When it is cancelled, the "X" mark will disappear.

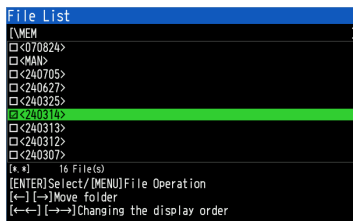

2. Execute the deletion.

When you select "Files/folders deletion" from File operation, the "[** files/folders are selected] Delete the file. All the data will be lostAre you sure?" message is displayed.

Press the [ENTER] key to delete the selected data.

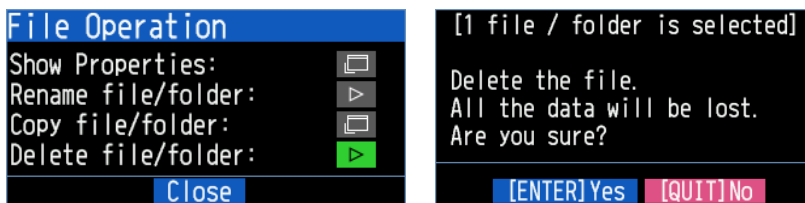

An example of copying a file/folder is described.

1. Select the files/folders you want to copy.

Move the cursor to the file or folder to be copied in the file list and press the [ENTER] key to display the "x" mark.
(Multiple selection possible)

To deselect, press the [ENTER] key again. It is canceled when the "X" mark disappears.

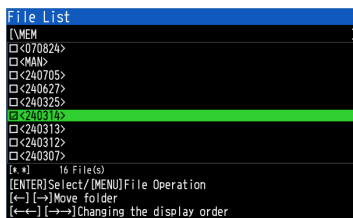

2. Specify the copy destination.

When you select "File/Folder copy" from the File operation, the copy destination selection/execution screen is displayed. Press the "<" and ">" keys to specify the copy destination folder. In this example, to set the copy destination to the SD CARD, press the "<" key to return to the root, select SD on the root screen and press the ">" key.

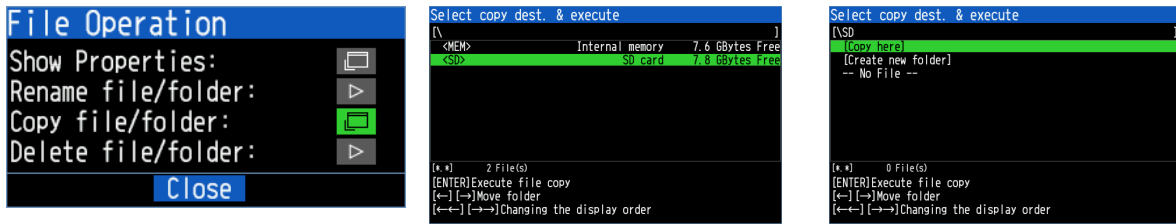

3. Execute the copy.

Move the cursor to "Copy here" in the Copy destination select/execute dialog and press the [ENTER] key to copy. "Are you sure?" is displayed. Press the [ENTER] key to copy the file.

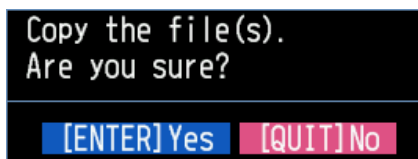

8-2. Data Save

During replaying the data, the displayed data can be saved in the internal memory or SD memory card by selecting the Data Save in the File Menu.

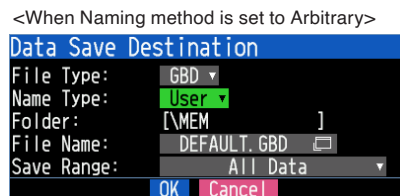
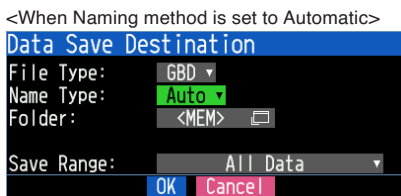
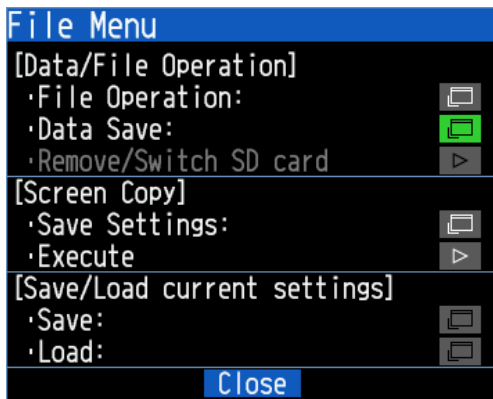

Setting	Description
File Type	Sets the file format used to save data. GBD: Creating a data file in Graphtec's proprietary binary format. * Data tampering can be prevented. CSV: Creating a data file in text format.
Name Type	Sets how a data file should be named. Auto: Automatically supplies the file name. <Example> 20240601-123456.GBD Number part: File creation date * The file is created on June 1, 2024, 12:34:56 in this example. GBD : Data format User: Data is captured to a file with an entered file name. Sequential number: A file is created with an arbitrary file name that has been entered, followed by a sequential number.
Folder	Specify a folder to which you want to capture (or save) data. For details, refer to "9. File dialog".
Save Range	Set the data range to be saved. All data: All of the data is saved regardless of the cursor operation. Between Cursors Data: Only the data in the range between cursors A and B is saved.
File Name	Specify a folder to which you want to capture (or save) data. For details, refer to "9. File dialog".

8-3. Remove/replace SD memory card

The SD memory card (SD) can be replaced during saving the data in the SD memory card. Perform the card replacement according to the following procedure

1. Press the "FILE" key to open the FILE menu.
2. Press the [ENTER] key in the "Remove/Switch SD card".

<File menu>

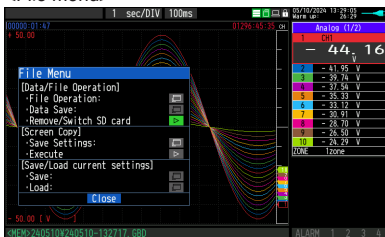

<Removing/replacing the SD CARD>

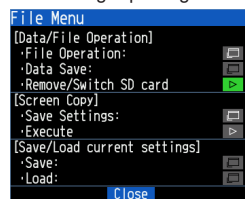

3. Make sure that the message is displayed and then remove the SD memory card.

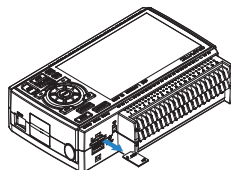
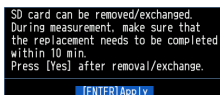

Capturing destination	Backup destination	Other conditions	SD CARD replacement
Internal memory	None		Not applicable
	SD CARD		Replaceable (Backup side)
		When ring capturing is enabled.	Impossible
		When external sampling is set.	Impossible
	The capturing format is CSV.	Impossible	
FTP server (Wireless LAN)			Not applicable
FTP server (Wired LAN)			Not applicable

Capturing destination	Backup destination	Other conditions	SD CARD replacement	
SD CARD	None		Replaceable (Capturing side)	
		When ring capturing is enabled.	Impossible	
		When external sampling is set.	Impossible	
	Internal memory			Replaceable (Capturing side)
		When ring capturing is enabled.	Impossible	
		When external sampling is set.	Impossible	
		The capturing format is CSV.	Impossible	
	FTP server (Wireless LAN)			Not applicable
FTP server (Wired LAN)			Impossible	

CAUTION

Please perform the replacement operation within the displayed time in the message.
 When the backup is performing for the CSV Format, the SD-Memory Card can not exchange.

Checkpoint

Every time you replace the SD memory card, “_CHG” number is added to the file name.
 <Example> When the data is captured in the file name “TEST.GBD”
 First SD memory card: TEST.GBD Second SD memory card: TEST_CHG1.GBD

8-4. Specify Save Destination (Screen Copy)

Saves the data that is replaying on the screen in the internal memory or SD memory card as an image file.

<If the naming method is Auto>



<If the naming method is Arbitrary>

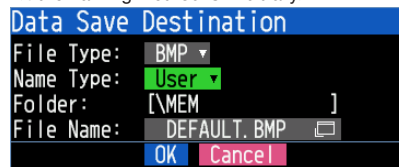

Setting	Description
File Type	Sets the file format used to save data. BMP: Saves data in bitmap file format PNG: Saves data in ping format
Name Type	Set how a data file should be named. Auto: Automatically supplies the file name. <Example> 20240601-123456.BMP Number part: File creation date * The file is created on June 1,2024,12:34:56 in this example. BMP: Data format BMP (BMP file format) PNG (PNG file format) User: Data is captured to a file with an entered file name. Sequential number: A file is created with an arbitrary file name that has been entered, followed by a sequential number.
Folder	Specify a folder to which you want to save data. For details, refer to "9. File dialog".
File Name	Specify a file to which you want to save data. For details, refer to "9. File dialog".

8-5. Execute (Screen Copy)

Executes screen copy and saves it to an image file. Refer to page "8-4. Specify Save Destination (Screen Copy)" for details on specifying the save destination.

8-6. Save

Saves the setting conditions of the GL860.

<If the naming method is Auto>

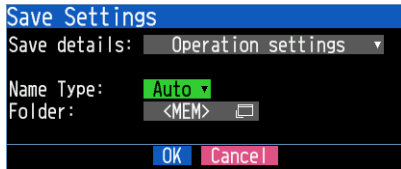

<If the naming method is Arbitrary>

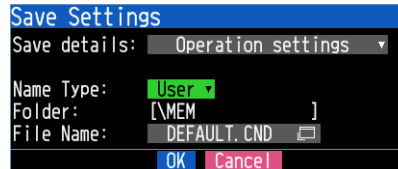

Setting	Description
Save details	Set the details of the saved data setting. Operation setting: Settings related to the operation of this device are saved. Communication setting: Settings related to the communication are saved.
Name Type	Set how a data file should be named. Auto : Automatically supplies the file name. <Example> 20240601-123456.CND Number part: File creation date * The file is created on June 1,2024,12:34:56 in this example. CND: Data format CND: This is the operation setting file format of the GL860. NCD: This is the communication setting file format of the GL860. User: Data is captured to a file with an entered file name. Sequential number: A file is created with an arbitrary file name that has been entered, followed by a sequential number.
Folder	Specify a folder to which you want to save data. For details, refer to "9. File dialog".
File Name	Specify a file to which you want to save data. For details, refer to "9. File dialog".

8-7. Load Settings

Loads and reflects the GL860 setting conditions from a file.

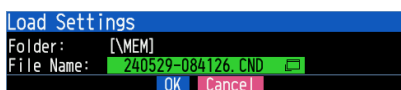

Setting	Description
Folder	The folder of the file specified in the FILE is displayed. Specify a folder to which you want to save data. For details, refer to "9. File dialog".
File Name	Specify a file to which you want to save data. For details, refer to "9. File dialog".

9. File dialog

This section describes how to specify the data save destination in the DATA menu, how to specify the data save destination in the FILE menu, and how to operate the file list.

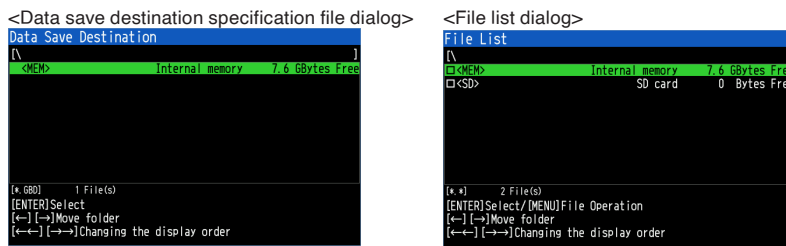

Key	Description
◀▶	Moves between folders. ◀ : Move up one folder. ▶ : Move down one folder.
◀◀ ▶▶	The display order can be changed.
ENTER	When setting the save destination, etc., select and confirm the file/folder. In addition, when making file operations, check the check box.
MENU	When you operate a file, the File operation dialog opens. For details, refer to "8. File menu".
QUIT	Close the file dialog.

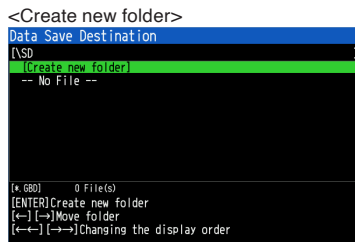

When making the settings such as the save destination, you can create a new folder and file. Select "Create new folder" or "Create new file" from the destination list and press the [ENTER] key.

<Example of operation procedure>

The following shows an operation example where a folder named "TEST" is created for captured data and automatically saved.

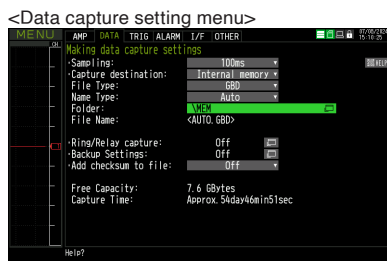

1. Select the DATA menu.
2. In the Capturing setting menu, set the file format to GBD and the naming method to Automatic.
3. Then, open the data saving destination menu by pressing the [ENTER] key on the "FOLDER" to specify a data saving destination and create a folder.
4. Create a "New folder" in the file dialog.
* For the creation of a new folder, refer to "10. Text input" described below.
5. Select the folder you created and press the [ENTER] key.

10. Text input

Related to text input operations such as annotation, EU (scaling) unit and captured data file name input.

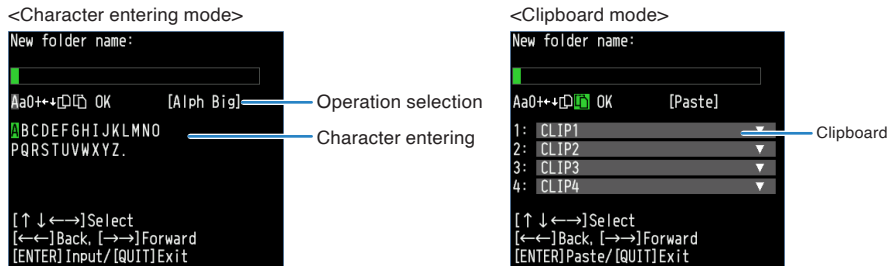

Operation mode	Description	Operation method
Text input	A	Upper case alphabet mode
	a	Lower case alphabet mode
	0	Numeric mode
	+	Symbol mode
	←	Delete mode
	↓	Insert mode
		Copy mode
	Paste mode	Paste the contents of the clipboard. Confirm the content to be pasted with the "▽" key and paste it with the [ENTER] key.
OK	Finalize mode	Confirm the entered character string with the [ENTER] key.
Character entering	Each input character type is displayed.	Move the cursor to a character and press the [ENTER] key to enter the character. After entering all the characters, move to the OK icon and press the [ENTER] key.
Clipboard	The contents of the clipboard are displayed.	In copy mode, the contents of the clipboard are displayed. In paste mode, you can select and paste the clipboard with the "△▽" key. In either mode, you can edit the contents of the clipboard by pressing the "▽" key.

<Setting example>

Example of operation procedure to enter the "TEST01" to create the new file name is described

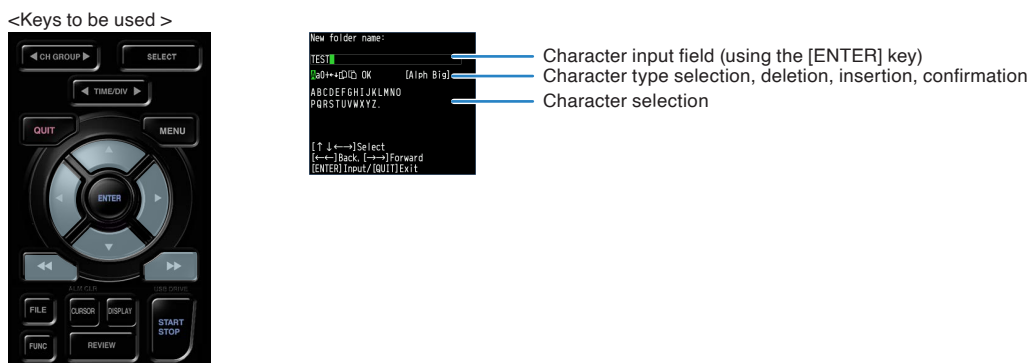

1. Set "Character type selection" to "A" (Uppercase alphabet mode).
2. Select "T", "E", "S" and "T" in order in "Character selection".
3. Set "Character type selection" to "0" (Number mode).
4. Select the numbers "0" and "1" in order in "Character selection".
If you make a mistake when entering a character, use the "◀◀ ▶▶" keys to move the cursor to the character you want to delete, and then select the "←" (delete mode) in "Character type selection" and press the [ENTER] key.
One character will be deleted.
5. After confirming the entered characters, set "Character type selection" to "OK" (confirmation mode) and press the [ENTER] key to confirm the entered character.

Checkpoint

If the display language is other than "Japanese", half-width kana mode cannot be used in "2. Character type selection".

10-1. Clipboard

The clipboard is a function that allows you to store the character string that you have entered once and enter the same character string repeatedly.

For example, if the CH annotation looks like this, there is a common character string.

CH	Contents of the annotation
CH1	Channel Annotation CH1
CH2	Channel Annotation CH2
CH3	Channel Annotation CH3

In this case, the "Channel Annotation CH" part is common.

By storing this common part in the clipboard, you can input repeatedly with a few steps.

The clipboard can store 4 types of character strings (Up to 64 characters per type).

Checkpoint

The contents of the clipboard are lost when the power is turned off. Use it as a temporary memory.

You can also edit the stored character strings.

Select the "▽" key on the right side of the character string in the clipboard you want to edit.

<Example of copy/paste operation>

1. Open the annotation settings of CH1 and enter the character string you want to copy to the clipboard in the character input field.

In the above example, enter "Channel Annotation CH".

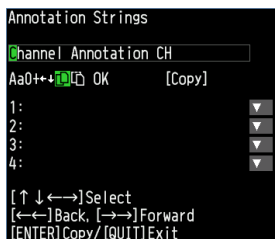

2. Select "OK" and press the [ENTER] key.

The character string entered in the character string entering field is copied to No. 1 of the clipboard.

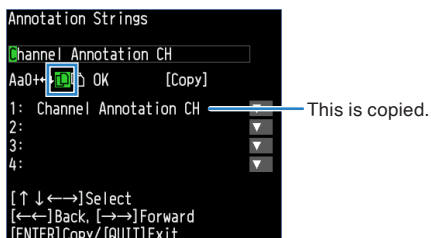

3. Enter the rest of the character string and select "OK" to complete the settings.
4. Open annotation settings for CH2.

5. Select the " " and use the "▽" key to select the character string you want to paste from the clipboard.

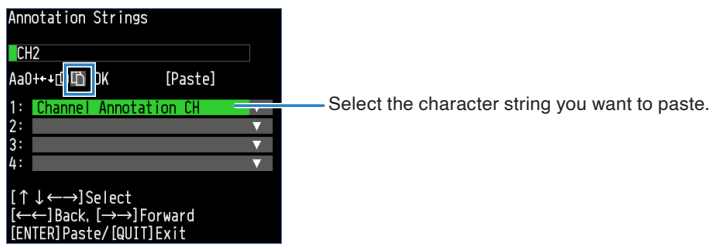

6. Paste by pressing the "ENTER" key.

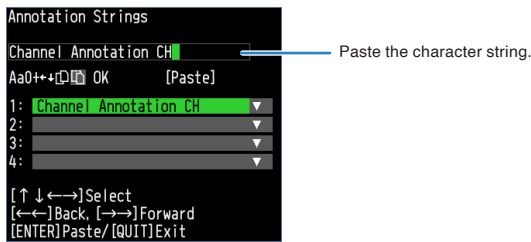

7. Enter the rest of the character string and select "OK" to complete the settings.

10.2 Clipboard copy operation

When copying to the clipboard, the four clipboard strings are as follows.

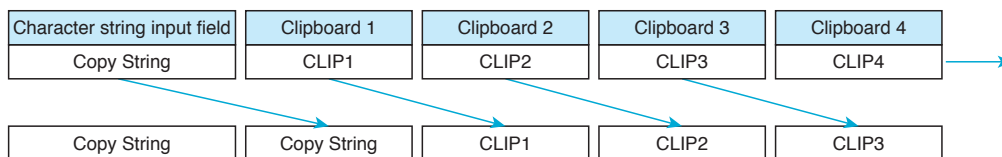

1. The character string in clipboard 4 is discarded.
2. The character string in clipboard 3 is copied to clipboard 4.
3. The character string in clipboard 2 is copied to clipboard 3.
4. The character string in clipboard 1 is copied to clipboard 2.
5. The character string in the character string input field is copied to clipboard 1.

* If the number of characters in the character string input field exceeds 64 characters, the previous 64 characters are copied.

Checkpoint

Copying is subject to the following conditions.

- If the character string input field is blank, it is not copied.
- Blanks at the end of the character string input field are not copied.
- If clipboards 1 to 4 contain the same character string as the character string input field, it is not copied.

11. Data replay menu

Select the data you want to replay from the "Data replay source" by pressing the [REVIEW] key and replay the captured data.

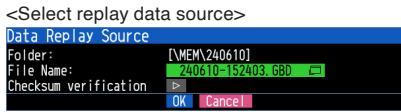

Select items	Description
File	Specify the file in the capture destination (save destination).
Check data corruption	Check if the captured file is damaged. The data corruption results are displayed in a dialog. When the data is not corrupted: "Data is not corrupted" is displayed. When the data is corrupted: "Data is corrupted" is displayed.

CAUTION

For CSV-formatted data, only the data captured by this GL860 can be replayed.
"Checksum verification" is displayed only when selecting a GBD file to which a checksum is attached.
For how to add checksums, refer to "2-7. Data corruption check function" in "2. DATA settings".

<When using the replay data and cursor A>

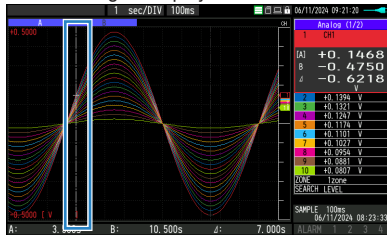

Cursor A

<When using the replay data and cursor B>

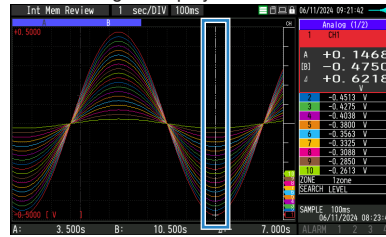

Cursor B

Pressing the [MENU] key during capturing/replaying displays the Replaying menu.

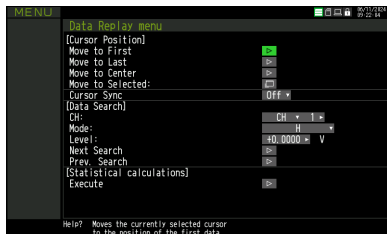

Setting		Selections available		
Cursor Position	Move to First	Select \triangleright and press the ENTER key to execute.		
	Move to Last	Select \triangleright and press the ENTER key to execute.		
	Move to Center	Select \triangleright and press the ENTER key to execute.		
	Move to Selected	Method:	Position, Time	
		Position	Position	0 to end of data For example, if the sampling interval is 100 ms, the capture destination is the built-in RAM, and the number of capture points is 10000, settings up to 999.9ms are available.
		Time	Date	Date from the start to the end of the data
		Time	Time from the start to the end of the data	
	Cursor Synch	Off, On		

Setting		Selections available	
Data search	CH		CH1 to 200, Logic, Pulse, Alarm, CALC * Logic and Pulse are displayed only if the Logic Pulse function is On in the AMP settings. *CALC is displayed only if the Calculation function is On in the AMP settings.
		CH1 to CH200	CH1-200
		Logic	Logic1-4
		Pulse	Pulse1-4
		Alarm	Alarm1-4
		CALC	CALC1-20
Data search	Mode	CH1 to CH200	↑ H, ↓ L
		Logic	↑ H, ↓ L
		Pulse	↑ H, ↓ L
		Alarm	Both, ↑ H, ↓ L
		CALC	↑ H, ↓ L
	Level	CH1 to CH200	Set numeric value
		Pulse	Set numeric value
		CALC	Set numeric value
	Next Search		Select ▷ and press the ENTER key to execute.
	Prev. Search		Select ▷ and press the ENTER key to execute.
Statistical calculations	Execute	Select ▷ and press the ENTER key to execute.	

11-1. Move to First Data

Executing this option moves the currently selected cursor (A or B) to the start of the data.

11-2. Move to Last Data

Executing this option moves the currently selected cursor (A or B) to the end of the data.

11-3. Move to Center

Executing this option moves the currently selected cursor (A or B) to the center of the data.

11-4. Move to Selected Position

Sets a position (relative position in time) or time and moves the currently selected cursor (A or B) to this position or time.

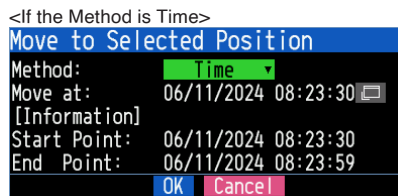
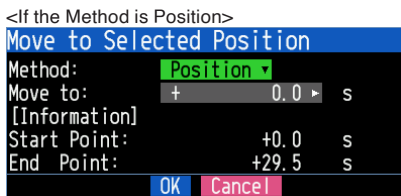

Setting	Selections available
Method	Sets the method for specifying the position to move the cursor. Select Position or Time.
Move to	Sets the position to move the cursor. The cursor can be set from the capture start position assumed as the Start Point 0s up to the endpoint value.
Move at	Sets the date and time to move the cursor. The cursor can be set from the capture start position assumed as the Start Point date/time up to the endpoint value.

11-5. Cursor Sync

Sets up the function that moves two cursors in synchronization.

Selection item	Description
Off	Cursors are not synchronized. Only the specified one cursor moves.
On	Two cursors move in synchronization. Cursor A is always the fulcrum.

* Cursor Synch is turned Off when you move a cursor using Move to Selected Position or perform Data Search.

11-6. Date Search

Sets the search conditions to be used in the next sections ("11-7. Find Next" and "11-8. Find Previous").
The operation is an Edge operation.

Selection item	Description
CH	Sets the channel to be used for search. CH1-200: The specified analog channel is used for search. Logic1-4: The specified logic channel is used for search. Pulse1-4: The specified pulse channel is used for search. Alarm1-4: The specified alarm output is used for search. CALC1-20: The specified calculation channel is used for the search.
Mode	Sets the search mode. Both: Detects an edge at which alarm output changes from generation to cancellation or vice versa when Alarm or CALC is selected. ↑ H: Detects a rising edge of an analog signal or an edge at which CH alarm output changes from cancellation to generation ↓ L: Detects a falling edge of an analog signal or an edge at which CH alarm output changes from generation to cancellation.
Level	Sets a voltage level and pulse level to be searched for when the search channel is an analog or pulse channel.

11-7. Next Search

Executing this option moves the cursor to the next position where the search conditions are met, down from the current cursor position. (Specify the search conditions as described in "11-6. Data Search".)

11-8. Previous Search

Executing this option moves the cursor to a previous position where the search conditions are met, up from the current cursor position. (Specify the search conditions as described in "11-6. Data Search".)

11-9. Execution (Statistical operation between cursors)

Executes calculation between cursors. Executing this option opens a window to display calculation results. For a description of the calculation results, see the table below. Pressing the [FILE] key opens a window for saving statistical calculation results. Specify a save destination and select OK to save statistical calculation results in text (CSV) format.

* The specifying method of storage location and file name is the same as the file specifying method of captured data. For details, refer to "9. File dialog" described above.

* The "CH GROUP" key is active. CH11 and onwards can be viewed by pressing the [CH GROUP] key.

CH	Average	Max	Min	p-p	RMS
1	+0.0989	+0.4750	-0.4750	+0.9500	+0.3469
2	+0.0939	+0.4512	-0.4512	+0.9025	+0.3295
3	+0.0890	+0.4275	-0.4275	+0.8550	+0.3122
4	+0.0840	+0.4037	-0.4037	+0.8075	+0.2948
5	+0.0791	+0.3800	-0.3800	+0.7600	+0.2775
6	+0.0741	+0.3562	-0.3562	+0.7125	+0.2601
7	+0.0692	+0.3325	-0.3325	+0.6650	+0.2428
8	+0.0642	+0.3087	-0.3087	+0.6175	+0.2254
9	+0.0593	+0.2850	-0.2850	+0.5700	+0.2081
10	+0.0543	+0.2612	-0.2612	+0.5225	+0.1907

Select [FILE] to save CSV / [QUIT] to return

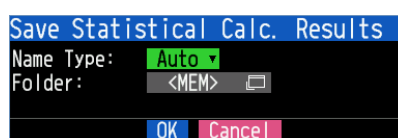

Selection item	Description
Average	Displays the simple average value of the data between cursors A and B.
Max	Displays the maximum value of the data between cursors A and B.
Min	Displays the minimum value of the data between cursors A and B.
P-P	Displays the peak to peak (P-P) value of the data between cursors A and B.
RMS	Displays the RMS value of the data between cursors A and B. The calculation formula is as follows: $\text{R.M.S} = \sqrt{\sum D^2/n}$ * D: data n: number of data

12. Quick setting

<Free Running>

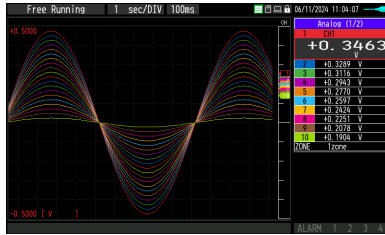

<Replay data>

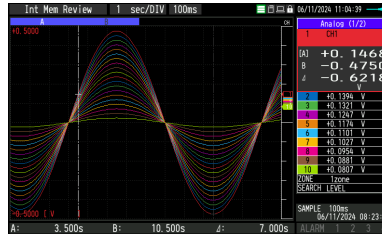

Screen	Operation mode	Sign	Description
Waveform	Free Running	ZONE	Using the <D> key, change the zone division.
	Capturing	ZONE	Using the <D> key, change the zone division.
	Replaying during capture	ZONE	Using the <D> key, change the zone division.
		SEARCH	Using the <D> key, perform the search. <D: Search the past waveform. >D: Search the future waveform.
	Replaying	ZONE	Using the <D> key, change the zone division.
		SEARCH	Using the <D> key, perform the search. <D: Search the past waveform. >D: Search the future waveform.

12-1. ZONE

The waveform display can be switched to 1, 2, 5 or 10-divided display.

1-divided: 10ch full scale display

2-divided: The display is divided into two screens. 1, 3, 5, 7, 9-ch and 2, 4, 6, 8, 10-ch are displayed in the 2-divided screens separately.

5-divided: The display is divided into five screens. 1/6ch, 2/7ch, 3/8ch, 4/9ch, 5/10ch are displayed in the 5-divided screens separately.

10-divided: The display is divided into ten screens. Each channel is displayed in a single screen separately.

12-2. SEARCH

Search the alarm generated position in the replayed data.

For details, refer to "11-6. Data search" in "11. Data replaying menu".

13. To cancel key lock by password

A password can be set to GL860 to cancel the key lock.
(No password is set at factory default.)

<Operation flow>

1. Set the password.

Press the "◀▶", and [ENTER] keys at the same time to display the password setting screen shown below.
Specify a 4-digit password.



Use the "△▽◀▶" keys to select numbers. Press the [ENTER] key to confirm the password.
Specifying 0000 will disable password operation.
In case you forgot your password, please contact us to acquire the master password.

2. Set the password.

Hold down the "◀◀" and "▶▶" keys together for at least two seconds.

3. Cancel the key lock.

Hold down the "◀◀" and "▶▶" keys together again for at least two seconds.

The password setting screen shown below will be displayed. Set a password.



Entering an incorrect password will not cancel the key lock.
The key lock state will be retained when power is turned off.

14. QR code

Click the "HELP" mark icon in the menu of the GL860 to display the QR code.

This QR code allows you to access the FAQ Q&A on our website.

If you have any problems, read the QR code with your smartphone, etc., and check the Q&A on our website.

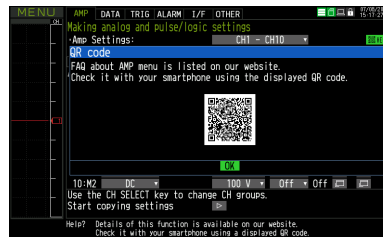
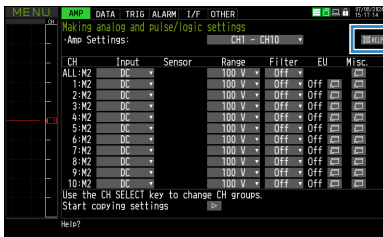

3.5 WEB Server Function

The web browser allows operating and monitoring GL860 through an optional wireless LAN unit.

- Supported Web browsers
 - Google Chrome (recommended)
 - Microsoft Edge
 - Firefox

*The web server function may not work properly if your web browser is updated. If this happens, try using a different web browser.
- Available functions using a Web browser
 - Monitoring and operation of the GL860
 - Download files in the GL860
- Setting the URL

The URL (Uniform Resource Locator) must be correctly set according to your network environment.
When the port number is changed, enter the following:
http://IPaddress: Port number/index.html

 - http..... Protocol to access the server.
 - IP address..... Enter the IP address of the GL860 to monitor.
 - Port number Specify the port number.
The port number is the number set to the GL860 or router, etc.
 - Index.html This is the file name. This file name is fixed to index.html.

Checkpoint

- The port number can be omitted. In this case, the port number is 80.
http://(IPaddress): 80/index.html
- It is not possible to simultaneously WEB connection from multiple browsers.
Please use a single browser for one GL860 main unit.

<Procedure>

1. Open the Web browser.

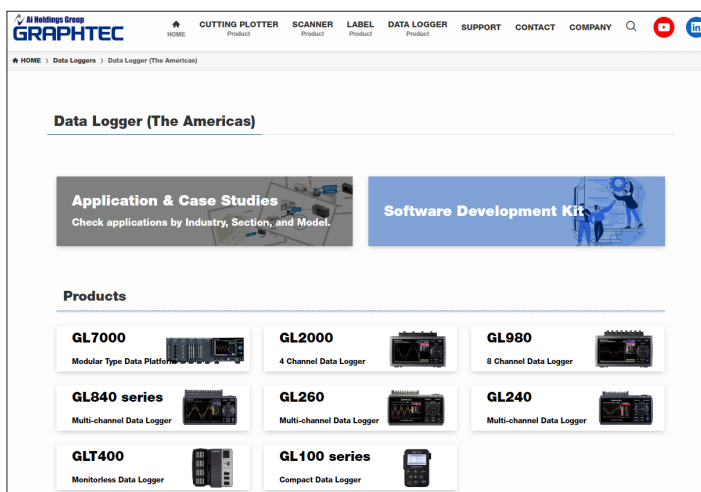

2. Type in the URL (http://IP address/Index.html) in the address input field.

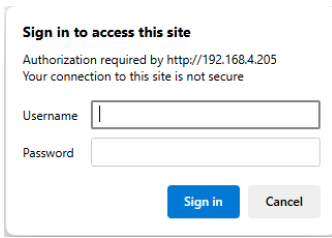

3. The following pages are displayed.

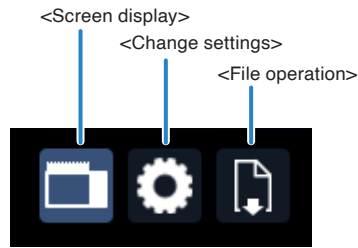
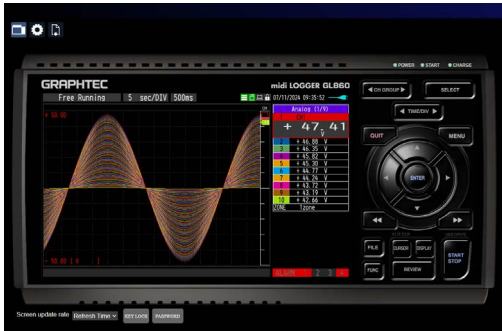

Screen displayAllows GL860 operation.

Change settingsYou can check and change the settings of the GL860.

File operationThe data captured by GL860 can be downloaded to/deleted from the PC.

CAUTION

You may not be able to access the web page if you change the network or restart.

Screen display

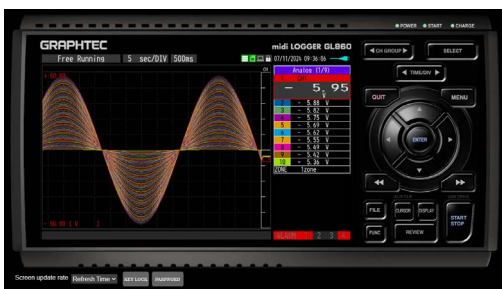

KEY LOCK Sets and cancels key lock.

PASSWORD Sets and cancels a password.

Screen update rate ... Sets an update rate of the screen.

The screen update speed can be set to real-time, 1, 3, or 5 seconds.

Change settings

AMP settings

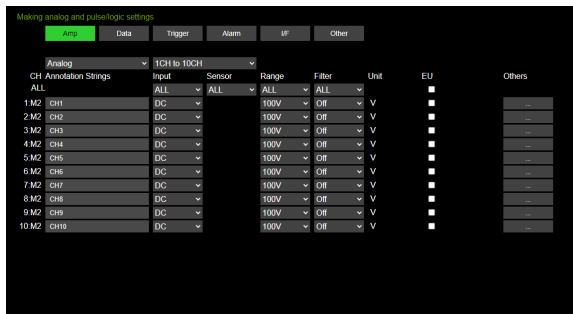

DATA settings

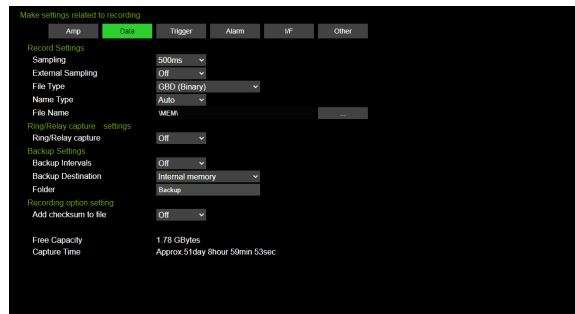

TRIGGER settings

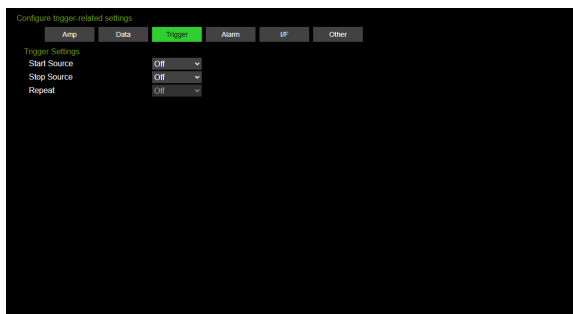

ALARM settings



I/F settings

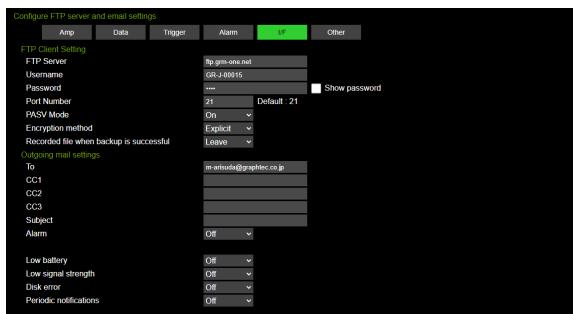

OTHER settings

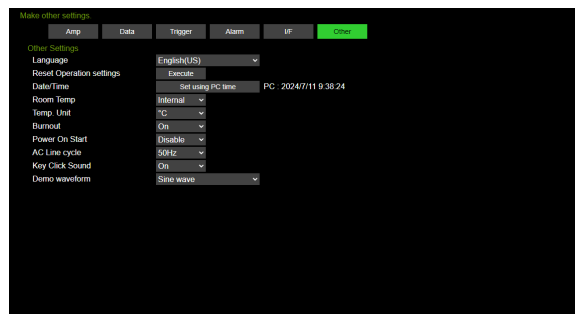

AMP settings Make Analog input, Pulse, Logic and Calculation settings.

DATA settings Make settings related to capturing.

TRIGGER settings Make settings related to the trigger.

ALARM settings..... Make settings related to the alarm.

I/F settings Make settings related to FTP client and mail.

OTHER settings Make other settings.

* Some settings cannot be changed from the web browser.

File operation

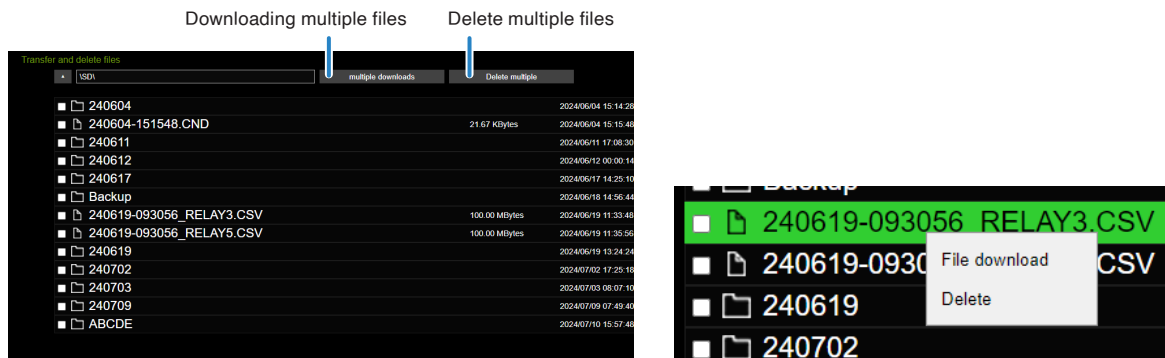

Folder/file display By double-clicking the folder, you can display the files in the folder.
Double-click the file to download the file.

Download.....By right-clicking the file/folder and selecting "Download", you can download the file.
If you select a folder, all files in the folder are downloaded.

Delete You can delete a file/folder by right-clicking on the file/folder and selecting "Delete".

Download multiple files... You can download all the checked files/folders at once.
If you select a folder, all files in the folder are downloaded.

Delete multiple files You can delete the checked files/folders at once.

* The file is downloaded to the download destination of the browser.

* When you select a folder, only the files in the folder are downloaded. No folder is created.

* Files that are being recorded will not be displayed. It cannot be deleted or downloaded.

3.6 List of Error Codes

If an error code is displayed on the GL860, please handle errors in reference to the table below.

Error code	Description
-1	Please contact us.
1	Please contact us.
2	File not found. The operation target is not a folder.
3	Hardware error There is a possibility that the hardware has failed. Please contact us.
5	There is a possibility that the internal memory or SD memory card has failed.
8	Please contact us.
9	Please contact us.
12	Please contact us.
13	It is write-protected. Please check the write-protect switch of the SD memory card.
16	Please contact us.
17	File/folder already exists. The error code is displayed when you create a folder with the folder name that already exists.
21	The target is not a file. You tried to perform the file operation for a folder.
22	The path name is too long.
23	Please contact us.
24	Please contact us.
27	Please contact us.
28	Please contact us.
46	Please contact us.
88	The disk format is not supported.
90	The target directory is not empty.
100	Please contact us.
101	Please contact us.
102	Please contact us.

Chapter 4 Example of Use

This chapter provides simple examples of how to use the GL860.

SECTION IN THIS CHAPTER

- 4.1 *Capturing procedure*
- 4.2 *Replay procedure*
- 4.3 *Other functions*

4.1 Capturing procedure

We briefly describe the preparation, setup and capturing procedures for data capturing. Here we take voltage and temperature measurements as an example.

Item	Description
Capturing purpose	Voltage and temperature measurement of a target object
Target measuring point	2 points
Thermocouple	T-type thermocouple, 100°C
Voltage range	1V
Sampling interval	1 second
Data saving destination	Internal memory (MEM)
Trigger	This is not used.

1. Preparation

Prepare for capturing.

1. Connect measurement object 1 to the 1CH terminal. (Voltage)
2. Connect measurement object 2 to the 2CH terminal. (Temperature)
3. Connect to AC power.
4. Turn on the power.

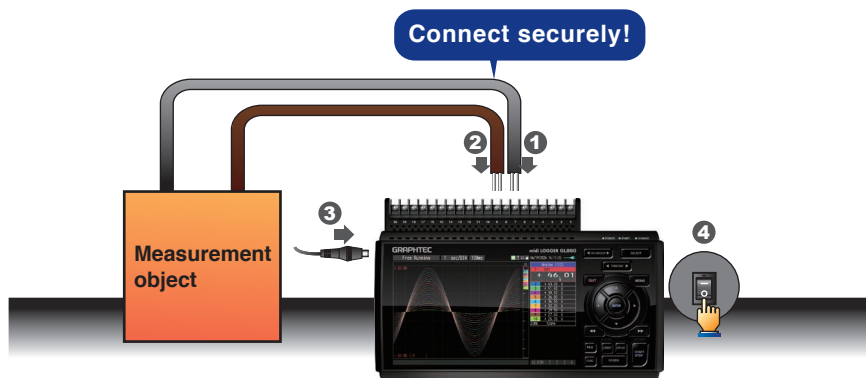

5. Wait at least 30 minutes for the GL860 to warm up.
(Warm-up is required when performing thermocouple measurements.)

2. Settings

Only the settings necessary for capturing are made here. Use the default settings (factory settings) for other settings.

The basic operation of the setting menu

On the menu screen, use the " $\Delta \nabla \triangleleft \triangleright$ " keys, "ENTER" key, and "QUIT" key to operate.

The current cursor position is displayed in "green". When you want to move, use the " $\Delta \nabla \triangleleft \triangleright$ " keys. By pressing the "ENTER" key at the cursor position, the select menu, numeric input menu, character string input menu, etc. are displayed. By pressing the "QUIT" key, you can close the screen or cancel the setting.

Example of select menu operation

We explain how to operate the select menu on the AMP setting screen.

1. Press the "MENU" key once in the free-running state to open the AMP setting screen.

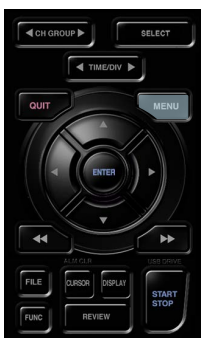

CH	Input	Sensor	Range
ALL:M2	DC		1 V
1:M2	DC		1 V
2:M2	DC		1 V
3:M2	DC		1 V
4:M2	DC		1 V
5:M2	DC		1 V

2. Use the " $\Delta \nabla \triangleleft \triangleright$ " keys to move the cursor to the CH1 input.



CH	Input	Sensor	Range
ALL:M2	DC		1 V
1:M2	DC		1 V
2:M2	DC		1 V
3:M2	DC		1 V
4:M2	DC		1 V
5:M2	DC		1 V

3. Press the "ENTER" key to display the select menu.

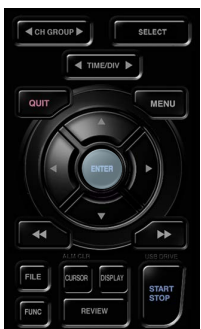

CH	Input	Sensor	Range
ALL:M2	DC		1 V
1:M2	DC		1 V
2:M2	Off		1 V
3:M2	DC		1 V
4:M2	TEMP		1 V
5:M2	RH		1 V

Select menu

4. Select the temperature with the " Δ ∇ \langle \rangle " keys.



CH	Input	Sensor	Range
ALL:M2	DC		1 V
1:M2	DC		1 V
2:M2	Off		1 V
3:M2	DC		1 V
4:M2	TEMP		1 V
5:M2	RH		1 V

5. Press the "ENTER" key to confirm.



CH	Input	Sensor	Range
ALL:M2	TEMP	TC-K	2000 °C
1:M2	TEMP	TC-K	2000 °C
2:M2	DC		1 V
3:M2	DC		1 V
4:M2	DC		1 V
5:M2	DC		1 V

AMP settings

Make input settings for CH1 and CH2.

Press the "MENU" key to open the AMP setting screen.

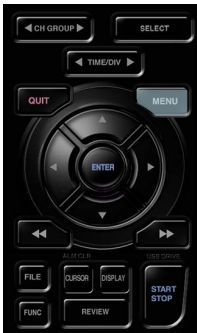

CH	Input	Sensor	Range	Filter	EU	Misc.
ALL:M2	DC		100 V	Off		
1:M2	DC		100 V	Off	Off	
2:M2	DC		100 V	Off	Off	
3:M2	DC		100 V	Off	Off	
4:M2	DC		100 V	Off	Off	
5:M2	DC		100 V	Off	Off	
6:M2	DC		100 V	Off	Off	
7:M2	DC		100 V	Off	Off	
8:M2	DC		100 V	Off	Off	
9:M2	DC		100 V	Off	Off	
10:M2	DC		100 V	Off	Off	

Use the CH SELECT key to change CH groups.
Start copying settings

<CH1 setting>

1. Move the cursor to the CH1 input and set it to "DC".

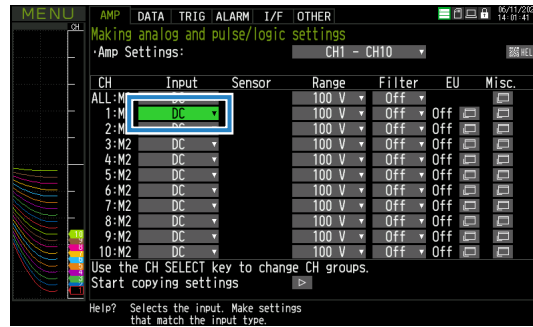

2. Move the cursor to the CH1 range and set it to "1V".

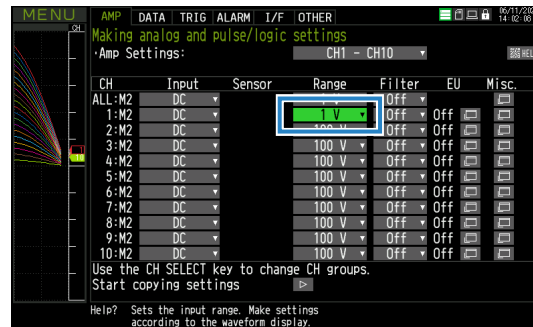

CH2 settings

1. Move the cursor to the CH2 input and set it to "TEMP".

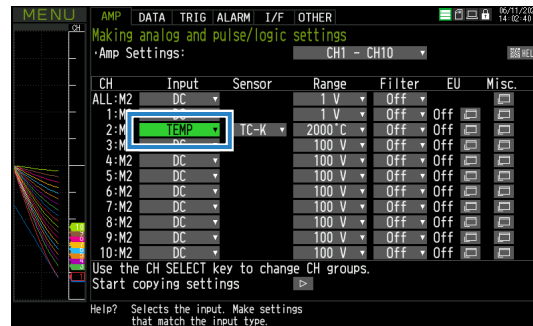

2. Move the cursor to the CH2 sensor and set it to "TC-T".

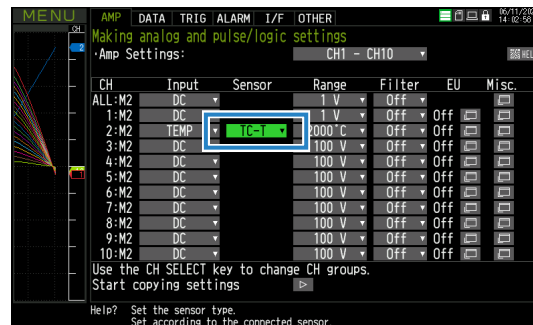

3. Move the cursor to the CH2 range and set it to "2000°C".

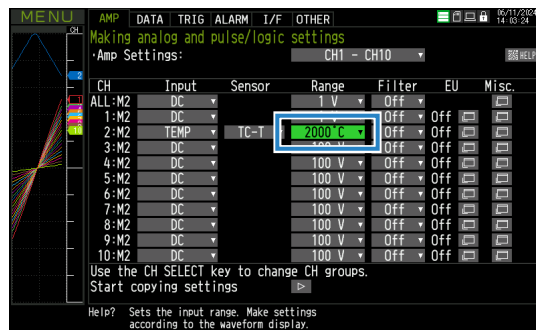

<Other CH settings>

Move the cursor to the other CH input and set it to "Off".

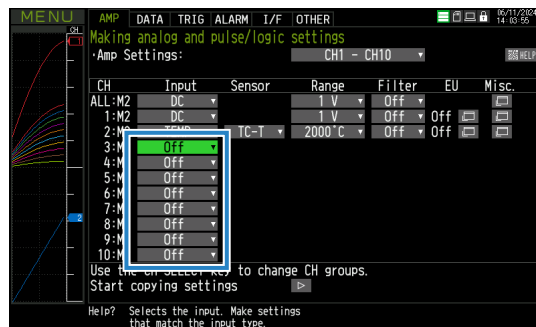

DATA setting

Press the "MENU" key to open the DATA setting screen.

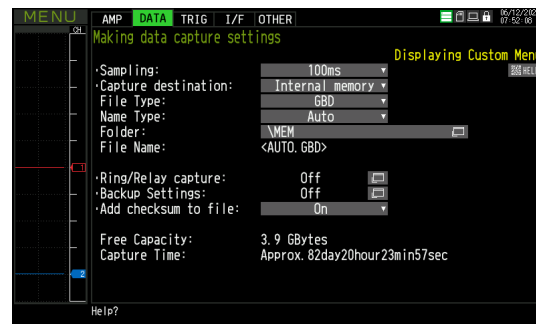
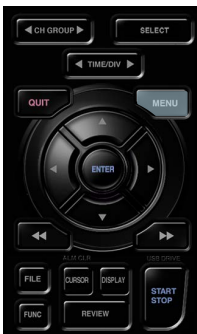

Sampling interval setting

Move the cursor to the sampling interval and set it to "1s".

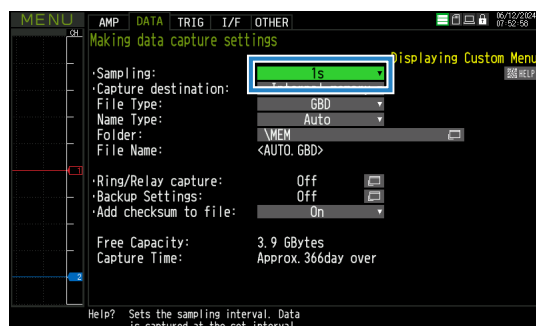

Data capturing destination setting

Set the data capturing destination media, file format, and file naming method.

1. Set the capturing destination to "Internal memory".

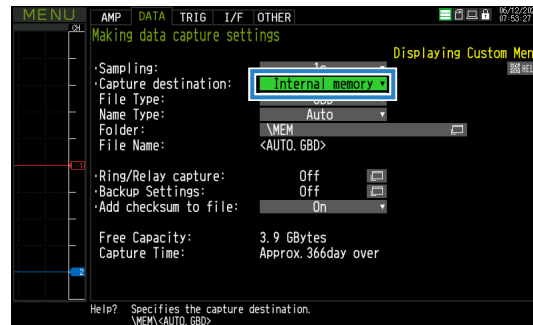

2. Set the file format to "GBD".

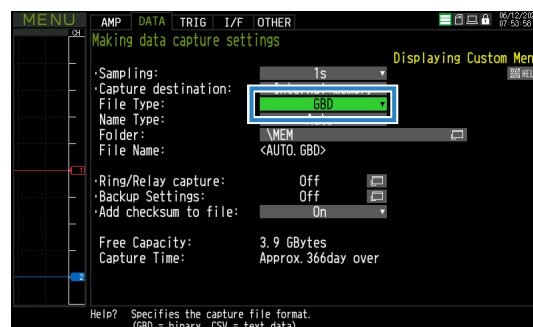

3. Set the naming method to "Auto".

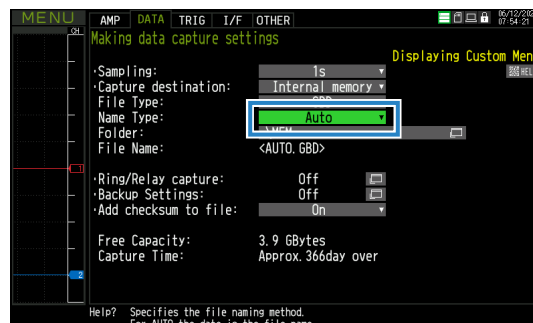
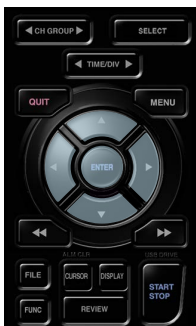

4. Set the capturing destination folder.

Move the cursor to the folder and press the "ENTER" key.

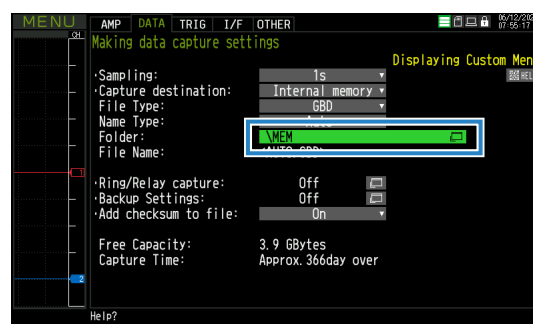

5. The Data saving destination specification dialog opens.

In the Data saving destination specification dialog, set the capturing destination of the internal memory (MEM).

* In the Data saving destination specification dialog, the folder name is enclosed in < >.

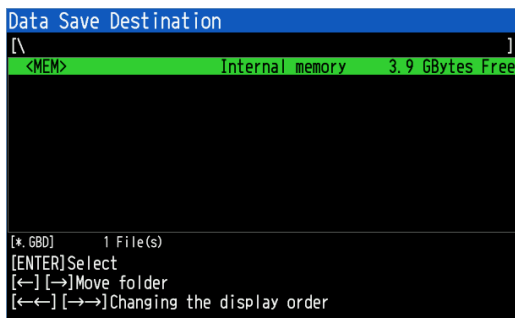

6. Press the ">" key to move into the <MEM> folder.

Move the cursor to "Create new folder" and press the "ENTER" key to display the new folder name input dialog.

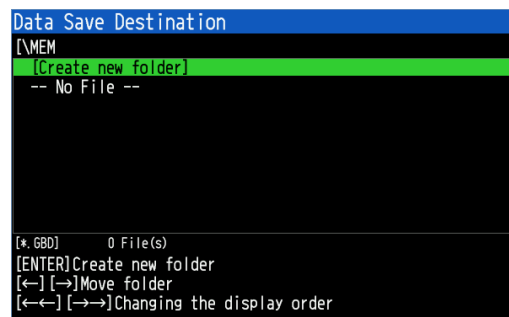

7. Create a "TEST" folder in the internal memory (MEM) and set it so that data is saved in the "\MEM\TEST" folder.

- Move the cursor to "A" in the character type selection using the "<>" keys.
- Since characters that can be entered are displayed in the character selection field, use the "Δ∇<>" keys to move the cursor to the character to be entered (in the order of "T", "E", "S" and "T") and press the "ENTER" key.
- Move the cursor to "OK" in the character type selection area and press the "ENTER" key to confirm.

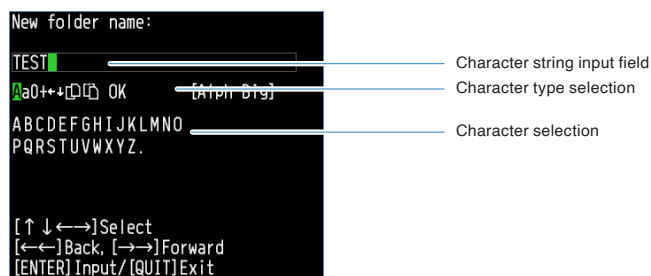

8. A "TEST" folder is created. Select the "TEST" folder and press the "ENTER" key.

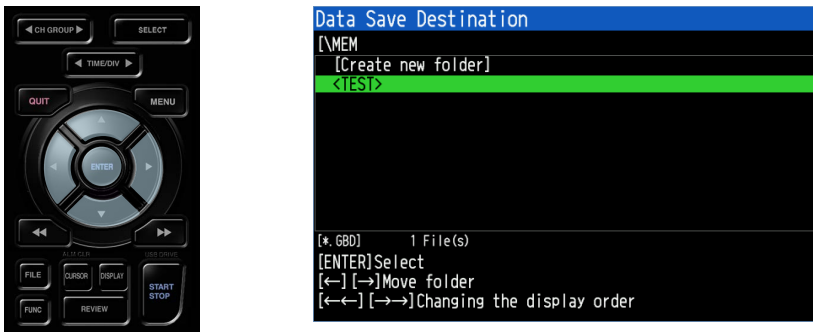

Data is captured in the <TEST> folder of the internal memory (MEM) with an automatic file name.



When using the automatic file name function, an additional <DATE> folder is created and the data is saved under it. You can check the available capturing capacity and capturing time at the bottom of the setting screen.

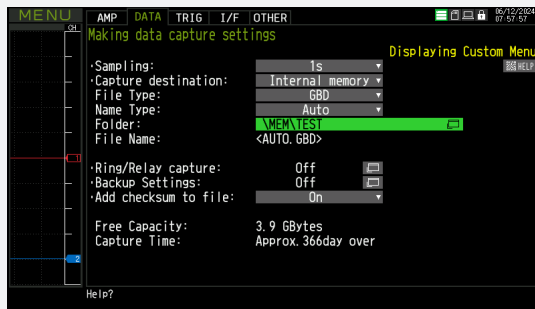

This completes the settings required for capturing.

3. Capturing

After the capturing settings are complete, start capturing.

Start capturing

1. Press the "START/STOP" key.

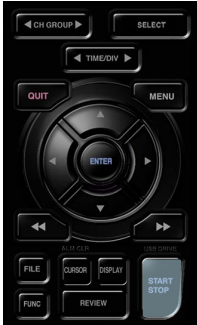

2. A confirmation message is displayed.

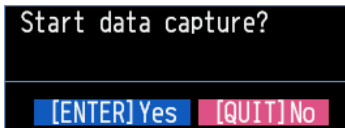

3. Press the "ENTER" key to start capturing.

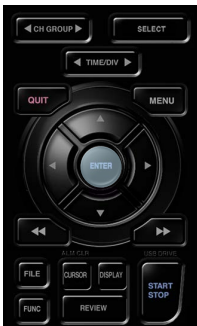

Capturing state

When capturing starts, the elapsed time and available capturing time are displayed.



Elapsed time

Available capturing time

Replaying during capture

When you press the "REVIEW" key during capturing, a replay can be performed during capture. While capturing data, you can replay the data from the beginning of the data to the point at which capturing was performed.

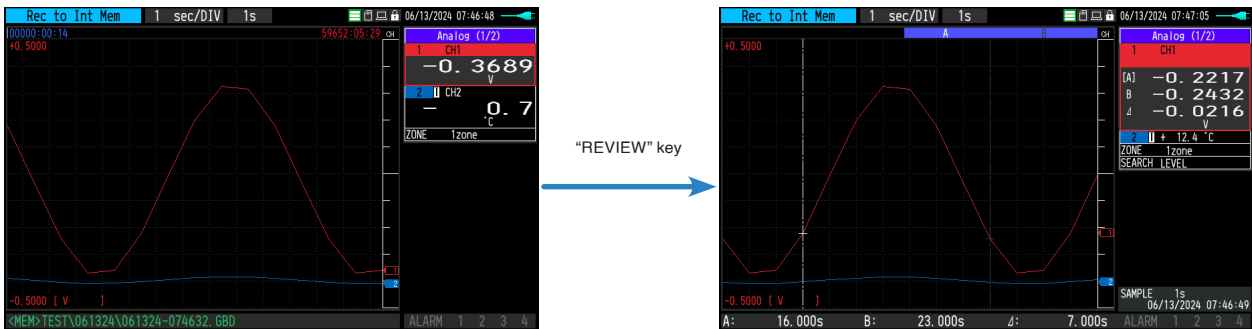

Checkpoint

During replay, you can move the cursor to check any data value. Press the "REVIEW" key again to return to the capturing screen.

Stop capturing

1. Press the "START/STOP" key.

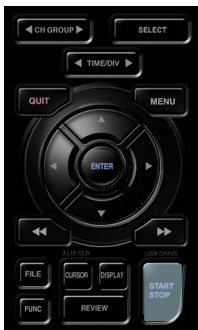

2. A confirmation message is displayed.

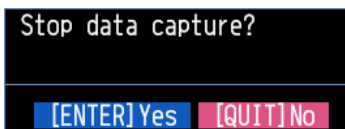

3. Press the "ENTER" key to finish capturing and enter the free-running state.

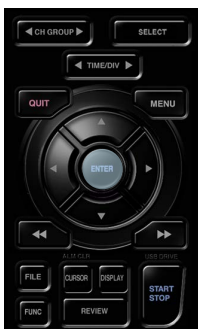

Data capturing is now complete.

4.2 Replay procedure

1. Replay procedure

We explain the simple procedure for replaying the captured data.

The captured data file uses the data captured in the "4.1 Capturing procedure".

The captured data files are stored in the "TEST\<date>" folder in the internal memory (MEM).

Since the captured data file name was saved with an automatic file name function, a file named "Month/Day/Year-Time.GBD" has been created. (The Month/Day/Year and Time are the time when capturing started.)

1. Press the "REVIEW" key.

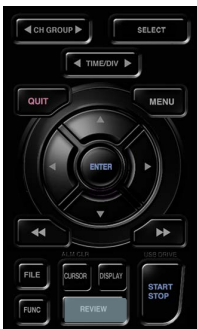

2. The data replay source specification dialog opens.

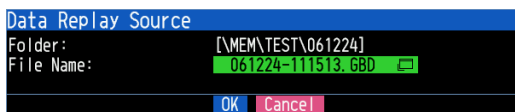

Checkpoint

The data file specified in the data replay source dialog is set to the data file captured immediately before. If you are performing this procedure immediately after performing "4.1 Capturing procedure", skip the "Specifying the data file to replay" below.

Specifying the data file to replay

1. In the data replay source specification dialog, move the cursor to the file and press the "ENTER" key.

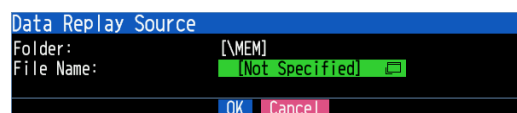
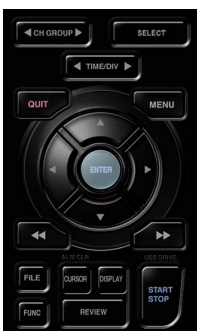

2. A file selection dialog is displayed.

```

Data Replay Source
[\
<MEM> Internal memory 3.9 GBytes Free

[*; GBD *.CSV] 1 File(s)
Cannot select
[←][→]Move folder
[←←][→→]Changing the display order

```

3. Use the "△▽◀▶" keys to move to the desired folder (\MEM\TEST\<date>), and use the "△▽" keys to select the desired file.

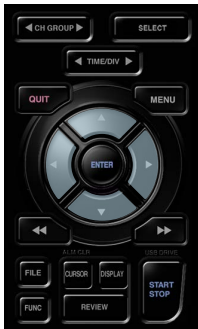

Use the "▶" key to move to the selected folder.

```

Data Replay Source
[\MEM
<TEST>

[*; GBD *.CSV] 1 File(s)
Cannot select
[←][→]Move folder
[←←][→→]Changing the display order

```

↓ "▶" key

```

Data Replay Source
[\MEM\TEST
<061224>

[*; GBD *.CSV] 2 File(s)
Cannot select
[←][→]Move folder
[←←][→→]Changing the display order

```

↓ "▶" key

```

Data Replay Source
[\MEM\TEST\061224
061224-111513.GBD 06/12/2024 11:15 8.2kB

[*; GBD *.CSV] 2 File(s)
[ENTER]Select
[←][→]Move folder
[←←][→→]Changing the display order を選択します。

```

Use the "△▽" keys to select the desired file.

4. Press the "ENTER" to confirm.

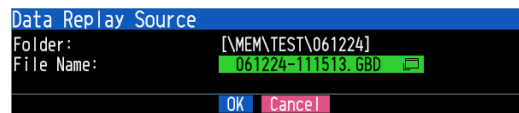
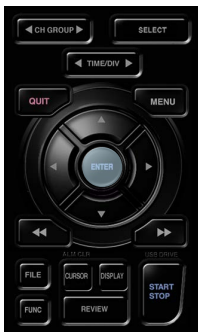

This completes the replay file settings.

Data replay

1. Move the cursor to "OK" using the " $\Delta \nabla < \triangleright$ " keys.

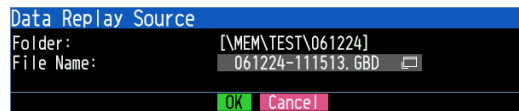

2. Press the "ENTER" key to play the data.

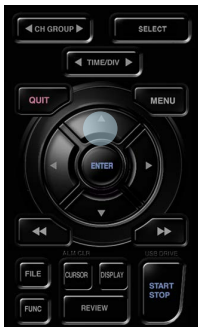

2. Replay screen

The data replay screen is described here.

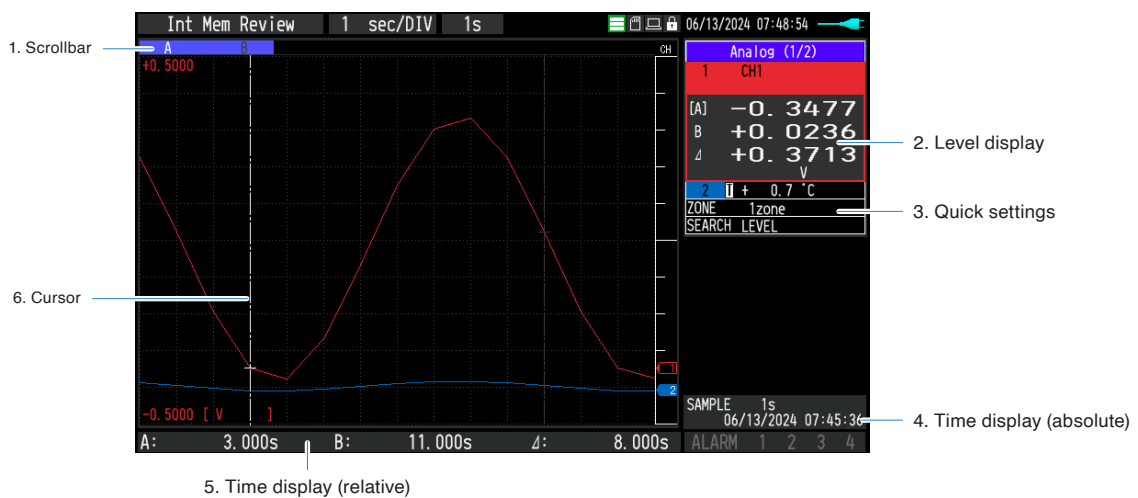

Name		Description
1. Scrollbar		The position and width of the entire waveform range are displayed on the screen. The position of the A/B cursors is also displayed.
2. Level display	Selected CH	The level value of the A/B cursors and cursor difference are displayed.
	Non-selected CH	The level value of the currently selected cursor is displayed.
3. Quick settings	ZONE	The waveform display can be switched between 1, 2, 5, and 10 divisions. 1 division: Displays all 10ch scales. 2 division: Divides the screen into 2 and displays 1, 3, 5, 7, 9ch and 2, 4, 6, 8, 10ch respectively. 5 division: Divides the screen into 5 and displays 1/6ch, 2/7ch, 3/8ch, 4/9ch and 5/10ch respectively. 10 division: Divides the screen into 10 and displays each channel individually.
	SEARCH	Use the "<" key to search the previous one, or use the ">" key to search the next one. Set the search settings in "3.4 Description of the setting menu", "(11) Data replay menu" and "(11)-6 Data search" in the Replay menu.
4. Time display (absolute)		The time at the position of the selection cursor is displayed. (Unit: 1 second)
5. Time display (relative)		The position of the selection cursor (relative time from the trigger point and differential time of the cursor) is displayed.
6. Cursor		The cursor is displayed. Cursor A/B selection can be switched by pressing the "CURSOR" key or "FUNC" key. The cursor is moved with the "<>" key or the "<<>>" key (high-speed movement). You can check any level value or time with the cursor.

3. Finish replaying

We describe how to finish the data replay using the data replay screen.

1. Press the "QUIT" key during replay.

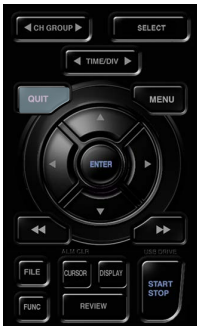

2. A confirmation message is displayed.

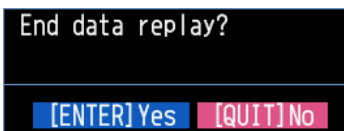

3. Press the "ENTER" key to finish replaying.

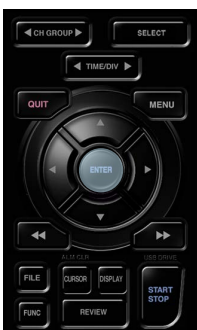

When the replay is finished, it will be in free running state.

4.3 Other functions

1. Custom function

The custom function is a function that hides the display of the function from the setting menu, etc. by setting the unused functions of the GL860 to OFF.

By hiding the display of functions that are not used, the settings can be streamlined and unnecessary setting errors can be prevented.

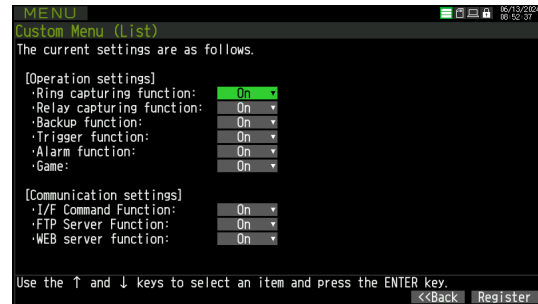
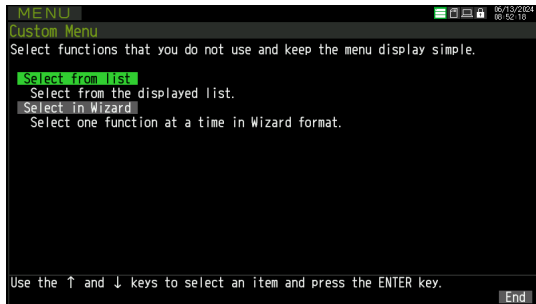

For details, please refer to "6-6 Custom menu" in "3.4 Setting menus".

2. Trigger function

The trigger function allows you to control the timing when data capturing starts and when data capturing stops. By using the trigger function, only the necessary data can be captured.

For example, you can set the following timings.

- Data capturing starts when the voltage of CH1 becomes 1V or more.
- Stop data capturing at 1:00 pm.
- Data capturing starts in synchronization with other devices. (External trigger input)

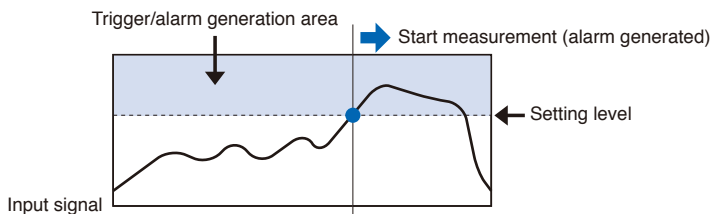

For details, refer to "3 TRIG setting" in "3.4 Setting menus".

3. Automatic span adjustment (auto span) function

The span can be automatically adjusted by selecting the "Automatic adjustment" in "AMP setting" – "Other settings" – "Span setting".

The range of the waveform currently displayed on the screen is subject to automatic adjustment.

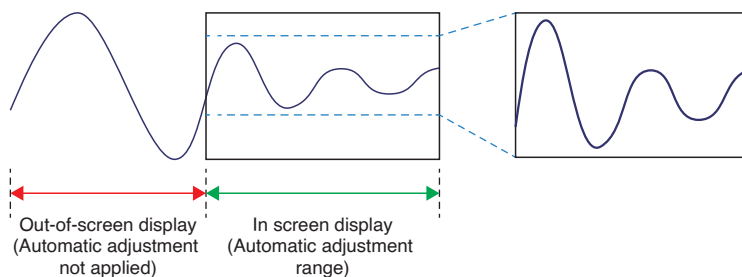

4. Remote control service cooperation function

The GL860 can be linked with the remote control service "G-REMOTE" operated by our company. Waveforms on GL devices can be checked and operated remotely. For details on G-REMOTE and how to apply, please visit our website (<http://www.graphteccorp.com/>).

Checkpoint

An optional wireless LAN module is required separately.
An environment that can connect to the network is required to use the service.

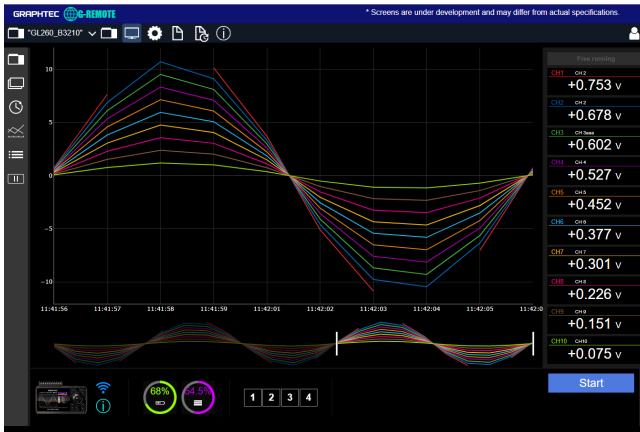

5. Data corruption check function

When data is captured in our original captured data format (GBD format), a checksum can be added to the data. By confirming this checksum, it is possible to confirm data corruption and prevent data tampering.

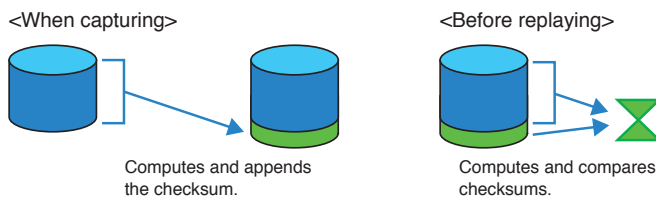

6. USB drive mode

When the GL860 and PC are connected via USB, the GL860 can be recognized by the PC as a USB mass storage. This function allows you to access the data of the internal memory and SD CARD of the GL860 from a PC via USB. By turning on the power while holding down the "START/STOP" key, it will be in USB drive mode.

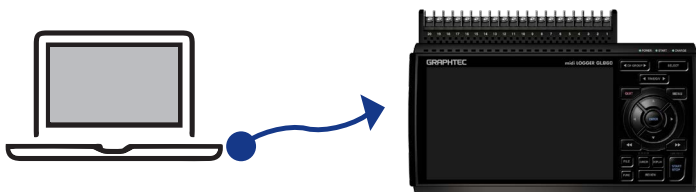

7. Inter-CH operation function

You can make the calculation result function as an independent CH and measure while comparing it with the original waveform before calculation.

Also, each calculation CH can be multiplied by a coefficient. You can add an offset at the end.

$$\text{CALC1} = (a \times \text{CHn} [+ - \times \div] b \times \text{CHn}) + c$$

a: Coefficient 1 b: Coefficient 2 c: Offset

8. Alarm history

A history of alarm events can be displayed.

Since you can check the history of alarm occurrences, you can check what kind of alarm occurred later.

You can also jump the cursor to the alarm event point during data replay.

```

Rec to Int Mem 06/13/2024 09:01:55
==== Alarm history ====
1: 06/13/2024 09:01:04 Clear CH1
2: 06/13/2024 09:01:10 Occur CH1
3: 06/13/2024 09:01:14 Clear CH1
4: 06/13/2024 09:01:20 Occur CH1
5: 06/13/2024 09:01:24 Clear CH1
6: 06/13/2024 09:01:30 Occur CH1
7: 06/13/2024 09:01:34 Clear CH1
8: 06/13/2024 09:01:40 Occur CH1
9: 06/13/2024 09:01:44 Clear CH1
10: 06/13/2024 09:01:50 Occur CH1
< Previous (1/1) Next (X) Filter settings
<< Top End >>

```

9. Memory loop function

When capturing data using the relay function, capturing stopped when the capturing disk became full. However, by using the memory loop function, the oldest relay file can be deleted and capturing can be continued when the capturing disk is full.

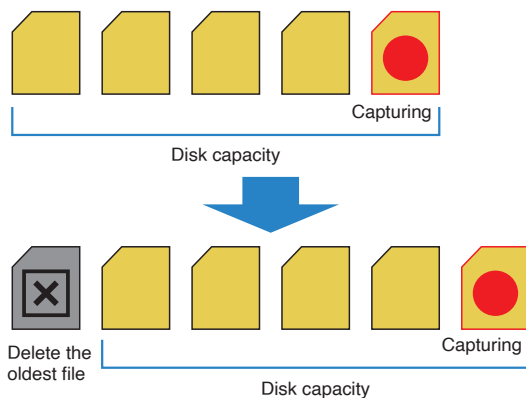

10. FUNC function

When you press the "FUNC" key, what you can do at that time is displayed in the lower right corner of the screen. If you have trouble with the operation, we recommend pressing the "FUNC" key.

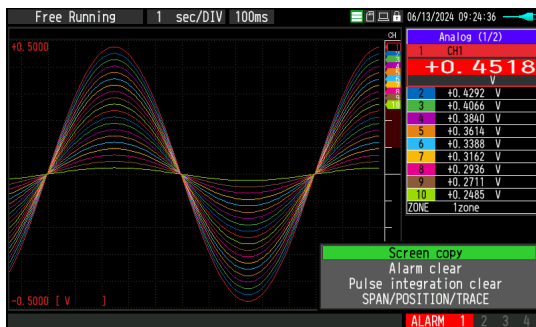

11. CH copy function

This function allows you to copy the settings of a specified CH to any other CH.

The settings that can be copied are as follows:

- AMP settings
- Calculation settings
- Trigger setting level values
- Alarm level values and output numbers

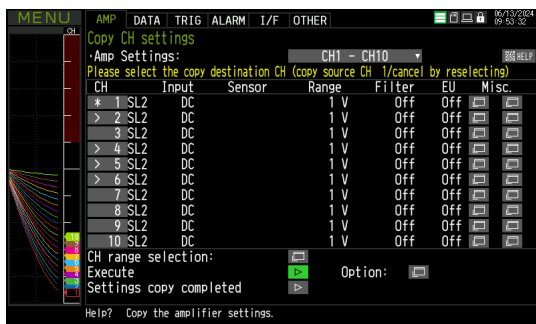

Chapter 5 Specification

This chapter describes the basic specifications for the GL860.

SECTION IN THIS CHAPTER

- 5.1 *Standard Specifications*
- 5.2 *Function Specifications*
- 5.3 *Accessories/Optional Accessories*
- 5.4 *External Dimensions*

5.1 Standard Specifications

Standard Specifications

Item		Description																																																					
Number of analog inputs		Maximum 200ch available for 1 terminal(20ch/30ch) or extension unit																																																					
Analog terminal unit type		<ul style="list-style-type: none"> Standard 20CH screw terminal Standard 20CH screwless terminal Standard 30CH screwless terminal Withstand high-voltage high-precision terminal 																																																					
Data backup functions		Setup parameters: EEPROM/Clock: Lithium battery																																																					
Clock accuracy (23°C environment)		±0.002% (accurate within about 50 seconds per month)																																																					
Operating environment		0 to 45°C, 5 to 85% RH (0 to 40°C when operated in batteries/15 to 35°C when a battery is charging)																																																					
Withstand voltage	Standard terminal	Between each input ch and GND terminal: 350Vp-p 1 minute Between each input terminal: 350Vp-p 1 minute																																																					
	Withstand high-voltage high-precision terminal	Between each input ch and GND terminal: 2300VACrms 1 minute Between each input terminal: 600Vp-p																																																					
Power supply		<ul style="list-style-type: none"> AC adapter: 100 to 240 VAC, 50 to 60 Hz DC input: 8.5 to 24 VDC (26.4 V max.) Battery pack (option): 7.2 VDC (2875 mAh), two packs can be mounted 																																																					
Power consumption		<p>AC power consumption (when using the AC adapter provided as a standard accessory)</p> <table border="1"> <thead> <tr> <th>No.</th> <th>Condition</th> <th>Power supply</th> <th>Normal</th> <th>During recharging battery</th> </tr> </thead> <tbody> <tr> <td rowspan="2">1</td> <td rowspan="2">When the LCD is on</td> <td>AC100V</td> <td>24VA</td> <td>38VA</td> </tr> <tr> <td>AC240V</td> <td>35VA</td> <td>55VA</td> </tr> <tr> <td rowspan="2">2</td> <td rowspan="2">When the screen saver is operating</td> <td>AC100V</td> <td>19VA</td> <td>33VA</td> </tr> <tr> <td>AC240V</td> <td>27VA</td> <td>49VA</td> </tr> </tbody> </table> <p>DC current consumption</p> <table border="1"> <thead> <tr> <th>No.</th> <th>DC voltage</th> <th>Condition</th> <th>Normal</th> <th>During recharging battery</th> </tr> </thead> <tbody> <tr> <td>1</td> <td rowspan="2">+24V</td> <td>When the LCD is on</td> <td>0.36A</td> <td>0.65A</td> </tr> <tr> <td>2</td> <td>When the screen saver is operating</td> <td>0.27A</td> <td>0.56A</td> </tr> <tr> <td>3</td> <td rowspan="2">+12V</td> <td>When the LCD is on</td> <td>0.70A</td> <td>Recharging not possible</td> </tr> <tr> <td>4</td> <td>When the screen saver is operating</td> <td>0.50A</td> <td>Recharging not possible</td> </tr> <tr> <td>5</td> <td rowspan="2">+8.5V</td> <td>When the LCD is on</td> <td>1.00A</td> <td>Recharging not possible</td> </tr> <tr> <td>6</td> <td>When the screen saver is operating</td> <td>0.70A</td> <td>Recharging not possible</td> </tr> </tbody> </table> <p>* Normal condition: LCD brightness is set to MAX.</p>	No.	Condition	Power supply	Normal	During recharging battery	1	When the LCD is on	AC100V	24VA	38VA	AC240V	35VA	55VA	2	When the screen saver is operating	AC100V	19VA	33VA	AC240V	27VA	49VA	No.	DC voltage	Condition	Normal	During recharging battery	1	+24V	When the LCD is on	0.36A	0.65A	2	When the screen saver is operating	0.27A	0.56A	3	+12V	When the LCD is on	0.70A	Recharging not possible	4	When the screen saver is operating	0.50A	Recharging not possible	5	+8.5V	When the LCD is on	1.00A	Recharging not possible	6	When the screen saver is operating	0.70A	Recharging not possible
No.	Condition	Power supply	Normal	During recharging battery																																																			
1	When the LCD is on	AC100V	24VA	38VA																																																			
		AC240V	35VA	55VA																																																			
2	When the screen saver is operating	AC100V	19VA	33VA																																																			
		AC240V	27VA	49VA																																																			
No.	DC voltage	Condition	Normal	During recharging battery																																																			
1	+24V	When the LCD is on	0.36A	0.65A																																																			
2		When the screen saver is operating	0.27A	0.56A																																																			
3	+12V	When the LCD is on	0.70A	Recharging not possible																																																			
4		When the screen saver is operating	0.50A	Recharging not possible																																																			
5	+8.5V	When the LCD is on	1.00A	Recharging not possible																																																			
6		When the screen saver is operating	0.70A	Recharging not possible																																																			
External dimensions (approximate) [W × D × H]	Standard terminal	240 × 158 × 52.5mm (not including protruding parts)																																																					
	Withstand high-voltage high-precision terminal	240 × 166 × 52.5mm (not including protruding parts)																																																					
	Standard screwless terminal	240 × 158 × 52.5mm (not including protruding parts)																																																					

Item		Description
Weight (approximate) *1	Standard terminal	1010g
	Withstand high-voltage high-precision terminal	1035g
	Standard screwless terminal	1010g
Vibration- tested conditions		Equivalent to Automobile parts Type 1 Class A Buzzer (key, etc.)

*1: AC adapter and battery are not included., but one terminal unit is included.

Memory devices

Item	Description
Memory capacity	Internal memory: approx. 8GB *1 SD CARD slot: 1 *1 *2
Memory contents	<ul style="list-style-type: none"> • Setup conditions • Measured data • Screen copy

*1 Possible to save up to 2GByte for one file

*2 SDHC compatible, maximum approx, 32GByte memory is available,Compatible with FAT / FAT32 format only.

PC I/F

Item	Description
Interface types	Ethernet (10BASE-T/100BASE-TX) USB 2.0 Wireless LAN (Option)
Functions	Data transfer to the PC (real-time, Internal memory or SD CARD data) PC control of the GL860
Ethernet functions (10BASE-T/100BASE-TX)	<p>Web server functions: Displays the screen image of the GL860 with a browser, and operates the GL860.</p> <p>FTP server function: Transfer and delete the captured data in the internal memory or SD CARD.</p> <p>FTP client function: Back up the captured data to the FTP server.</p> <p>NTP client function: Time-synchronize the NTP server.</p> <p>DHCP client function: IP address automatic acquisition.</p> <p>DHCP server function : IP address automatic distribution. (Wireless LAN/In access point mode only)</p> <p>E-mail function: Send and receive the e-mail</p> <p>Modbus TCP communication: Communication with sequencers via Modbus TCP.</p> <p>Link function with G-REMOTE: Linkage with Graphtec's G-REMOTE service.</p>
USB functions	USB drive mode: Transfer and delete the captured data in the internal memory or SD memory card.
Realtime data transfer speed *1	5 ms/1 ch maximum

*1: The transfer speed depends on the number of channels.

Monitor

Item	Description
Display	7-inch TFT color LCD (WVGA: 800 × 480 dots)
Displayed languages	Japanese, English, French, German, Chinese, Korean, Russian, Spanish
Backlight life	50,000 hrs (until the brightness is reduced to 50%), It varies with the operating environment.
Backlight	Screen saver function provided (10, 30 sec., 1, 2, 5, 10, 30, 60 min.)

B-563/B-563SL Specifications

Item		Description
Number of input channels	Standard 20CH screw terminal	20 channels (Up to 200 channels when using with the expansion terminal base) * Between GL860 and terminal and between terminals can be directly connected or with an expansion terminal connection cable (sold separately)
	Standard 20CH screwless terminal	20 channels (Up to 200 channels when using with the expansion terminal base) * Between GL860 and terminal and between terminals can be directly connected or with an expansion terminal connection cable (sold separately)
Input terminal type	Standard 20CH screw terminal	M3 screw-type terminals (Rectangular flat washer)
	Standard 20CH screwless terminal	Screwless terminal
Input method	Photo MOS relay scanning system All channels isolated, balanced input	
Scan speed	5 ms/1 ch maximum	
Measurement ranges	Voltage: 20, 50, 100, 200, 500 mV, 1, 2, 5, 10, 20, 50, 100 V, 1-5 V F.S.	
	Temperature Thermocouples: K, J, E, T, R, S, B, N, C (W: WRe5-26) Temperature range: 100°C, 500°C, 2000°C (In the case of Fahrenheit: 150°F, 750°F, 3000°F)	
	Humidity: 0 to 100% (voltage 0 to 1 V scaling conversion) fixed	
Measurement accuracy (23°C ±5°C) • When 30 minutes or more have elapsed after power was switched on • Sampling 1 s/10 ch • Filter ON (10) • GND connected	Voltage: 0.1% of F.S. Temperature • Thermocouple	
	Thermocouple	Measurement Temperature Range (°C)
	R/S	0 ≤ TS ≤ 100°C 100 < TS ≤ 300°C R : 300 < TS ≤ 1600°C S : 300 < TS ≤ 1760°C
	B	400 ≤ TS ≤ 600°C 600 < TS ≤ 1820°C
	K	-200 ≤ TS ≤ -100°C -100 < TS ≤ 1370°C
	E	-200 ≤ TS ≤ -100°C -100 < TS ≤ 800°C
	T	-200 ≤ TS ≤ -100°C -100 < TS ≤ 400°C
	J	-200 ≤ TS ≤ -100°C -100 < TS ≤ 100°C 100 < TS ≤ 1100°C
	N	-200 ≤ TS < 0°C 0 ≤ TS ≤ 1300°C
	C (W)	0 ≤ TS ≤ 2000°C
Reference contact compensation accuracy		±0.5°C

* Thermocouple diameters T, K: 0.32 φ, others: 0.65 φ

Item	Description																																											
	<p>• Temperature range</p> <table border="1"> <thead> <tr> <th>Type</th> <th>Temperature range</th> <th>Resolution</th> <th>Measurement Range</th> </tr> </thead> <tbody> <tr> <td rowspan="3">R/S</td> <td>100°C F.S.</td> <td>0.01°C</td> <td>0 to 100°C</td> </tr> <tr> <td>500°C F.S.</td> <td>0.05°C</td> <td>0 to 500°C</td> </tr> <tr> <td>2000°C F.S.</td> <td>0.1°C</td> <td>R: 0 to 1600°C S: 0 to 1760°C</td> </tr> <tr> <td rowspan="2">B</td> <td>500°C F.S.</td> <td>0.05°C</td> <td>400 to 500°C</td> </tr> <tr> <td>2000°C F.S.</td> <td>0.01°C</td> <td>500 to 1820°C</td> </tr> <tr> <td rowspan="4">K/E/T/J/N</td> <td>100°C F.S.</td> <td>0.01°C</td> <td>-100 to 100°C</td> </tr> <tr> <td>500°C F.S.</td> <td>0.05°C</td> <td>K/E/J/N : -200 to 500°C T: -200 to 400°C</td> </tr> <tr> <td rowspan="3">2000°C F.S.</td> <td rowspan="3">0.1°C</td> <td>K: -200 to 1370°C</td> </tr> <tr> <td>E: -200 to 800°C</td> </tr> <tr> <td>T: -200 to 400°C</td> </tr> <tr> <td rowspan="3">C (W)</td> <td>100°C F.S.</td> <td>0.01°C</td> <td>0 to 100°C</td> </tr> <tr> <td>500°C F.S.</td> <td>0.05°C</td> <td>0 to 500°C</td> </tr> <tr> <td>2000°C F.S.</td> <td>0.1°C</td> <td>0 to 2000°C</td> </tr> </tbody> </table> <p>* Measurement accuracy does not change due to the temperature range.</p>	Type	Temperature range	Resolution	Measurement Range	R/S	100°C F.S.	0.01°C	0 to 100°C	500°C F.S.	0.05°C	0 to 500°C	2000°C F.S.	0.1°C	R: 0 to 1600°C S: 0 to 1760°C	B	500°C F.S.	0.05°C	400 to 500°C	2000°C F.S.	0.01°C	500 to 1820°C	K/E/T/J/N	100°C F.S.	0.01°C	-100 to 100°C	500°C F.S.	0.05°C	K/E/J/N : -200 to 500°C T: -200 to 400°C	2000°C F.S.	0.1°C	K: -200 to 1370°C	E: -200 to 800°C	T: -200 to 400°C	C (W)	100°C F.S.	0.01°C	0 to 100°C	500°C F.S.	0.05°C	0 to 500°C	2000°C F.S.	0.1°C	0 to 2000°C
Type	Temperature range	Resolution	Measurement Range																																									
R/S	100°C F.S.	0.01°C	0 to 100°C																																									
	500°C F.S.	0.05°C	0 to 500°C																																									
	2000°C F.S.	0.1°C	R: 0 to 1600°C S: 0 to 1760°C																																									
B	500°C F.S.	0.05°C	400 to 500°C																																									
	2000°C F.S.	0.01°C	500 to 1820°C																																									
K/E/T/J/N	100°C F.S.	0.01°C	-100 to 100°C																																									
	500°C F.S.	0.05°C	K/E/J/N : -200 to 500°C T: -200 to 400°C																																									
	2000°C F.S.	0.1°C	K: -200 to 1370°C																																									
			E: -200 to 800°C																																									
T: -200 to 400°C																																												
C (W)	100°C F.S.	0.01°C	0 to 100°C																																									
	500°C F.S.	0.05°C	0 to 500°C																																									
	2000°C F.S.	0.1°C	0 to 2000°C																																									
Reference contact compensation accuracy	Internal/External switching																																											
A/D converter	Method: $\Delta\Sigma$ method Resolution: 16-bit (Effective resolution: About 1/40000 of the +/- range)																																											
Temperature coefficient	Gain: 0.01% of F.S./°C Zero: 0.02% of F.S./°C * Zero occurs at the sampling of 5, 10, 20, and 50 ms.																																											
Input resistance	1M Ω \pm 5%																																											
Allowable signal source resistance	Within 300 Ω																																											
Maximum permissible input voltage	Between +/- terminals: 20mV to 2V range (60Vp-p) 5V to 100V range (110Vp-p) Between input terminal/input terminal: 60 Vp-p Between input terminal/GND: 60 Vp-p																																											
Withstand voltage	Between input terminal/input terminal: 350 Vp-p 1 minute Between input terminal/GND: 350 Vp-p 1 minute																																											
Insulation resistance	Between input terminal/GND: 50M Ω or more (at 500 VDC)																																											
Common mode rejection ratio	90 dB or more (50/60 Hz; signal source 300 Ω or less)																																											
Noise	48 dB or more (with +/- terminals shorted)																																											
Filter	Off, 2, 5, 10, 20, 40 Filter operation is on a moving average basis. The average value of the number of set samples is used. If the sample interval exceeds 30 seconds, the average value of data obtained in a sub-sample (30 seconds) is used.																																											

B-563SL-30 Specifications

Item	Description																																																		
Number of input channels	30 channels (Up to 200 channels when using with the expansion terminal base) * Between GL860 and terminal and between terminals can be directly connected or with an expansion terminal connection cable (sold separately)																																																		
Input terminal type	Screwless terminal																																																		
Input method	Photo MOS relay scanning system All channels isolated, balanced input																																																		
Scan speed	5 ms/1 ch maximum																																																		
Measurement ranges	Voltage: 20, 50, 100, 200, 500 mV, 1, 2, 5, 10, 20, 50, 100 V, 1-5 V F.S.																																																		
	Temperature Thermocouples: K, J, E, T, R, S, B, N, C (W: WRe5-26) Temperature range: 100°C, 500°C, 2000°C (In the case of Fahrenheit: 150°F, 750°F, 3000°F)																																																		
	Humidity: 0 to 100% (voltage 0 to 1 V scaling conversion) fixed																																																		
Measurement accuracy (23°C ±5°C) • When 30 minutes or more have elapsed after power was switched on • Sampling 2 s/30 ch • Filter ON (10) • GND connected	Voltage: 0.1% of F.S. Temperature • Thermocouple																																																		
	<table border="1"> <thead> <tr> <th>Thermocouple</th> <th>Measurement Temperature Range (°C)</th> <th>Measurement Accuracy</th> </tr> </thead> <tbody> <tr> <td rowspan="4">R/S</td> <td>0 ≤ TS ≤ 100°C</td> <td>±5.2°C</td> </tr> <tr> <td>100 < TS ≤ 300°C</td> <td>±3.0°C</td> </tr> <tr> <td>R : 300 < TS ≤ 1600°C</td> <td>± (0.05% of rdg +2.0°C)</td> </tr> <tr> <td>S : 300 < TS ≤ 1760°C</td> <td>± (0.05% of rdg +2.0°C)</td> </tr> <tr> <td rowspan="2">B</td> <td>400 ≤ TS ≤ 600°C</td> <td>±3.5°C</td> </tr> <tr> <td>600 < TS ≤ 1820°C</td> <td>± (0.05% of rdg +2.0°C)</td> </tr> <tr> <td rowspan="2">K</td> <td>-200 ≤ TS ≤ -100°C</td> <td>± (0.05% of rdg +2.0°C)</td> </tr> <tr> <td>-100 < TS ≤ 1370°C</td> <td>± (0.05% of rdg +1.0°C)</td> </tr> <tr> <td rowspan="2">E</td> <td>-200 ≤ TS ≤ -100°C</td> <td>± (0.05% of rdg +2.0°C)</td> </tr> <tr> <td>-100 < TS ≤ 800°C</td> <td>± (0.05% of rdg +1.0°C)</td> </tr> <tr> <td rowspan="2">T</td> <td>-200 ≤ TS ≤ -100°C</td> <td>± (0.1% of rdg +1.5°C)</td> </tr> <tr> <td>-100 < TS ≤ 400°C</td> <td>± (0.1% of rdg +0.5°C)</td> </tr> <tr> <td rowspan="3">J</td> <td>-200 ≤ TS ≤ -100°C</td> <td>±2.7°C</td> </tr> <tr> <td>-100 < TS ≤ 100°C</td> <td>±1.7°C</td> </tr> <tr> <td>100 < TS ≤ 1100°C</td> <td>± (0.05% of rdg +1.0°C)</td> </tr> <tr> <td rowspan="2">N</td> <td>-200 ≤ TS < 0°C</td> <td>± (0.1% of rdg +2.0°C)</td> </tr> <tr> <td>0 ≤ TS ≤ 1300°C</td> <td>± (0.1% of rdg +1.0°C)</td> </tr> <tr> <td>C (W)</td> <td>0 ≤ TS ≤ 2000°C</td> <td>± (0.1% of rdg +1.5°C)</td> </tr> <tr> <td colspan="2">Reference contact compensation accuracy</td> <td>±0.5°C</td> </tr> </tbody> </table>	Thermocouple	Measurement Temperature Range (°C)	Measurement Accuracy	R/S	0 ≤ TS ≤ 100°C	±5.2°C	100 < TS ≤ 300°C	±3.0°C	R : 300 < TS ≤ 1600°C	± (0.05% of rdg +2.0°C)	S : 300 < TS ≤ 1760°C	± (0.05% of rdg +2.0°C)	B	400 ≤ TS ≤ 600°C	±3.5°C	600 < TS ≤ 1820°C	± (0.05% of rdg +2.0°C)	K	-200 ≤ TS ≤ -100°C	± (0.05% of rdg +2.0°C)	-100 < TS ≤ 1370°C	± (0.05% of rdg +1.0°C)	E	-200 ≤ TS ≤ -100°C	± (0.05% of rdg +2.0°C)	-100 < TS ≤ 800°C	± (0.05% of rdg +1.0°C)	T	-200 ≤ TS ≤ -100°C	± (0.1% of rdg +1.5°C)	-100 < TS ≤ 400°C	± (0.1% of rdg +0.5°C)	J	-200 ≤ TS ≤ -100°C	±2.7°C	-100 < TS ≤ 100°C	±1.7°C	100 < TS ≤ 1100°C	± (0.05% of rdg +1.0°C)	N	-200 ≤ TS < 0°C	± (0.1% of rdg +2.0°C)	0 ≤ TS ≤ 1300°C	± (0.1% of rdg +1.0°C)	C (W)	0 ≤ TS ≤ 2000°C	± (0.1% of rdg +1.5°C)	Reference contact compensation accuracy		±0.5°C
	Thermocouple	Measurement Temperature Range (°C)	Measurement Accuracy																																																
	R/S	0 ≤ TS ≤ 100°C	±5.2°C																																																
		100 < TS ≤ 300°C	±3.0°C																																																
		R : 300 < TS ≤ 1600°C	± (0.05% of rdg +2.0°C)																																																
		S : 300 < TS ≤ 1760°C	± (0.05% of rdg +2.0°C)																																																
	B	400 ≤ TS ≤ 600°C	±3.5°C																																																
		600 < TS ≤ 1820°C	± (0.05% of rdg +2.0°C)																																																
	K	-200 ≤ TS ≤ -100°C	± (0.05% of rdg +2.0°C)																																																
-100 < TS ≤ 1370°C		± (0.05% of rdg +1.0°C)																																																	
E	-200 ≤ TS ≤ -100°C	± (0.05% of rdg +2.0°C)																																																	
	-100 < TS ≤ 800°C	± (0.05% of rdg +1.0°C)																																																	
T	-200 ≤ TS ≤ -100°C	± (0.1% of rdg +1.5°C)																																																	
	-100 < TS ≤ 400°C	± (0.1% of rdg +0.5°C)																																																	
J	-200 ≤ TS ≤ -100°C	±2.7°C																																																	
	-100 < TS ≤ 100°C	±1.7°C																																																	
	100 < TS ≤ 1100°C	± (0.05% of rdg +1.0°C)																																																	
N	-200 ≤ TS < 0°C	± (0.1% of rdg +2.0°C)																																																	
	0 ≤ TS ≤ 1300°C	± (0.1% of rdg +1.0°C)																																																	
C (W)	0 ≤ TS ≤ 2000°C	± (0.1% of rdg +1.5°C)																																																	
Reference contact compensation accuracy		±0.5°C																																																	
* Thermocouple diameters T, K: 0.32 φ, others: 0.65 φ																																																			

Item	Description																																									
	<p>• Temperature range</p> <table border="1" data-bbox="544 264 1430 880"> <thead> <tr> <th data-bbox="544 264 708 322">Type</th> <th data-bbox="708 264 922 322">Temperature range</th> <th data-bbox="922 264 1129 322">Resolution</th> <th data-bbox="1129 264 1430 322">Measurement Range</th> </tr> </thead> <tbody> <tr> <td data-bbox="544 322 708 456" rowspan="3">R/S</td> <td data-bbox="708 322 922 358">100°C F.S.</td> <td data-bbox="922 322 1129 358">0.01°C</td> <td data-bbox="1129 322 1430 358">0 to 100°C</td> </tr> <tr> <td data-bbox="708 358 922 394">500°C F.S.</td> <td data-bbox="922 358 1129 394">0.05°C</td> <td data-bbox="1129 358 1430 394">0 to 500°C</td> </tr> <tr> <td data-bbox="708 394 922 456">2000°C F.S.</td> <td data-bbox="922 394 1129 456">0.1°C</td> <td data-bbox="1129 394 1430 456">R : 0 to 1600°C S : 0 to 1760°C</td> </tr> <tr> <td data-bbox="544 456 708 524" rowspan="2">B</td> <td data-bbox="708 456 922 492">500°C F.S.</td> <td data-bbox="922 456 1129 492">0.05°C</td> <td data-bbox="1129 456 1430 492">400 to 500°C</td> </tr> <tr> <td data-bbox="708 492 922 524">2000°C F.S.</td> <td data-bbox="922 492 1129 524">0.01°C</td> <td data-bbox="1129 492 1430 524">500 to 1820°C</td> </tr> <tr> <td data-bbox="544 524 708 779" rowspan="3">K/E/T/J/N</td> <td data-bbox="708 524 922 560">100°C F.S.</td> <td data-bbox="922 524 1129 560">0.01°C</td> <td data-bbox="1129 524 1430 560">-100 to 100°C</td> </tr> <tr> <td data-bbox="708 560 922 618">500°C F.S.</td> <td data-bbox="922 560 1129 618">0.05°C</td> <td data-bbox="1129 560 1430 618">K/E/J/N: -200 to 500°C T: -200 to 400°C</td> </tr> <tr> <td data-bbox="708 618 922 779">2000°C F.S.</td> <td data-bbox="922 618 1129 779">0.1°C</td> <td data-bbox="1129 618 1430 779">K: -200 to 1370°C E: -200 to 800°C T: -200 to 400°C J: -200 to 1100°C N: -200 to 2000°C</td> </tr> <tr> <td data-bbox="544 779 708 880" rowspan="3">C (W)</td> <td data-bbox="708 779 922 815">100°C F.S.</td> <td data-bbox="922 779 1129 815">0.01°C</td> <td data-bbox="1129 779 1430 815">0 to 100°C</td> </tr> <tr> <td data-bbox="708 815 922 851">500°C F.S.</td> <td data-bbox="922 815 1129 851">0.05°C</td> <td data-bbox="1129 815 1430 851">0 to 500°C</td> </tr> <tr> <td data-bbox="708 851 922 880">2000°C F.S.</td> <td data-bbox="922 851 1129 880">0.1°C</td> <td data-bbox="1129 851 1430 880">0 to 2000°C</td> </tr> </tbody> </table> <p>* Measurement accuracy does not change due to the temperature range.</p>	Type	Temperature range	Resolution	Measurement Range	R/S	100°C F.S.	0.01°C	0 to 100°C	500°C F.S.	0.05°C	0 to 500°C	2000°C F.S.	0.1°C	R : 0 to 1600°C S : 0 to 1760°C	B	500°C F.S.	0.05°C	400 to 500°C	2000°C F.S.	0.01°C	500 to 1820°C	K/E/T/J/N	100°C F.S.	0.01°C	-100 to 100°C	500°C F.S.	0.05°C	K/E/J/N: -200 to 500°C T: -200 to 400°C	2000°C F.S.	0.1°C	K: -200 to 1370°C E: -200 to 800°C T: -200 to 400°C J: -200 to 1100°C N: -200 to 2000°C	C (W)	100°C F.S.	0.01°C	0 to 100°C	500°C F.S.	0.05°C	0 to 500°C	2000°C F.S.	0.1°C	0 to 2000°C
Type	Temperature range	Resolution	Measurement Range																																							
R/S	100°C F.S.	0.01°C	0 to 100°C																																							
	500°C F.S.	0.05°C	0 to 500°C																																							
	2000°C F.S.	0.1°C	R : 0 to 1600°C S : 0 to 1760°C																																							
B	500°C F.S.	0.05°C	400 to 500°C																																							
	2000°C F.S.	0.01°C	500 to 1820°C																																							
K/E/T/J/N	100°C F.S.	0.01°C	-100 to 100°C																																							
	500°C F.S.	0.05°C	K/E/J/N: -200 to 500°C T: -200 to 400°C																																							
	2000°C F.S.	0.1°C	K: -200 to 1370°C E: -200 to 800°C T: -200 to 400°C J: -200 to 1100°C N: -200 to 2000°C																																							
C (W)	100°C F.S.	0.01°C	0 to 100°C																																							
	500°C F.S.	0.05°C	0 to 500°C																																							
	2000°C F.S.	0.1°C	0 to 2000°C																																							
Reference contact compensation accuracy	Internal/External switching																																									
A/D converter	Method: $\Delta\Sigma$ method Resolution: 16-bit (Effective resolution: About 1/40000 of the +/- range)																																									
Temperature coefficient	Gain: 0.01% of F.S./°C Zero: 0.02% of F.S./°C * Zero occurs at the sampling of 5, 10, 20, and 50 ms.																																									
Input resistance	1M Ω \pm 5%																																									
Allowable signal source resistance	Within 300 Ω																																									
Maximum permissible input voltage	Between +/- terminals: 20mV to 2V range (60Vp-p) 5V to 100V range (110Vp-p) Between input terminal/input terminal: 60 Vp-p Between input terminal/GND: 60 Vp-p																																									
Withstand voltage	Between input terminal/input terminal: 350 Vp-p 1 minute Between input terminal/GND: 350 Vp-p 1 minute																																									
Insulation resistance	Between input terminal/GND: 50M Ω or more (at 500 VDC)																																									
Common mode rejection ratio	90 dB or more (50/60 Hz; signal source 300 Ω or less)																																									
Noise	48 dB or more (with +/- terminals shorted)																																									
Filter	Off, 2, 5, 10, 20, 40 Filter operation is on a moving average basis. The average value of the number of set samples is used. If the sample interval exceeds 30 seconds, the average value of data obtained in a sub-sample (30 seconds) is used.																																									

B-565 Specifications

Item	Description																																																																							
Number of input channels	20 channels (Up to 200 channels when using with the expansion terminal base) * Between GL860 and terminal and between terminals can be directly connected or with an expansion terminal connection cable (sold separately)																																																																							
Input terminal type	M3 screw-type terminals (Rectangular flat washer)																																																																							
Input method	Photo MOS relay scanning system All channels isolated, balanced input * Terminal b to be used to connect the Resistance bulb is shorted within all channels.																																																																							
Scan speed	5 ms/1 ch maximum																																																																							
Measurement ranges	Voltage: 20, 50, 100, 200, 500 mV, 1, 2, 5, 10, 20, 50, 100 V, 1-5 V F.S. Temperature Thermocouples: K, J, E, T, R, S, B, N, C (W: WRe5-26) Resistance bulb: Pt100, JPt100, Pt1000 (IEC751) Temperature range: 100°C, 500°C, 2000°C (In the case of Fahrenheit: 150°F, 750°F, 3000°F) Humidity: 0 to 100% (voltage 0 to 1 V scaling conversion) fixed																																																																							
Measurement accuracy (23°C ±5°C) • When 30 minutes or more have elapsed after power was switched on • Sampling 1 s/10 ch • Filter ON (10) • GND connected	Voltage: ± (0.05% of F.S. + 10μV) Temperature • Thermocouple <table border="1"> <thead> <tr> <th>Thermocouple</th> <th>Measurement Temperature Range (°C)</th> <th>Measurement Accuracy</th> </tr> </thead> <tbody> <tr> <td rowspan="4">R/S</td> <td>0 ≤ TS ≤ 100°C</td> <td>±4.5°C</td> </tr> <tr> <td>100 < TS ≤ 300°C</td> <td>±3.0°C</td> </tr> <tr> <td>R : 300 < TS ≤ 1600°C</td> <td>±2.2°C</td> </tr> <tr> <td>S : 300 < TS ≤ 1760°C</td> <td>±2.2°C</td> </tr> <tr> <td rowspan="2">B</td> <td>400 ≤ TS ≤ 600°C</td> <td>±3.5°C</td> </tr> <tr> <td>600 < TS ≤ 1820°C</td> <td>±2.5°C</td> </tr> <tr> <td rowspan="2">K</td> <td>-200 ≤ TS ≤ -100°C</td> <td>±1.5°C</td> </tr> <tr> <td>-100 < TS ≤ 1370°C</td> <td>±0.8°C</td> </tr> <tr> <td rowspan="2">E</td> <td>-200 ≤ TS ≤ -100°C</td> <td>±1.0°C</td> </tr> <tr> <td>-100 < TS ≤ 800°C</td> <td>±0.8°C</td> </tr> <tr> <td rowspan="2">T</td> <td>-200 ≤ TS ≤ -100°C</td> <td>±1.5°C</td> </tr> <tr> <td>-100 < TS ≤ 400°C</td> <td>±0.6°C</td> </tr> <tr> <td rowspan="3">J</td> <td>-200 ≤ TS ≤ -100°C</td> <td>±1.0°C</td> </tr> <tr> <td>-100 < TS ≤ 100°C</td> <td>±0.8°C</td> </tr> <tr> <td>100 < TS ≤ 1100°C</td> <td>±0.6°C</td> </tr> <tr> <td rowspan="2">N</td> <td>-200 ≤ TS < 0°C</td> <td>±2.2°C</td> </tr> <tr> <td>0 ≤ TS ≤ 1300°C</td> <td>±1.0°C</td> </tr> <tr> <td>C (W)</td> <td>0 ≤ TS ≤ 2000°C</td> <td>±1.8°C</td> </tr> </tbody> </table> <p>Reference contact compensation accuracy ±0.3°C</p> <p>* Thermocouple diameters T, K: 0.32 φ, others: 0.65 φ</p> <p>• Resistance bulb</p> <table border="1"> <thead> <tr> <th>Type</th> <th>Measurement Temperature Range (°C)</th> <th>Applied current</th> <th>Measurement</th> </tr> </thead> <tbody> <tr> <td rowspan="3">Pt100</td> <td>-200 ≤ TS ≤ 100°C</td> <td rowspan="3">1mA</td> <td>±0.6°C</td> </tr> <tr> <td>100 < TS ≤ 500°C</td> <td>±0.8°C</td> </tr> <tr> <td>500 < TS ≤ 850°C</td> <td>±1.0°C</td> </tr> <tr> <td rowspan="2">JPt100</td> <td>-200 ≤ TS ≤ 100°C</td> <td rowspan="2">1mA</td> <td>±0.6°C</td> </tr> <tr> <td>100 < TS ≤ 500°C</td> <td>±0.8°C</td> </tr> <tr> <td rowspan="2">Pt1000</td> <td>-200 ≤ TS ≤ 100°C</td> <td rowspan="2">0.3mA</td> <td>±0.6°C</td> </tr> <tr> <td>100 < TS ≤ 500°C</td> <td>±0.8°C</td> </tr> </tbody> </table> <p>* 3-wire system.</p>	Thermocouple	Measurement Temperature Range (°C)	Measurement Accuracy	R/S	0 ≤ TS ≤ 100°C	±4.5°C	100 < TS ≤ 300°C	±3.0°C	R : 300 < TS ≤ 1600°C	±2.2°C	S : 300 < TS ≤ 1760°C	±2.2°C	B	400 ≤ TS ≤ 600°C	±3.5°C	600 < TS ≤ 1820°C	±2.5°C	K	-200 ≤ TS ≤ -100°C	±1.5°C	-100 < TS ≤ 1370°C	±0.8°C	E	-200 ≤ TS ≤ -100°C	±1.0°C	-100 < TS ≤ 800°C	±0.8°C	T	-200 ≤ TS ≤ -100°C	±1.5°C	-100 < TS ≤ 400°C	±0.6°C	J	-200 ≤ TS ≤ -100°C	±1.0°C	-100 < TS ≤ 100°C	±0.8°C	100 < TS ≤ 1100°C	±0.6°C	N	-200 ≤ TS < 0°C	±2.2°C	0 ≤ TS ≤ 1300°C	±1.0°C	C (W)	0 ≤ TS ≤ 2000°C	±1.8°C	Type	Measurement Temperature Range (°C)	Applied current	Measurement	Pt100	-200 ≤ TS ≤ 100°C	1mA	±0.6°C	100 < TS ≤ 500°C	±0.8°C	500 < TS ≤ 850°C	±1.0°C	JPt100	-200 ≤ TS ≤ 100°C	1mA	±0.6°C	100 < TS ≤ 500°C	±0.8°C	Pt1000	-200 ≤ TS ≤ 100°C	0.3mA	±0.6°C	100 < TS ≤ 500°C	±0.8°C
Thermocouple	Measurement Temperature Range (°C)	Measurement Accuracy																																																																						
R/S	0 ≤ TS ≤ 100°C	±4.5°C																																																																						
	100 < TS ≤ 300°C	±3.0°C																																																																						
	R : 300 < TS ≤ 1600°C	±2.2°C																																																																						
	S : 300 < TS ≤ 1760°C	±2.2°C																																																																						
B	400 ≤ TS ≤ 600°C	±3.5°C																																																																						
	600 < TS ≤ 1820°C	±2.5°C																																																																						
K	-200 ≤ TS ≤ -100°C	±1.5°C																																																																						
	-100 < TS ≤ 1370°C	±0.8°C																																																																						
E	-200 ≤ TS ≤ -100°C	±1.0°C																																																																						
	-100 < TS ≤ 800°C	±0.8°C																																																																						
T	-200 ≤ TS ≤ -100°C	±1.5°C																																																																						
	-100 < TS ≤ 400°C	±0.6°C																																																																						
J	-200 ≤ TS ≤ -100°C	±1.0°C																																																																						
	-100 < TS ≤ 100°C	±0.8°C																																																																						
	100 < TS ≤ 1100°C	±0.6°C																																																																						
N	-200 ≤ TS < 0°C	±2.2°C																																																																						
	0 ≤ TS ≤ 1300°C	±1.0°C																																																																						
C (W)	0 ≤ TS ≤ 2000°C	±1.8°C																																																																						
Type	Measurement Temperature Range (°C)	Applied current	Measurement																																																																					
Pt100	-200 ≤ TS ≤ 100°C	1mA	±0.6°C																																																																					
	100 < TS ≤ 500°C		±0.8°C																																																																					
	500 < TS ≤ 850°C		±1.0°C																																																																					
JPt100	-200 ≤ TS ≤ 100°C	1mA	±0.6°C																																																																					
	100 < TS ≤ 500°C		±0.8°C																																																																					
Pt1000	-200 ≤ TS ≤ 100°C	0.3mA	±0.6°C																																																																					
	100 < TS ≤ 500°C		±0.8°C																																																																					

Item	Description																																																						
	<ul style="list-style-type: none"> Temperature range <table border="1"> <thead> <tr> <th>Type</th> <th>Temperature range</th> <th>Resolution</th> <th>Measurement Range</th> </tr> </thead> <tbody> <tr> <td rowspan="3">R/S</td> <td>100°C F.S.</td> <td>0.01°C</td> <td>0 to 100°C</td> </tr> <tr> <td>500°C F.S.</td> <td>0.05°C</td> <td>0 to 500°C</td> </tr> <tr> <td>2000°C F.S.</td> <td>0.1°C</td> <td>R : 0 to 1600°C S : 0 to 1760°C</td> </tr> <tr> <td rowspan="2">B</td> <td>500°C F.S.</td> <td>0.05°C</td> <td>400 to 500°C</td> </tr> <tr> <td>2000°C F.S.</td> <td>0.01°C</td> <td>500 to 1820°C</td> </tr> <tr> <td rowspan="4">K/E/T/J/N</td> <td>100°C F.S.</td> <td>0.01°C</td> <td>-100 to 100°C</td> </tr> <tr> <td>500°C F.S.</td> <td>0.05°C</td> <td>K/E/J/N: -200 to 500°C T: -200 to 400°C</td> </tr> <tr> <td rowspan="3">2000°C F.S.</td> <td rowspan="3">0.1°C</td> <td>K: -200 to 1370°C</td> </tr> <tr> <td>E: -200 to 800°C</td> </tr> <tr> <td>T: -200 to 400°C</td> </tr> <tr> <td rowspan="3">C (W)</td> <td>100°C F.S.</td> <td>0.01°C</td> <td>0 to 100°C</td> </tr> <tr> <td>500°C F.S.</td> <td>0.05°C</td> <td>0 to 500°C</td> </tr> <tr> <td>2000°C F.S.</td> <td>0.1°C</td> <td>0 to 2000°C</td> </tr> <tr> <td rowspan="4">Pt</td> <td>100°C F.S.</td> <td>0.01°C</td> <td>-100 to 100°C</td> </tr> <tr> <td>500°C F.S.</td> <td>0.05°C</td> <td>-200 to 500°C</td> </tr> <tr> <td rowspan="2">2000°C F.S.</td> <td rowspan="2">0.1°C</td> <td>Pt100: -200 to 850°C</td> </tr> <tr> <td>JPt100/Pt1000: -200 to 500°C</td> </tr> </tbody> </table> <p>* Measurement accuracy does not change due to the temperature range.</p>	Type	Temperature range	Resolution	Measurement Range	R/S	100°C F.S.	0.01°C	0 to 100°C	500°C F.S.	0.05°C	0 to 500°C	2000°C F.S.	0.1°C	R : 0 to 1600°C S : 0 to 1760°C	B	500°C F.S.	0.05°C	400 to 500°C	2000°C F.S.	0.01°C	500 to 1820°C	K/E/T/J/N	100°C F.S.	0.01°C	-100 to 100°C	500°C F.S.	0.05°C	K/E/J/N: -200 to 500°C T: -200 to 400°C	2000°C F.S.	0.1°C	K: -200 to 1370°C	E: -200 to 800°C	T: -200 to 400°C	C (W)	100°C F.S.	0.01°C	0 to 100°C	500°C F.S.	0.05°C	0 to 500°C	2000°C F.S.	0.1°C	0 to 2000°C	Pt	100°C F.S.	0.01°C	-100 to 100°C	500°C F.S.	0.05°C	-200 to 500°C	2000°C F.S.	0.1°C	Pt100: -200 to 850°C	JPt100/Pt1000: -200 to 500°C
Type	Temperature range	Resolution	Measurement Range																																																				
R/S	100°C F.S.	0.01°C	0 to 100°C																																																				
	500°C F.S.	0.05°C	0 to 500°C																																																				
	2000°C F.S.	0.1°C	R : 0 to 1600°C S : 0 to 1760°C																																																				
B	500°C F.S.	0.05°C	400 to 500°C																																																				
	2000°C F.S.	0.01°C	500 to 1820°C																																																				
K/E/T/J/N	100°C F.S.	0.01°C	-100 to 100°C																																																				
	500°C F.S.	0.05°C	K/E/J/N: -200 to 500°C T: -200 to 400°C																																																				
	2000°C F.S.	0.1°C	K: -200 to 1370°C																																																				
			E: -200 to 800°C																																																				
T: -200 to 400°C																																																							
C (W)	100°C F.S.	0.01°C	0 to 100°C																																																				
	500°C F.S.	0.05°C	0 to 500°C																																																				
	2000°C F.S.	0.1°C	0 to 2000°C																																																				
Pt	100°C F.S.	0.01°C	-100 to 100°C																																																				
	500°C F.S.	0.05°C	-200 to 500°C																																																				
	2000°C F.S.	0.1°C	Pt100: -200 to 850°C																																																				
			JPt100/Pt1000: -200 to 500°C																																																				
Reference contact compensation accuracy	Internal/External switching																																																						
A/D converter	Method: $\Delta\Sigma$ method Resolution: 16-bit (Effective resolution: About 1/40000 of the +/- range)																																																						
Temperature coefficient	Gain: 0.01% of F.S./°C Zero: 0.02% of F.S./°C * Zero occurs at the sampling of 5, 10, 20, and 50 ms.																																																						
Input resistance	1M Ω \pm 5%																																																						
Allowable signal source resistance	Within 100 Ω																																																						
Maximum permissible input voltage	Between +/- terminals: 20mV to 2V range (60Vp-p) 5V to 100V range (110Vp-p) Between input terminal/input terminal: 600 Vp-p Between input terminal/GND: 300 Vp-p																																																						
Withstand voltage	Between input terminal/input terminal: 600 Vp-p Between input terminal/GND: 2300 Vp-p 1 minute																																																						
Insulation resistance	Between input terminal/GND: 50M Ω or more (at 500 VDC)																																																						
Common mode rejection ratio	90 dB or more (50/60 Hz; signal source 300 Ω or less)																																																						
Noise	48 dB or more (with +/- terminals shorted)																																																						
Filter	Off, 2, 5, 10, 20, 40 Filter operation is on a moving average basis. The average value of the number of set samples is used. If the sample interval exceeds 30 seconds, the average value of data obtained in a sub-sample (30 seconds) is used.																																																						

5.2 Function Specifications

Function Specifications

Item	Description
Display screen	Waveform + Digital screen, All Waveform screen, Digital + Calculation Display screen, Expanded digital screen, Alarm history screen * Can be switched using the dedicated key. (toggle operation) * For the Expanded Digital screen, the number of channels and the display channel must be specified. * The waveform is not rewritten due to the change of the TIME / DIV.
Sampling interval	5 ms/1 ch maximum (GBD/CSV-formatted) 5, 10, 20, 50, 100, 125, 200, 250, 500 ms; 1, 2, 5, 10, 20, 30 sec.; 1, 2, 5, 10, 20, 30 min.; 1 hour; External * The settings of 1 sec or below can be used depending on the input settings and the measuring channel.
EU (scaling function)	<ul style="list-style-type: none"> • 4 points can be set for each channel • The temperature range scaling function is available.
Functions during capture	<ul style="list-style-type: none"> • Confirmation of the captured data (Switchable between 1-screen and 2-screen) • Saving of data between cursors • Replacement of the SD memory card
Data save function	Capture destination: Internal memory or SD memory card Captured data: Settings, Screen data, Measurement data, Alarm history data
Capture function	Function: OFF, Ring recording, Relay recording
Ring recording	Number of recording points: 1000 to 2000000 * When ring capture is ON, the memory space that can be used for capture is one-third of the free space.
Relay recording	Relay capacity: 100MB to 2000MB Relay time: 1 hour 00 minute to 24 hours 00 minutes The captured data is continuously captured by files separated in the set relay unit without losing data.
Replaying data	GBD/CSV-formatted data file (only data captured in this GL860)
Calculation between CHs	Calculation type: Four arithmetic operations (+, -, ×, ÷) Target input: Analog CH1 to CH200
Statistical calculation	Statistical calculation type: Average value, maximum value, minimum value, peak value, root mean square value Calculation method: Real-time calculation and specified between cursors (during replay) * Real-time calculation results are displayed on the Digital screen + Calculation Display screen.
Search functions	Function: Search the captured data for the required number of points Search type: Channel Pulse, Logic, Level, Alarm search
Annotation input function	Function: A comment can be entered for each channel Input table characters: Alphanumerics Number of characters: 31 (The number of characters can be displayed on the screen is up to eight characters.)
Navigation function	Easy capture measurement, easy trigger setting, wireless LAN setting functions

Trigger/Alarm Functions

Item	Description
Repeat Trigger	Off, On
Trigger types	Start: Data capture starts when a trigger is generated. Stop: Data capture stops when a trigger is generated.
Trigger conditions	Start: Off, Level, Alarm, External, Time, Date, Weekly Stop: Off, Level, Alarm, External, Time, Date, Weekly
Trigger judgment modes	Combination: Level OR, Level AND, Edge OR, Edge AND Analog channel judgment mode: H (↑), L (↓), Window In, Window Out Logic channel judgment mode: H (↑), L (↓) Pulse channel judgment mode: H (↑), L (↓), Window In, Window Out Calculation channel judgment mode: H (↑), L (↓), Window In, Window Out

Item	Description
Alarm judgment modes	Detection method: Level, Edge Analog channel judgment mode: H (↑), L (↓), Window In, Window Out Logic channel judgment mode: H (↑), L (↓) Pulse channel judgment mode: H (↑), L (↓), Window In, Window Out Calculation channel judgment mode: H (↑), L (↓), Window In, Window Out
Alarm History function	Off, On Alarm occurrence/cancellation history can be collected up to the latest 100 events. A cursor jump is possible from alarm history.

External Input/Output Functions

Item	Description
Input/output types	<ul style="list-style-type: none"> • Trigger input (1 ch) or External sampling input (1 ch) • Logic input (4 ch) or Pulse input (4 ch) • Alarm output (4 ch) * Switch between Logic and Pulse * Switch between Trigger and External sampling. * The Input/output cable for GL B-513 (option) is required to use the external output function.
Input specifications	Input voltage range: 0 to +24 V (single-ended ground input) Input signal: No-voltage contact (a-contact, b-contact, NO, NC), Open collector, Voltage input * Refer to "2.7 Connecting the Signal Input Cables" for details on the input circuit.
Alarm output specifications	Output format: Open collector output (5 V, pull-up resistance 10KΩ) <Maximum ratings of output transistor> <ul style="list-style-type: none"> • Collector-GND voltage: 30 V • Collector current: 0.5 A • Collector dissipation: 0.2 W * Refer to "2.7 Connecting the Signal Input Cables" for details on the output circuit. Output conditions: Level judgment, window judgment, logic pattern judgment, pulse judgment
Pulse input	Revolutions mode (engines, etc.) Function: This mode counts the number of pulses per sampling interval, and then converts them by multiplying the scaling factor by the RPM. Settable the number of pulses per revolution during revolution Spans: 50, 500, 5000, 50 k, 500 k, 5 M, 50 M, 500 M PRM/F.S.
	Counts mode (electric meters, etc.) Function: Displays a count of the number of pulses for each sampling interval from the start of measurement. Spans: 50, 500, 5000, 50 k, 500 k, 5 M, 50 M, 500 M C/F.S.
	Inst. mode Function: Counts the number of pulses for each sampling interval. Resets the count value after each sampling interval. Spans: 50, 500, 5000, 50 k, 500 k, 5 M, 50 M, 500 M C/F.S.
	Maximum number of pulse inputs Maximum input frequency: 50kHz Maximum number of count: 50kC/sampling (16-bit counter)

5.3 Accessories/Optional Accessories

Control Software

Item	Description
Compatible operating system	Windows 11 / Windows 10
Function	Main unit control, real-time data capture, data conversion
Number of groups	4 groups MAX
Number of CHs per 1 group	Up to the number of connected modules
Maximum number of channels	1000 ch maximum
Settings	AMP settings, capture settings, trigger/alarm settings, report settings, others
Captured data	Realtime data (CSV, GBD Binary) Data in Internal memory or SD memory card (CSV, GBD binary)
Display	Analog waveforms, logic waveforms, pulse waveforms, digital values
Display modes	Y-T View, Digital View, Report View, X-Y View between Cursors (only during replay), Integrated bar graph display
File conversion	Between cursors, All data
Monitor functions	The alarm monitor enables the sending of emails to the specified address
Statistic/History	Displays maximum, minimum and average values during measurement
Report function	Enables the creation of daily or monthly files
E-mail function	The e-mail is sent to the specified address when the alarm monitor is performed.

Accessories

Item	Description
Quick Start Guide	GL860-UM-80x: 1
AC adapter	100 to 240 VAC, 50/60 Hz, Power supply cord for each area: 1

Wireless Unit B-568 (Option)

Item	Description
Communication system	Wireless LAN
Installation	Attach to the wireless LAN connection terminal * When the wireless unit is inserted, the SD memory card cannot be inserted into the SD CARD slot.
Wireless LAN standard	IEEE802.11b/g/n
Function	Control from PC, data transfer to PC, control and data transfer from smartphone/tablet For access point: Local control and transfer are possible. For station: In addition to local, remote control and transfer using G-REMOTE is also possible. Communication range: Approx. 40 m * Communication range depends on the obstacles and the surrounding environmental conditions. WPS: Push button method / PIN method Encryption function: WEP64, WEP128, WPA-PSK/WPA 2-PSK (TKIP/AES) * WPA/WPA2 and TKIP/AES are automatically selected.

Battery Pack B-573 (Option)

Item	Description
Capacity	7.2V/2875mAh
Battery type	Lithium secondary battery
Running time	Up to two packs can be mounted <When LCD is ON> Battery pack x 1 (brightness MAX): approx. 3 hours Battery pack x 2 (brightness MIN): approx. 6 hours <When LCD is OFF> Battery pack x 1: approx. 5 hours Battery pack x 2: approx. 10 hours * 20 channel terminals, 1-sec sampling, capturing to internal memory, new battery pack, and +25°C environment. * The running time depends on the operating environment. * It cannot be used for the following products and discontinued products. GL240/GL840/GL980/GL2000
Charging method	Mount in the main unit
Time required for charging	Battery pack x 1: approx. 5 hours Battery pack x 2: approx. 10 hours
Switchover in the event of a power failure	Because the battery is used together with the AC adapter, the power supply will be switched automatically to the battery in the event of a power failure. * The AC adapter is the primary power source.
Operation environment	Running on battery: 0 to 40°C, Battery being charged: 15 to 35°C
Other functions	<ul style="list-style-type: none"> When the battery is running low, the file is closed automatically. Remaining amount indicator

Humidity Sensor B-530 (Option)

Item	Description																		
Allowable temperature range	-25 to +80°C																		
Allowable humidity range	0 to 100% RH																		
Relative humidity measurement accuracy	±3% RH (5 to 98% RH at 25°C)																		
Method	Capacitance method																		
Relative humidity measurement accuracy (5 to 98%)	<table border="1"> <thead> <tr> <th>Measurement environment</th> <th>Measurement accuracy</th> </tr> </thead> <tbody> <tr> <td>0 to 10°C</td> <td>±5% RH</td> </tr> <tr> <td>10 to 20°C</td> <td>±4% RH</td> </tr> <tr> <td>20 to 30°C</td> <td>±3% RH</td> </tr> <tr> <td>30 to 40°C</td> <td>±4% RH</td> </tr> <tr> <td>40 to 50°C</td> <td>±5% RH</td> </tr> <tr> <td>50 to 60°C</td> <td>±6% RH</td> </tr> <tr> <td>60 to 70°C</td> <td>±7% RH</td> </tr> <tr> <td>70 to 80°C</td> <td>±8% RH</td> </tr> </tbody> </table> <p>* Measurement accuracy at 60°C or more is a reference value.</p>	Measurement environment	Measurement accuracy	0 to 10°C	±5% RH	10 to 20°C	±4% RH	20 to 30°C	±3% RH	30 to 40°C	±4% RH	40 to 50°C	±5% RH	50 to 60°C	±6% RH	60 to 70°C	±7% RH	70 to 80°C	±8% RH
Measurement environment	Measurement accuracy																		
0 to 10°C	±5% RH																		
10 to 20°C	±4% RH																		
20 to 30°C	±3% RH																		
30 to 40°C	±4% RH																		
40 to 50°C	±5% RH																		
50 to 60°C	±6% RH																		
60 to 70°C	±7% RH																		
70 to 80°C	±8% RH																		
Response time	15 sec. (90% response when membrane filter is installed)																		
Sensor output	0 to 1 VDC																		
External dimensions	φ14 × 80 mm (excluding cable)																		
Cable length	3 m																		
Sensor power source	DC +5 to +16 V																		
Power consumption	approx. 4 mA																		

List of Options

Item	Model	Description
Input/output cable for GL	B-513	2 m long (no clip on end of cable)
DC drive cable	B-514	2 m long (no clip on end of cable)
Humidity sensor *1	B-530	3 m long (with power plug)
Standard 20CH screw terminal	B-563	20CH standard terminal
Standard 20CH screwless terminal	B-563SL	20CH screwless terminal
Standard 30CH screwless terminal	B-563SL-30	30CH screwless terminal
Withstand high-voltage high-precision terminal	B-565	20CH Withstand high-voltage high-precision terminal
Base unit for input terminal	B-566	Extension terminal base unit, connection plate, screws
Connection cable for extension terminal	B-567-05	Connection cable (50 cm)
	B-567-20	Connection cable (2 m)
Wireless unit	B-568	Wireless LAN
Battery pack	B-573	7.2V/2875mAh
Bracket for DIN rail (GL860 main body)	B-570	Built to order
Bracket for DIN rail	B-540	Built to order
Shunt resistor	B-551	Built to order. 250 Ω, Rated power of 1 W, Maximum service voltage of 15.8 V
Input terminal cover	B-588	Protective cover

*1: Allowable temperature range: -25 to +80°C

5.4 External Dimensions

GL860 Standard 20CH screw terminal (B-563)

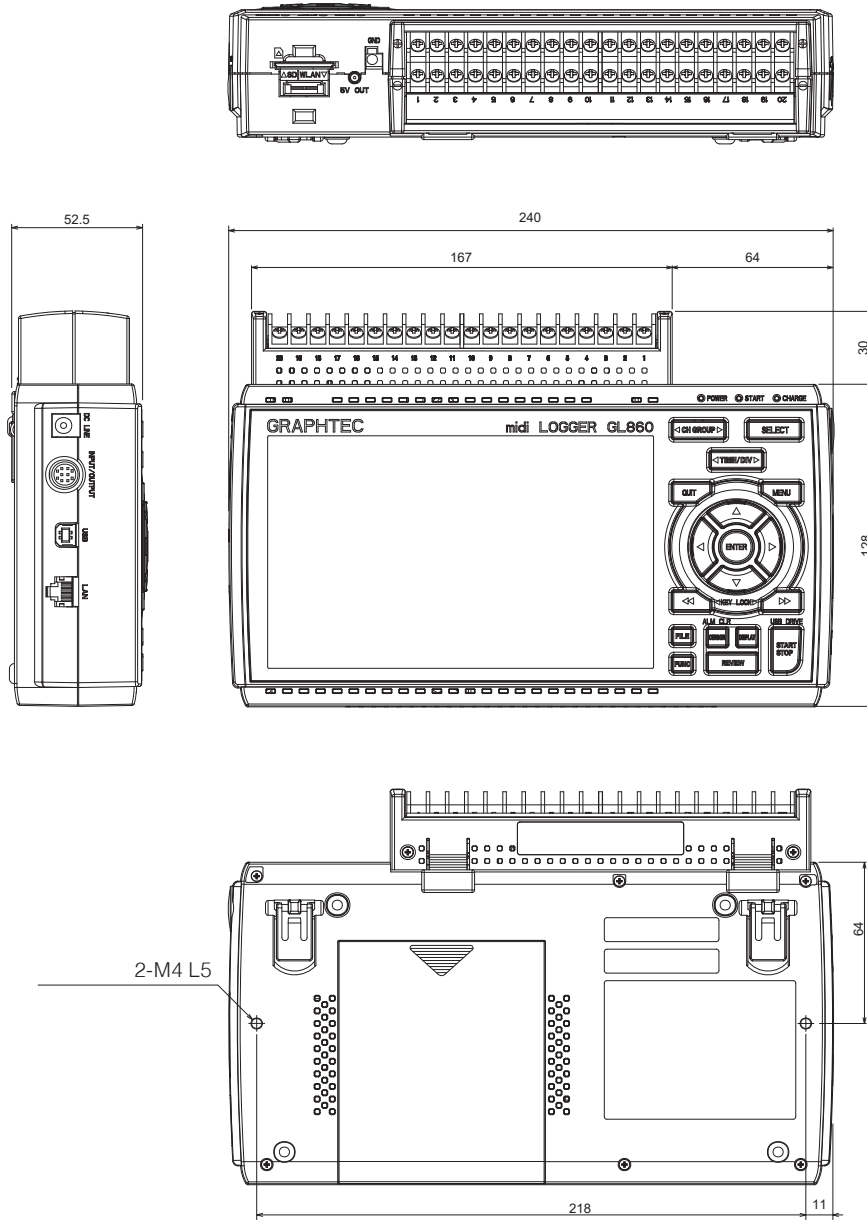

Unit: mm
Dimension precision: ± 3 mm

Terminals

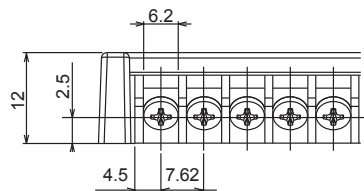

Unit: mm
Dimension precision: ± 0.5 mm

GL860 Standard 20CH screwless terminal (B-563SL)

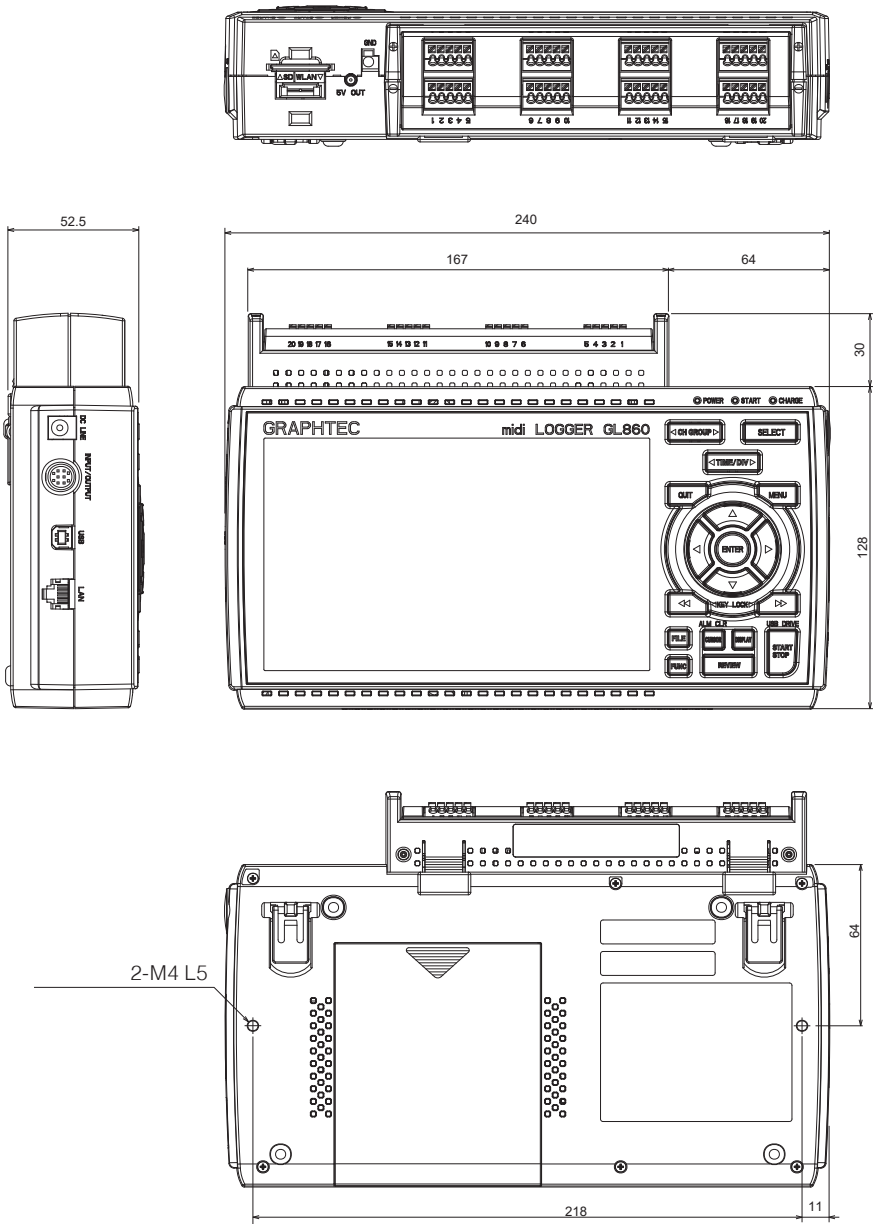

Unit: mm
Dimension precision: ± 3 mm

GL860 Standard 30CH screwless terminal (B-563SL-30)

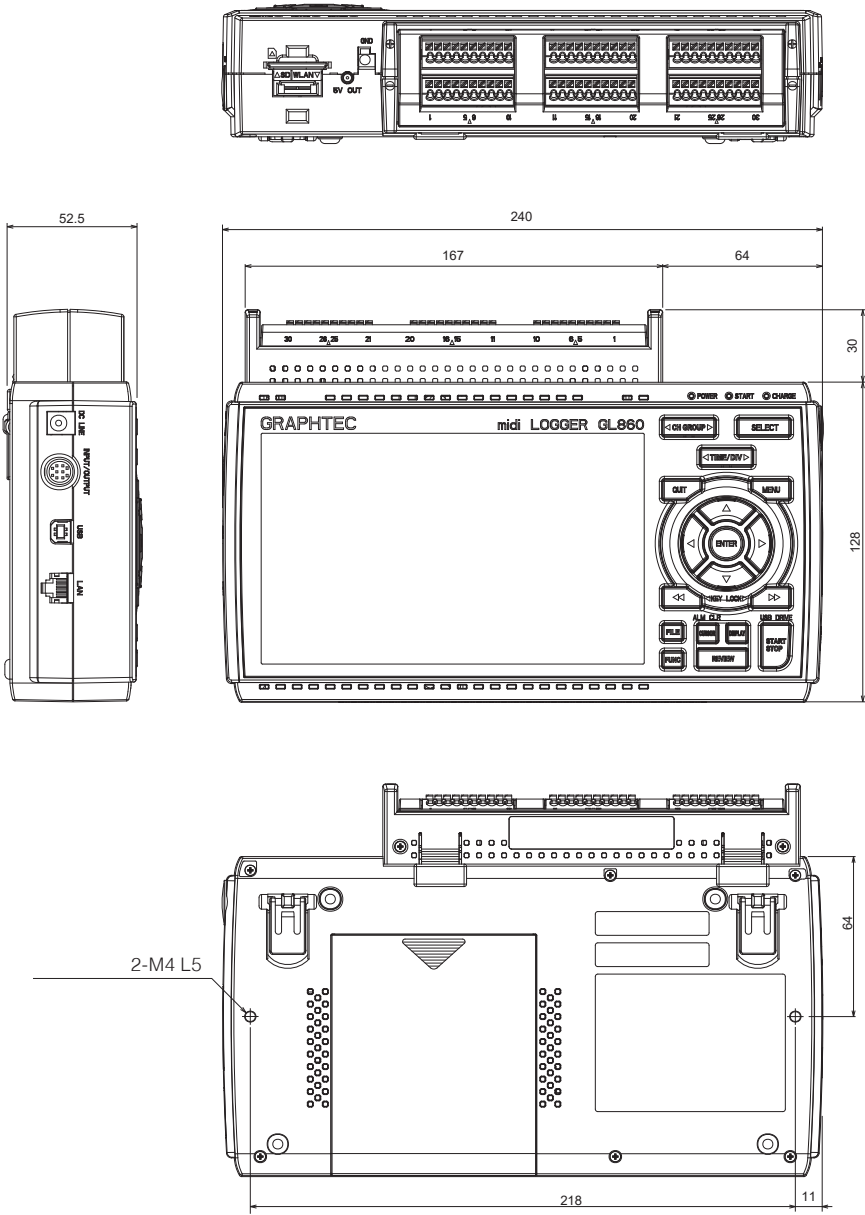

Unit: mm
Dimension precision: ± 3 mm

GL860 Withstand high-voltage high-precision terminal (B-565)

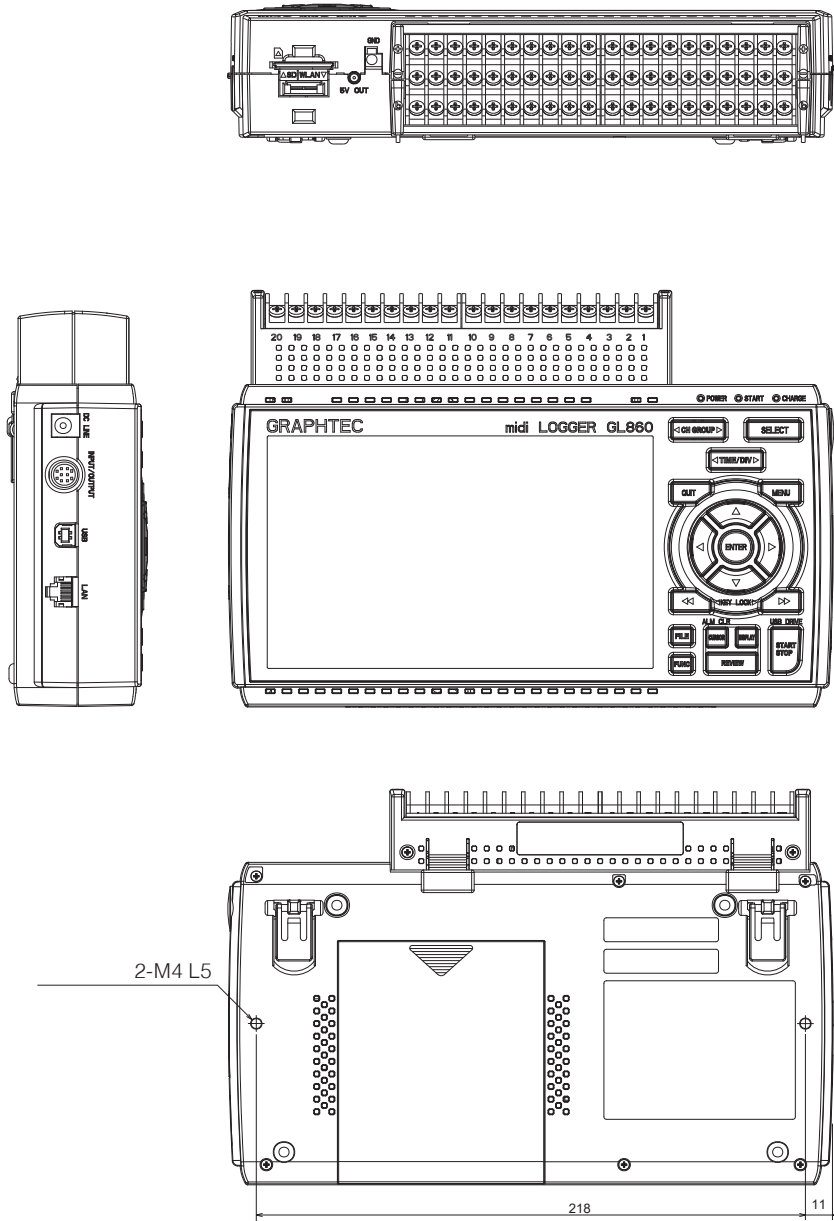

Unit: mm
Dimension precision: 3 mm

Terminals

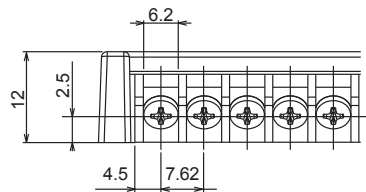

Unit: mm
Dimension precision: ± 0.5 mm

Specifications are subject to change without notice.

GL860 User's Manual

GL860-UM-151

July 31, 2024 1st edition-02

GRAPHTEC CORPORATION

GRAPHTEC