

# DI-4730 Industrial USB/Ethernet Data Acquisition (DAQ) and Data Logger System



- ✓ Eight isolated analog differential inputs
- ✓ Programmable range per channel:  $\pm 10\text{mV}$ ,  $\pm 100\text{mV}$ ,  $\pm 1\text{V}$ ,  $\pm 10\text{V}$ ,  $\pm 100\text{V}$ ,  $\pm 1000\text{V}$  full scale
- ✓ Supports ChannelStretch™ multi-unit synchronization\*
- ✓ PC-connected or Stand-alone operation to removable USB flash drive\*
- ✓ Supports USB, Ethernet, and Power over Ethernet interfaces
- ✓ Adaptable low-pass filter per channel
- ✓ Corner frequency set as a function of sampling rate
- ✓ 16-bit analog-to-digital resolution
- ✓ 160 kHz analog sample throughput rate
- ✓ Seven digital input ports
  - ✓ WinDaq Remote function support
  - ✓ Support for rate measurements to 50 kHz
  - ✓ Support for 16-bit counter
- ✓ Wide-ranging software support includes:
  - ✓ Ready-to-run WinDaq software
  - ✓ Published protocol for software development in non-Windows operating systems
  - ✓ Sample programs widely available in multiple coding languages

\* WinDaq/Pro unlock code required per device to use ChannelStretch™ with WinDaq software or for Stand-alone recording to removable USB flash drive.

## Overview

The DI-4730 is the next-generation of our very popular DI-730 series. The two are functionally identical except that the DI-4730 supports both [ChannelStretch™ channel expansion](#) and stand-alone data logging to a removable USB flash drive (unlock code required). Suitable for a wide range of analog and discrete measurements, the DI-4730, in tandem with the included WinDaq software, allows real time data acquisition, playback, and analysis performance that covers an incredibly broad array of applications in both laboratory and industrial settings. With all eleven scan list items enabled (8 analog channels, one each counter and rate, and all discrete input ports in the remaining position) a total sample throughput rate of 220 kHz is supported.

## Analog Subsystem

Eight analog input channels provide differential measurement flexibility and programmable ranges per channel of  $\pm 10\text{mV}$ ,  $\pm 100\text{mV}$ ,  $\pm 1\text{V}$ ,  $\pm 10\text{V}$ ,  $\pm 100$ , and  $\pm 1000\text{V}$  full scale. The front end feeds a variable resolution analog-to-digital converter that ranges from 12 to 16 bits as a function of sampling rate. Lower sampling rates deliver higher resolution readings. Rounding off the analog subsystem are low-pass filters per channel with automatic corner frequency selection as a function of sampling rate. All these features combine to provide pure data acquisition power at an unmatched price point.

## Digital Subsystem

The DI-4730 provides 7 digital inputs with protection to 25 V. Two ports allow dual functionality as discrete inputs, or can be programmed as a counter or rate input respectively. The rate input features a 50 kHz maximum measurement, allocated over twelve programmable measurement ranges (10 Hz to 50 kHz full scale.) The counter input provides 16-bit resolution and a terminal count value of 65,535. The discrete, counter, and rate inputs are members of the same internal scan list used by the analog input channels. This means that all enabled elements are acquired synchronously, which allows meaningful comparisons between analog and digital channels. For example, the rate input measuring engine speed allows rpm data to be acquired in lock-step with analog data.

## Stand-alone Operation

A USB drive is used to record data in stand-alone mode. The DI-4730 can record continuously using a circular buffer with pre-defined trigger conditions or a record-until-full approach supporting remote start/stop. A push button allows manual start/stop control over the recording process. With a flash memory card incorporating SLC technology, throughput rates up to 160 kHz can be achieved. That rate drops to 50 kHz when using pSLC card, and 20 kHz using a flash memory card incorporating MLC. The included WinDaq data acquisition software makes configuring the DI-4730 for stand-alone operation quick and intuitive. Alternatively, use WinDaq to set up channels and create a reference file. That reference file can then be copied to the USB drive and used for quick setup.

## Software Overview

Model DI-4730 is provided with comprehensive software support. For point-and-click, ready-to-run applications the DI-4730 is supplied with our popular WinDaq software. WinDaq allows a real time display of any combination of analog channels, and the ability to stream acquired data to disk in recorder-like fashion, even at the fastest rate supported by the hardware. This is true streaming performance, continuous, without gaps, and simultaneously to both the real time display and disk. Record only a few readings, or as many as 4 GB. The DI-4730 reserves two digital inputs for WinDaq software that are dedicated for remote stop/start and remote event operations. WinDaq also includes software to review recorded data files, including waveform analysis and data file export to Microsoft Excel and other applications. Custom programming the DI-4730 is supported by a fully published and supported protocol document.

## Interface Options

The DI-4730 provides three interface options (all 3 are installed and available): USB, Ethernet, and Power over Ethernet (PoE).

USB allows for quick plug-and-play access to your DI-4730. Using ChannelStretch™ technology, and cascading multiple USB hubs, add up to 15 additional instruments (a total of 128 analog channels and 105 digital ports) with a maximum throughput sample rate  $\geq 480\text{ kHz}$ .

Ethernet allows you to access your DI-4730 over much greater distances (up to 100 meters between stations). Connect directly to a PC, to a LAN port, or wirelessly using an access point. Using wireless hubs and ChannelStretch™ technology, you can add up to 15 additional units at throughput sample rates  $\geq 50\text{ kHz}$ .

Power over Ethernet (PoE) provides power to the DI-4730 using a PoE-enabled switch. This eliminates the costly expense of running power to a remote location where data acquisition may be essential.

### **Eight Analog Input Channels**

Measure as many as eight system variables at once with programmable ranges per channel of  $\pm 10\text{mV}$ ,  $\pm 100\text{mV}$ ,  $\pm 1\text{V}$ ,  $\pm 10\text{V}$ ,  $\pm 100\text{V}$ ,  $\pm 1000\text{V}$  full scale with channel-to-channel and input-to-output isolation. Replace entire racks of isolation amps, high and low voltage amps, and data acquisition subsystems with one, portable, lightweight instrument. Channel-to-channel isolation protects delicate control circuits, computer equipment, and personnel from high common mode voltages.

### **12- to 16-bit Measurement Resolution**

One product addresses your measurement needs, from low to high resolution, as a function of sampling rate.

### **Fully Isolated Inputs**

Analog inputs are protected to  $\pm 1000\text{V}$  input-to-output and channel-to-channel. Digital inputs are protected at 0-25 V dc.

### **Fast 160 kHz Sample Throughput Rate**

Observe fast phenomena with high sample rates up to 160kHz when recording to PC or removable USB thumb drive.

### **Stand-alone Data Logger Operation**

Store data to removable USB flash drives.

### **Pre/Post Trigger Storage to USB Memory**

Set trigger levels to record up to 2G (combined) of pre- and post-trigger data (total file size of 4G)

### **Auto Re-Trigger**

When using Triggered Storage, triggers can automatically reset, creating a new file with pre and post trigger data each time the trigger level is breached.

### **Comprehensive Published Protocol**

Program in any environment or operating system with our fully documented and comprehensive protocol document. Numerous programming examples are available and maintained on our GitHub page to help programmers of any level get up and running as quickly as possible.

### **Supports Channel Expansion**

Connect as many as sixteen DI-4108s, DI-4208s, DI-4718Bs, and/or DI-4730s to one PC. Synchronously acquire from as many as 128 and 112 analog and digital channels respectively. Note: WinDaq/Pro Unlock Code required per device to use Channel-Stretch™. Expand measurement capability using a mix of any device in the DI-4000 Series.

### **Seven Digital Input Ports**

Folds discrete inputs into the measurements process. Use each port as a general-purpose input or a specified WinDaq-designated function.

### **Counter Channel**

Tallies the number of pulses applied. Useful for integrating rate information, like flow rate to volume, or simply the number of definable events.

### **Rate Measurement Channel**

Measures pulse rate where frequency carries information. For example rpm or flow measurements.

### **USB, Ethernet, and PoE Interfaces Included**

Use a USB, Ethernet, or PoE interface on any DI-4730. Use Power over Ethernet to both communicate with and power the DI-4730 via the Ethernet connector, sparing the inconvenience and expense of running power to the unit.

### **Ready-to-run Software Support**

Provided with ready-to-run WinDaq software for point-and-click DAQ performance with a real-time display, disk-streaming recording, and playback and analysis.

## DI-4730 Front Panel Close-up



**Analog In Channels 1-8**  
 $\pm 10\text{mV}$ ,  $\pm 100\text{mV}$ ,  $\pm 1\text{V}$ ,  $\pm 10\text{V}$ ,  $\pm 100\text{V}$ ,  $\pm 1000\text{V}$ ,  $\pm 1000\text{V}$  Max.

## DI-4730 Rear Panel Close-up

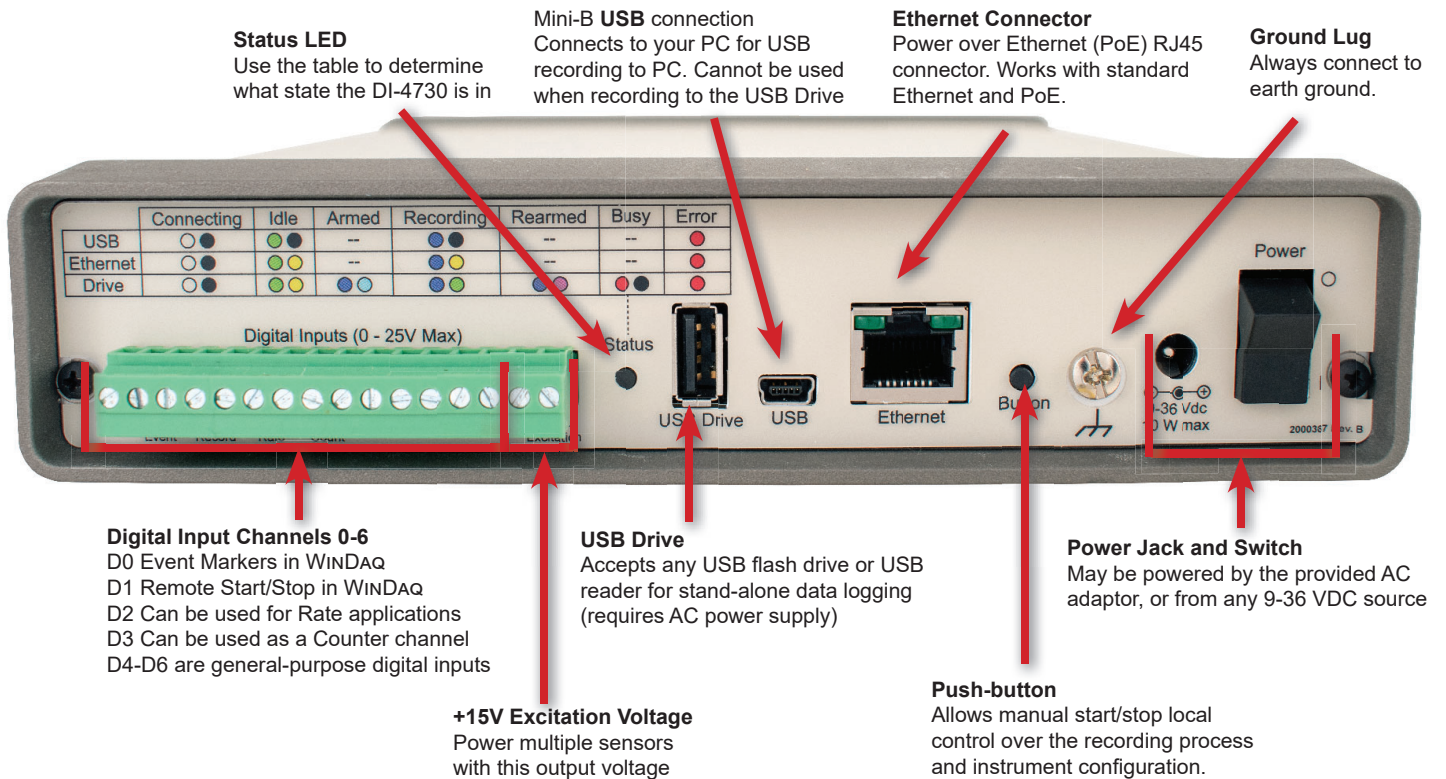

# DI-4730 Dimensional Drawing

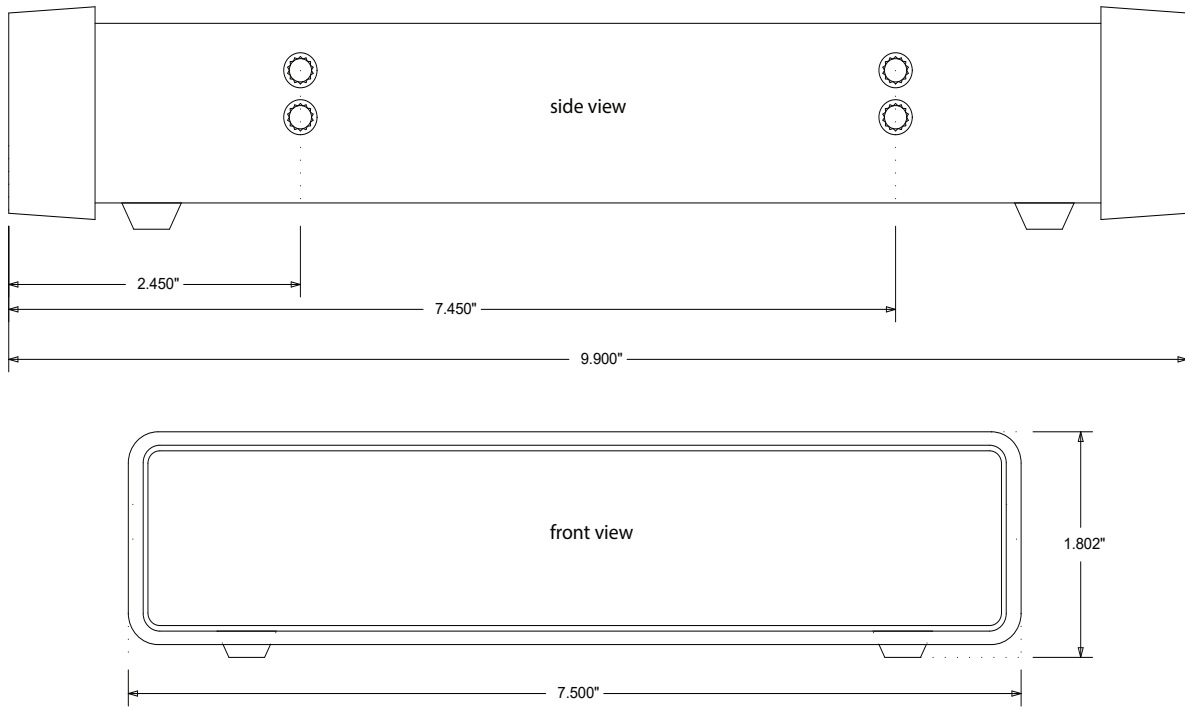

# DI-4730 Block Diagram

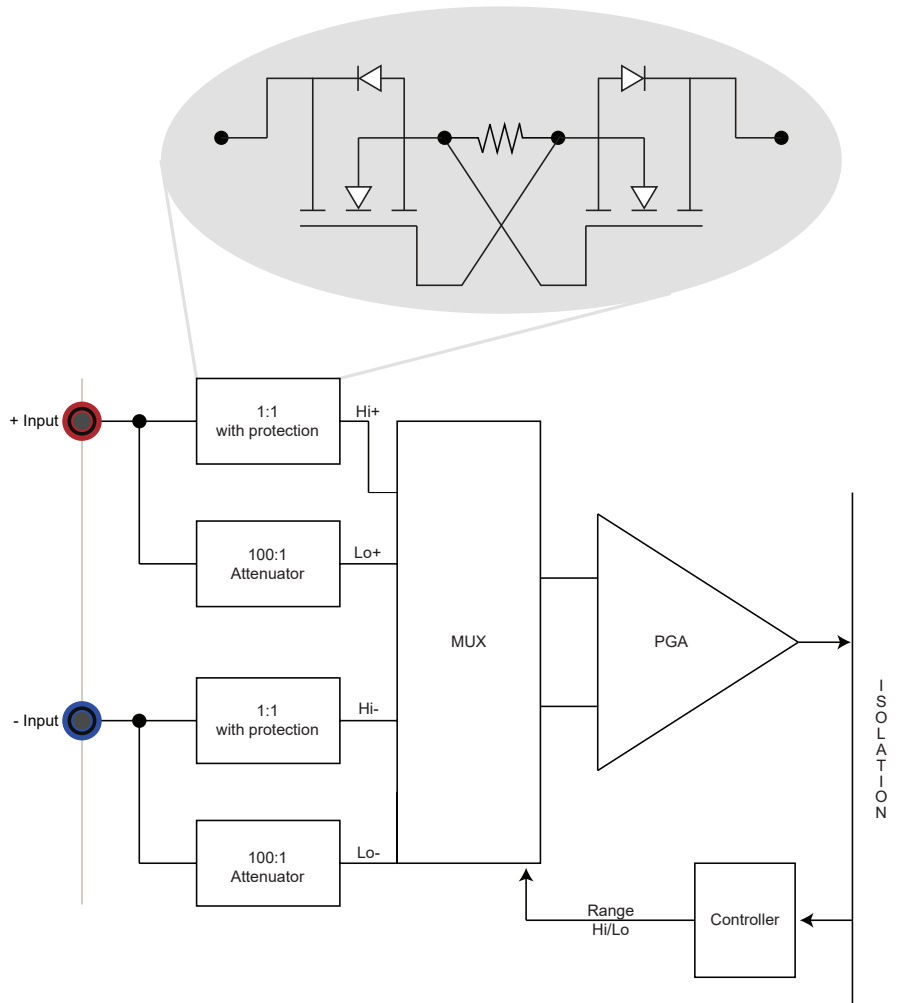

## Anti-alias Filter Architecture

The DI-4730 employs an anti-alias filter per analog channel with automatic corner frequency selection. The filter is a CIC (cascaded integrator comb) type that applies as many as 512 samples per channel to calculate filter results in real time. Filter response is optimized when sampling frequency is set to ten times the highest frequency of interest.

Typical Anti-alias Filter Frequency Response

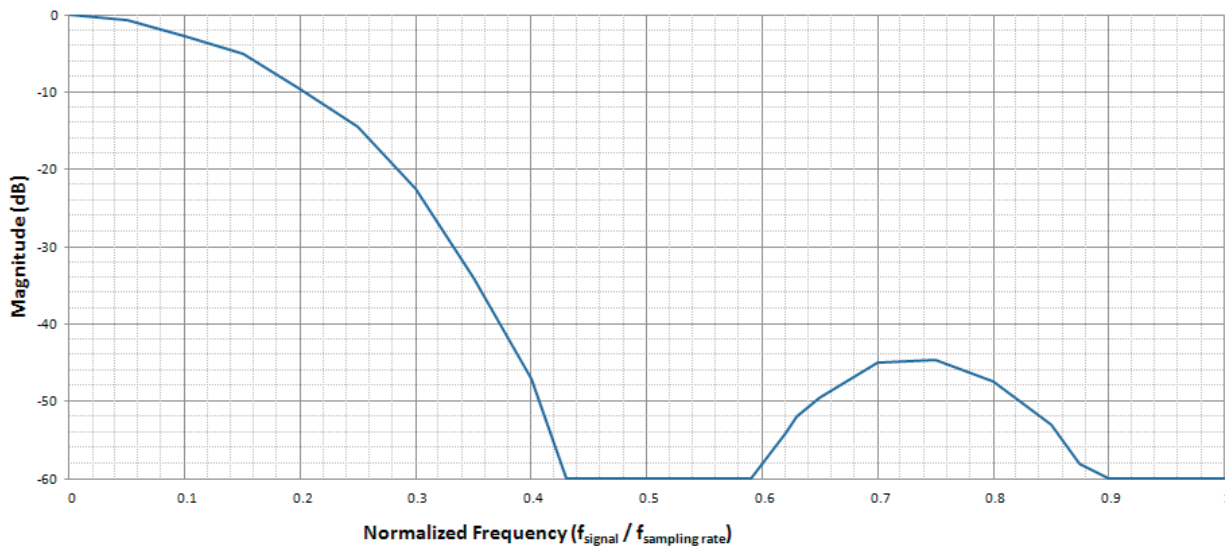

## DI-4730 Scan List Flexibility

The DI-4730 maintains an internal scan list of as many as eleven different items at once: eight analog channels, one each rate and count channels, and a single position to read the state of all digital ports. The scan list can be populated with any combination of analog input channels and digital input ports, including the rate and count channels. Maximum throughput of items in the scan list is 160 kHz for analog channels, increasing to 220 kHz after adding all discrete and pulse inputs to the scan list for a maximum sample rate of 20 kHz per element.

Item	Scan List Positions	Comments
Analog channels	Up to eight	One scan list position is consumed for each enabled analog channel. The scan entry defines the physical channel number and the full scale range of the measurement.
Digital inputs	One	All seven digital ports are read simultaneously with one entry in the scan list.
Counter input	One	One scan list position reserved for the counter input.
Rate input	One	One scan list position reserved for the rate input.

## Analog-to-digital Converter Characteristics

DI-4730 ADC resolution is a function of sampling rate: Slower sampling rates yield higher resolution measurements. The DI-4730 achieves this using its real time CIC decimation filter to improve signal-to-noise ratio and to increase measurement resolution.

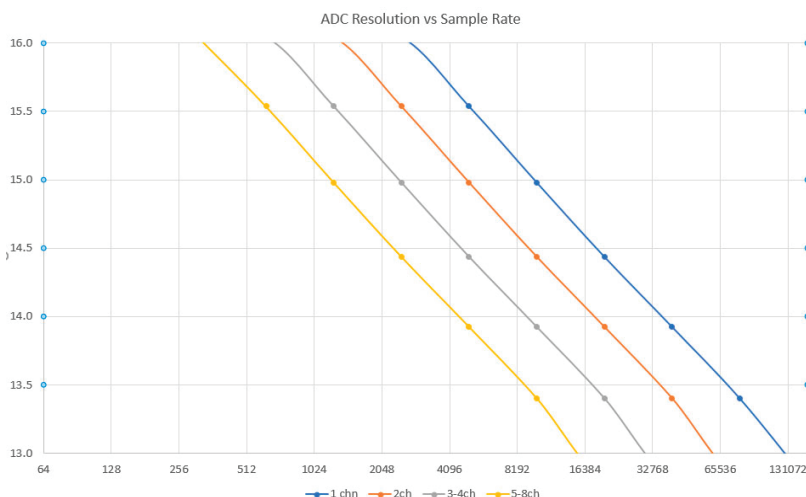

ADC resolution (R) is a function of selected sample rate per channel (F), and the number of enabled analog channels (C):

$$R = \frac{\log\left(\frac{160000}{FC}\right)}{\log(4)} + 12$$

Where:

C	Enabled Channels
1	1
2	2
4	3-4
8	5-8

## DI-4730 Analog Measurements

Eight analog input channels each with a programmable measurement range of  $\pm 10\text{mV}$ ,  $\pm 100\text{mV}$ ,  $\pm 1\text{V}$ ,  $\pm 10\text{V}$ ,  $\pm 100\text{V}$ , and  $\pm 1000\text{V}$  full scale are supported by the DI-4730. Each channel provides  $\pm 1000\text{V}$  input-to-output and channel-to-channel isolation.

### Application Example: Variable Speed Drive Motors

Motors using variable speed drives are found at virtually all levels of production, from mining raw materials and processing them into finished goods, to transporting those to market. Examples include open pit mining machines, steel and steel rolling mills, aluminum rolling mills, paper mills, heavy duty cranes, heavy duty construction equipment, electric locomotion by rail and sea, and high speed transit cars. In these applications and many more, the costs associated with system down time caused by a motor or drive failure can be severe. For this reason

motor and drive maintenance and troubleshooting is a major activity in many industries, and our DI-730 is the first PC-based product designed specifically for these and other demanding measurements that require isolation and wide dynamic range. The following diagram shows a variety of typical measurements made by our customers every day on variable speed drives using our model DI-730 data acquisition hardware. Each represents a direct-connected measurement without applying external isolators, dividers, or amplifiers.

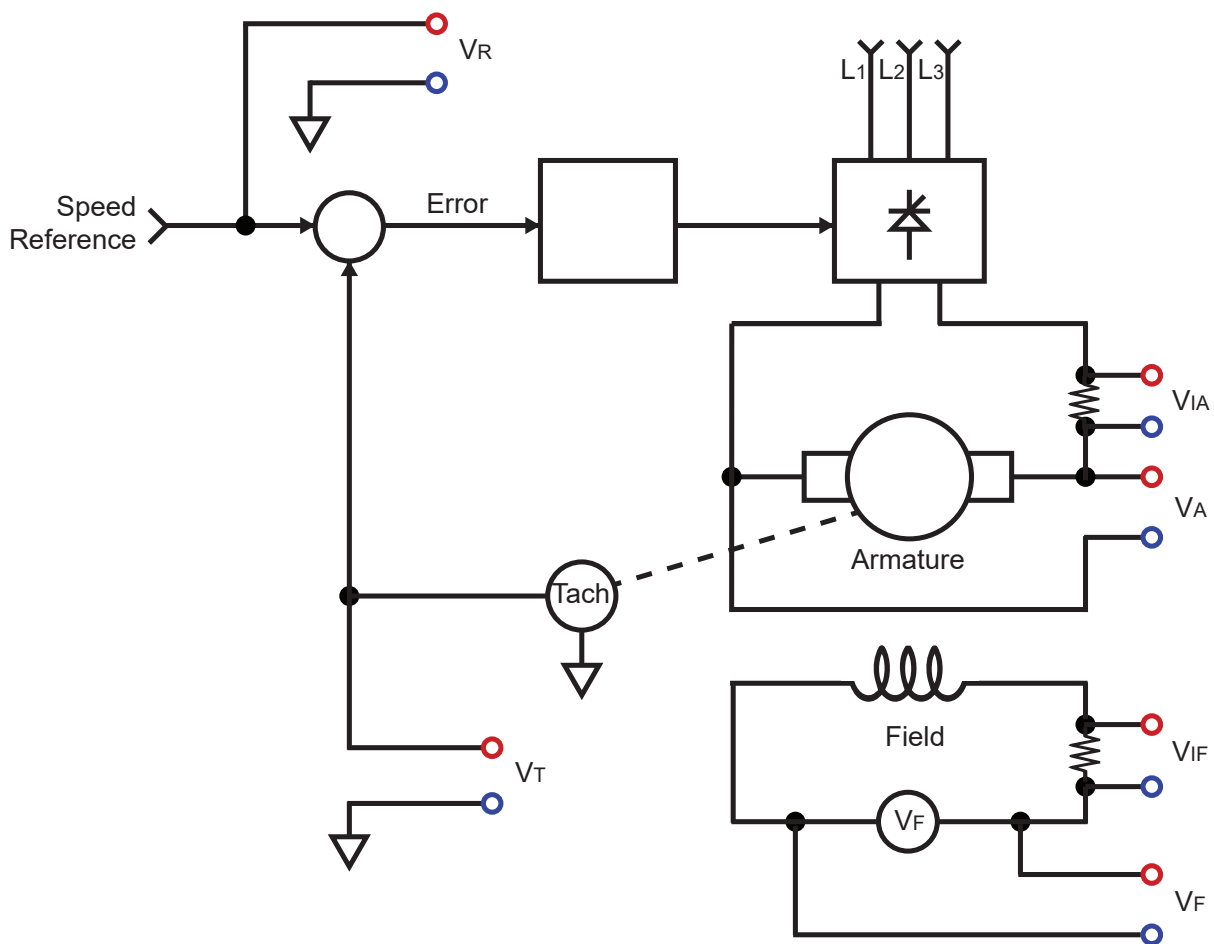

**Typical Signal Levels**

Symbol	Measurement	Source	Range	Calibrated Range
VIA	Armature Current	Shunt	$\pm 100\text{ mV}$	100-2000 A
VA	Armature Voltage	Direct	0-500 V	0-500 V
VIF	Field Current	Shunt	10-50 mV	0-20 A
VF	Field Voltage	Direct	0-300 V	0-300 V
VR	Speed Reference	Direct	0-10 V	0-4000 RPM
VT	Tachometer	Direct	0-200 V*	0-4000 RPM

## Application Close up: Steel rolling mill

In the United States, more electric motors are in use than there are people. Motors can be found at virtually all levels of production, from mining raw materials and processing them into finished goods, to transporting these to market. Examples include open pit mining machines, steel and steel rolling mills, aluminum rolling mills, paper mills, heavy duty cranes, heavy duty construction equipment, electric locomotion by rail and sea, and high speed transit cars. In these applications, the costs associated with system down time caused by a motor failure can be severe.

Therefore, motor maintenance and troubleshooting is a major activity in many industries across the country, and the DI-730 is the first PC-based product designed specifically for these and other demanding measurements that require isolation and wide dynamic range. The diagram below, illustrating a steel rolling mill, is just one of a multitude of electric motor applications that benefit from the level of integration, safety, and dynamic range provided by the DI-4730. Further detail is provided in the chart titled Typical Signal Levels.

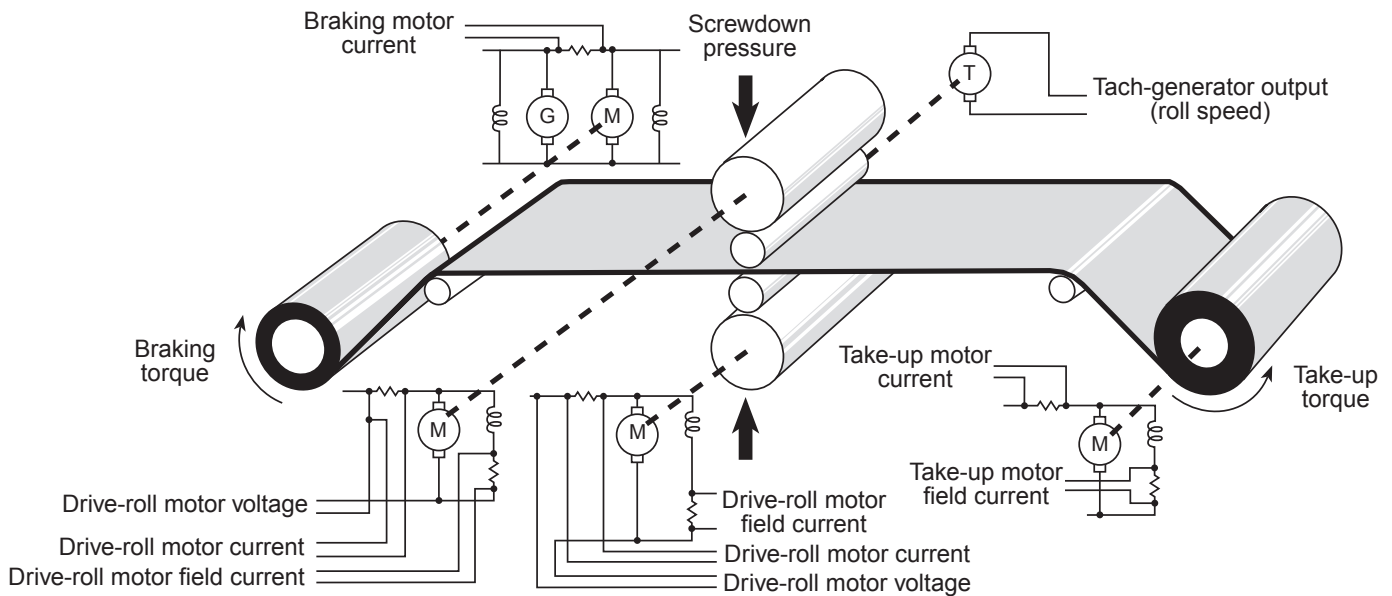

Typical Signal Levels		
Measurement	Source	Typical Level
Motor field currents	Shunt	50mV
Motor source currents	Shunt	50mV
Motor source voltages	Direct	700V
Tachometer (RPM)	Direct	100V
Torques	Transducer	20mV
Screwdown pressure	Load cell	20mV



## DI-4730 Digital Inputs

Seven digital input ports bring discrete inputs into the measurements process. Use each port as a general-purpose input or a specified WinDaq-designated function.

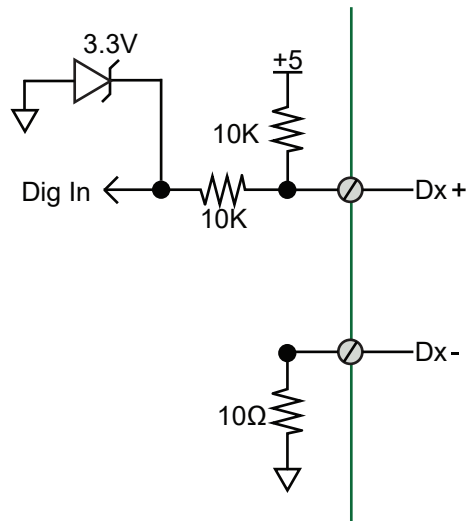

## DI-4730 Rate and Count Measurements

Port D2 can be programmed as a rate input and port D3 as a counter input. When programmed to measure rate and/or count the DI-4730 adds these measurements to its internal scan list along with any other analog or digital data so that all measurements are acquired in the same time frame. Rate measurements in the range of 10 Hz to 50 kHz are possible across twelve programmable full scale ranges. Use the rate input to extract rpm data from a rotating device, or to acquire flow information from a pulse-type flow sensor. Count measurements up to 65,536 are supported by the D3 port. Use count to integrate flow to get volume, or use it simply to tally events in a given process.

### Rpm from rate

The DI-4730's Rate input is used to acquire a frequency representing rpm, flow, or any other pulse stream.

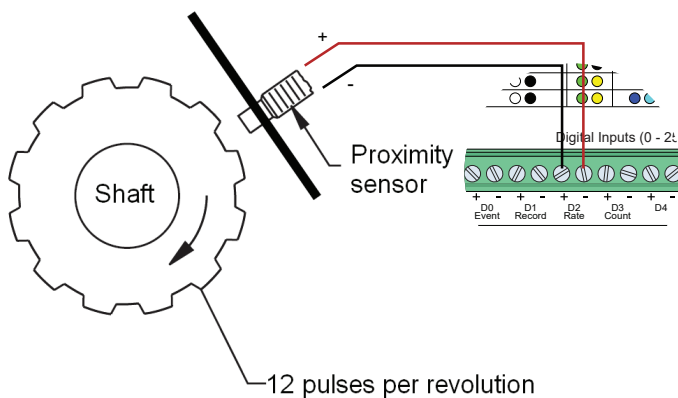

### Flow/volume

Use the DI-4730's Count input to accumulate a tally of applied discrete pulses to track test cycles, extract volume from flow, or any other general-purpose totalizing application.

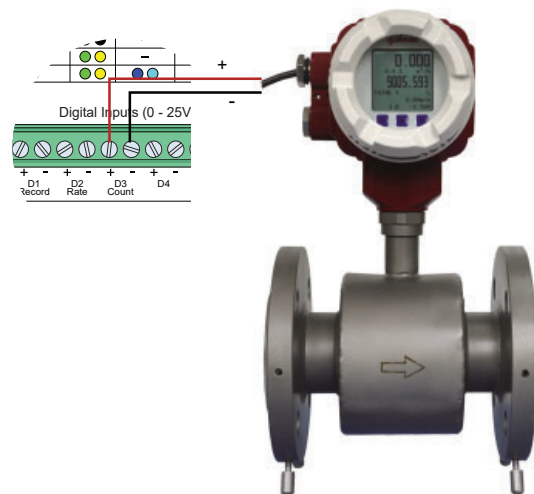

# Remote Control Close Up

The DI-4730 supports several methods to increase measurement flexibility and data record interpretation using the D0 and D1 Digital ports. The Remote Record (D1) feature allows you to synchronize WinDaq recordings to external processes by remotely enabling and disabling WinDaq's stream-to-disk feature. Remote Events (D0) allow you to insert an event marker in the data stream to identify when an event occurred relative to recorded waveform activity. Events can be activated by the pushbutton on the DI-4730 enclosure, though a keyboard keystroke (which also allows you to record a description), or remotely via the remote event input. The stream-to-disk function can also be controlled through the keyboard, or through the remote record input. Valid remote record and event signals are switch closures or discrete levels with a maximum input of 25 V. Finally, each port is internally pulled-up, so it's easy to use with external dry-contact switches.

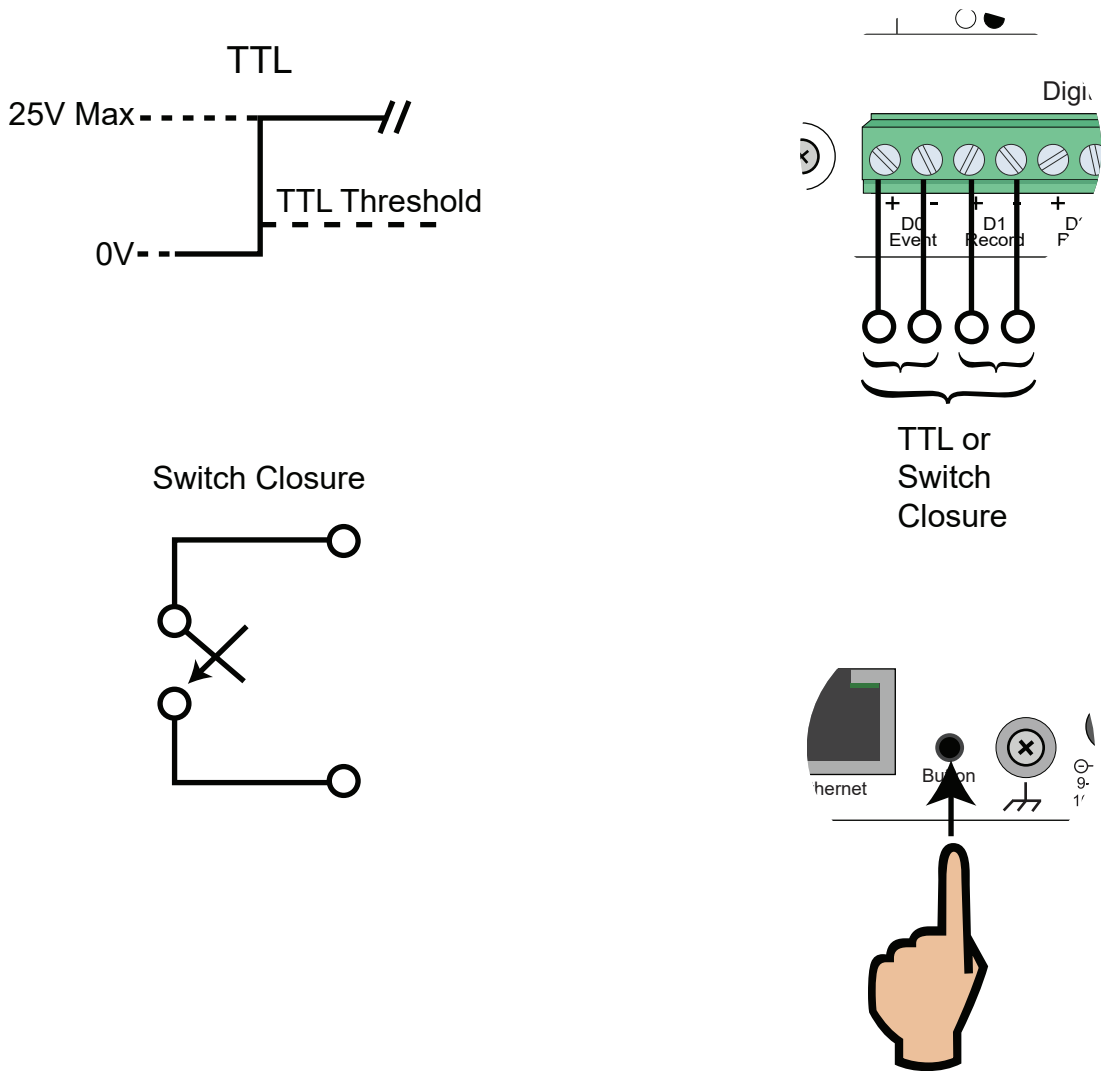

## Stand-alone Data Logger Operation

A USB drive can be used to record and store up to 32GB of data. The DI-4730 can record continuously using a circular buffer (with pre-defined trigger conditions) or record-until-full approach. A push button allows manual start/stop control over the recording process. A multi-color LED shows the status of the DI-4730 (Record, Standby, Busy, Error).

Varying degrees of flash memory technology will influence performance when recording in stand-alone mode. With a flash memory card incorporating SLC technology, throughput rates up to 160 kHz can be achieved. That rate drops to 50 kHz when using a pSLC card, and 10 kHz using a flash memory card incorporating MLC or some other branded technology.

Flash Technology	Speed
MLC/Generic	Up to 20 kHz
pSLC	Up to 50 kHz
SLC	>50 kHz

## Triggering with Stand-alone Operation

Set a trigger and the amount of pre and post trigger data scans to capture only the data you want.

With a trigger and number pre/post trigger scans selected, you can capture just the data you're interested in, before and after an event occurs. Choose a trigger level on any analog channel and acquire up to 2 G of pre and post trigger data to a USB drive. You can choose a trigger channel, trigger level and the number of pre and post trigger scans. The auto rearm option enables you to continuously create new files each time the threshold level is breached.

This is particularly useful in the case of a destructive test. For example, when ramping up current to a motor until a failure occurs, you're likely interested in how the motor behaved just prior to the failure, and what happened immediately thereafter. Was the failure gradual, or sudden? Were there indicators leading up to the failure? Triggered storage allows you to hone in on that information.

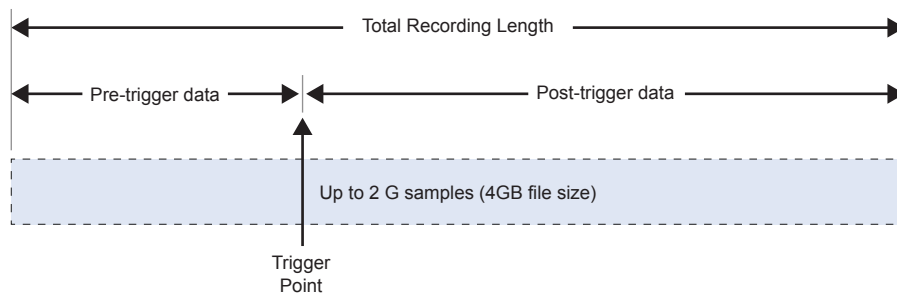

Specify the trigger channel, level, rising or falling slope.

### Rising Slope

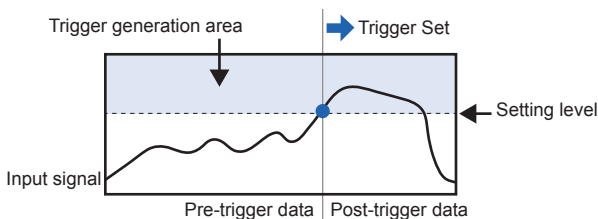

### Falling Slope

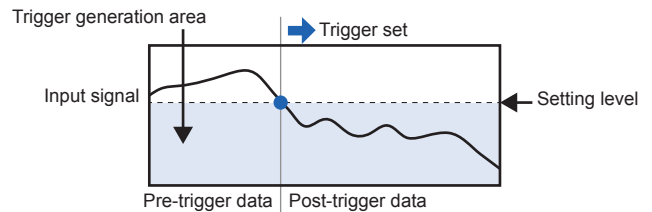

## Stand-alone Setup

The stand-alone configuration of the DI-4730 is performed using the WinDaq Dashboard. With the DI-4730 plugged into an available USB port or accessible Ethernet port, run the WinDaq Dashboard, select the device you would like to configure, and select “Stand Alone Setup” from the “Configure” menu. Configurable settings include:

- Enable analog channel and setup - including selection of gain (measurement range), reporting mode (average, last point, max, min), and user annotation.
- Enable digital channel for remote storage and events or general-purpose discrete inputs.
- File Storage mode including record on trigger conditions.
- Sample Rate selection as sampling interval.
- File Storage Format: WinDaq or CSV.
- Record on Power Startup option.
- Immediate Start Recording button for Ethernet-connected devices.
- Save Configuration and Load Configuration utility.

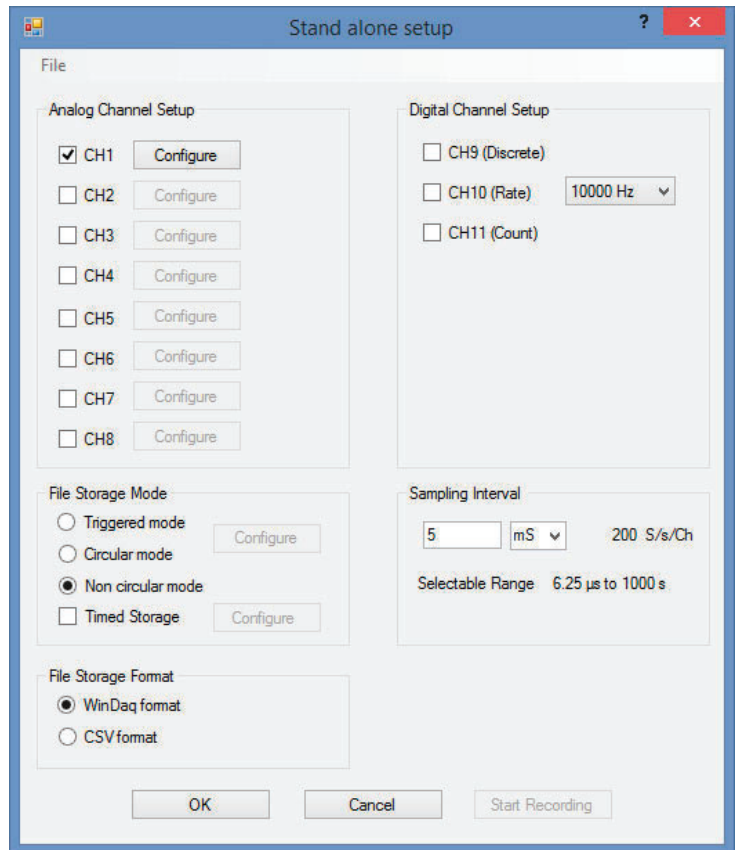

## Ethernet Settings

The network configuration (assigning an IP address, subnet mask, etc.) can be performed from the WinDaq Dashboard. This provides easier setup on any Local Area Network. Connect the DI-4730 device via the USB port, set the IP address of the device, and then deploy the device on your network.

Alternatively, a JSON file (the JSON file must be named network.json) can be used to load the network configuration. The JSON file can be created using any text or JSON editor, and then placed on a USB flash drive.

With the DI-4730 in Stand-alone/Ethernet mode, press down and hold the control button while inserting the USB drive. This will force the device to retrieve any available configuration files from the drive.

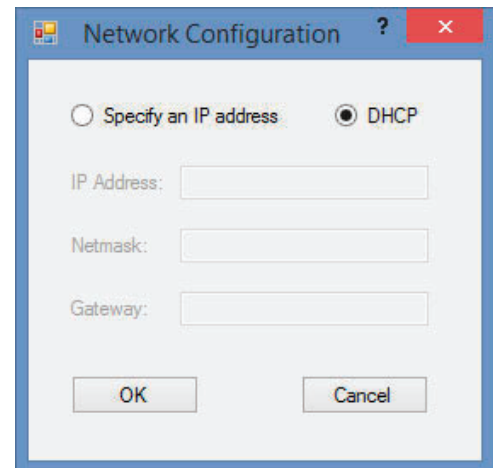

```
{
  "Network": {
    "IP": "192.168.0.196",
    "Netmask": "255.255.255.0",
    "Gateway": "192.168.0.1"
  }
}
```

## USB Synchronization

Add up to fifteen additional DI-4730, DI-4718B, DI-1120, DI-4108, and DI-4208 USB instruments for a total of 128 analog channels and 105 digital ports at a maximum throughput rate  $\geq 480$  kHz using ChannelStretch™ technology (see Specifications section for details). Multiple instruments connected to the same USB hub synchronize to within 10  $\mu$ S between units. Cascade multiple USB hubs to accommodate up to 16 total devices. Best of all, when using WinDaq software, the enabled channels of all synced devices record data to the same WinDaq application. All data is displayed and stored together as if they were a single instrument. The WinDaq/Pro Unlock option per device is required to synchronize when using WinDaq software.

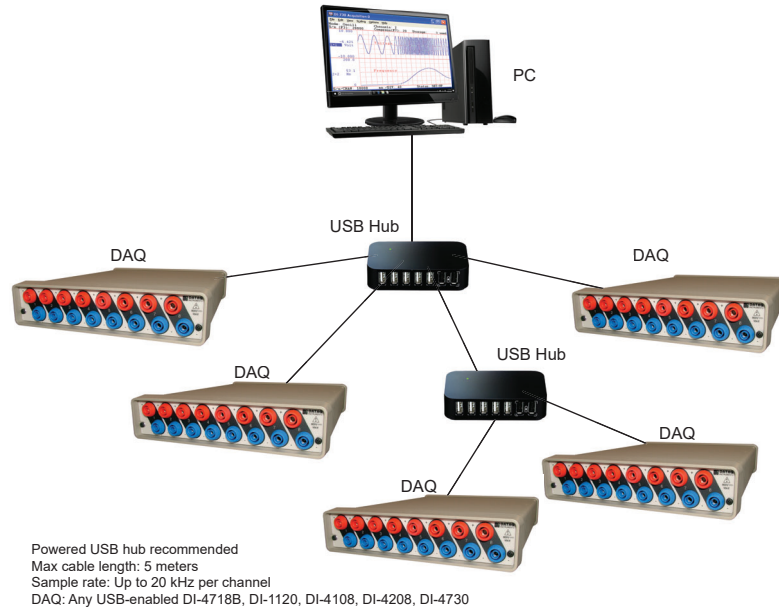

## Ethernet Synchronization

Add up to fifteen additional DI-4730, DI-4718B, DI-4108-E, or DI-4208-E instruments for a total of 128 analog channels and 105 digital ports at a maximum throughput rate  $\geq 50$  kHz using ChannelStretch™ technology (see Specifications section for details). Access the devices via LAN or WiFi. Multiple instruments connected to the same Ethernet switch automatically synchronize to within 200  $\mu$ S between units. Best of all, when using WinDaq software, data from the enabled channels of all synced units record data to the same WinDaq application. All data is displayed and stored together as though they were a single instrument. The WinDaq/Pro Unlock option is required on a per-unit basis in order to synchronize using WinDaq software. Use a Power over Ethernet (PoE) switch to save time and money by eliminating the cost and inconvenience of running power to the device.

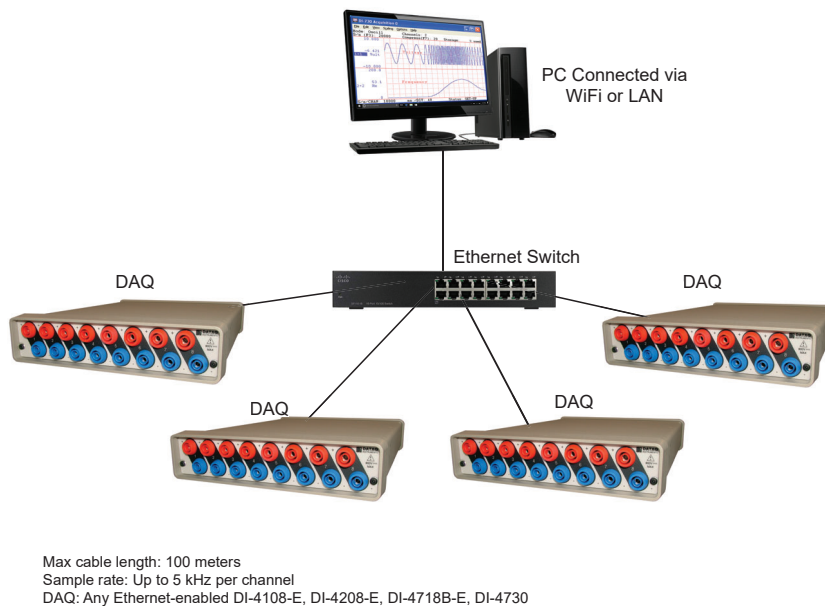

# Measure Anything

Measure virtually anything into a single file using ChannelStretch™ and the DI-4000 Series of products. Each product has its strengths that when combined can measure millivolts as small as  $\pm 10\text{mV}$ , volts as high as  $\pm 1000\text{V}$ , 4-20mA process current sensors, thermocouple temperatures, RTD temperatures, AC true rms voltages, strain gauge based sensors, frequencies, RPMs, events, resistance, potentiometers, and AC/DC voltage with excitation.

## DI-4108

8 differential analog inputs

Programmable ranges:  $\pm 200$ ,  $\pm 500$  mV,  $\pm 1$ ,  $\pm 2$ ,  $\pm 5$ ,  $\pm 10$  V full scale

7 bidirectional digital ports

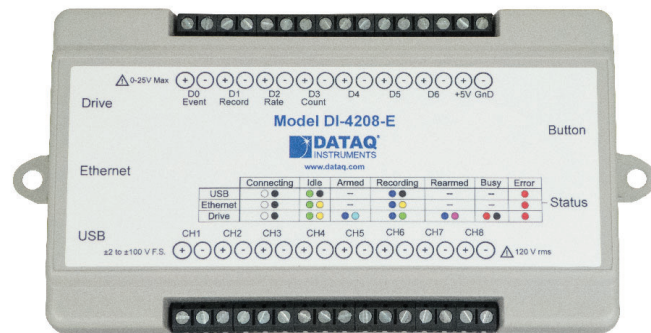
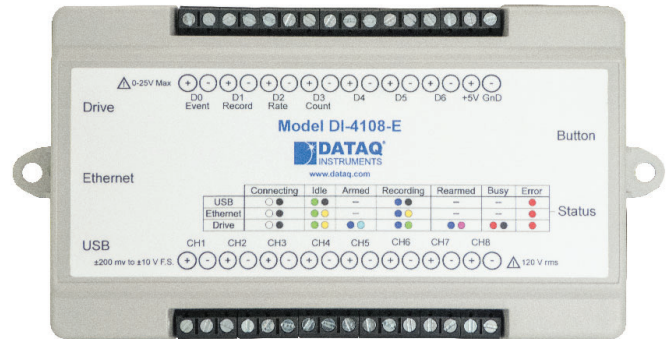

## DI-4208

8 differential analog inputs

Programmable ranges:  $\pm 2$ ,  $\pm 5$ ,  $\pm 10$ ,  $\pm 20$ ,  $\pm 50$ ,  $\pm 100$  V full scale

7 bidirectional digital ports

## DI-4718B

8 DI-8B-style inputs isolation provided by 8B modules

Programmable ranges: Dependant on DI-8B module

2 digital inputs



## DI-4730

8 differential isolated inputs

Programmable ranges:  $\pm 10\text{mV}$ ,  $\pm 100\text{mV}$ ,  $\pm 1\text{V}$ ,  $\pm 10\text{V}$ ,  $\pm 100\text{V}$ ,  $\pm 1000\text{V}$  full scale

7 digital inputs



# Measure Anything

Adding a DI-4718B product into your testing system expands your measurement capability with isolated signal conditioners for a multitude of applications including thermocouple, RTD, process current, force, pressure/vacuum, torque, RPM/speed, load, strain, distance, and more. View some of the applications below.

## AC or DC Current Shunt:

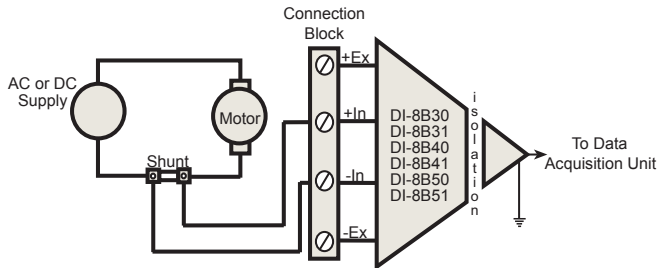

## Frequency:

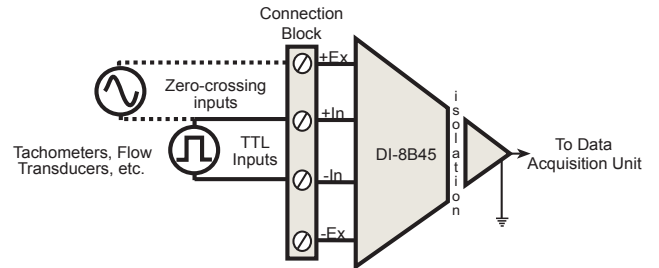

## Process Current:

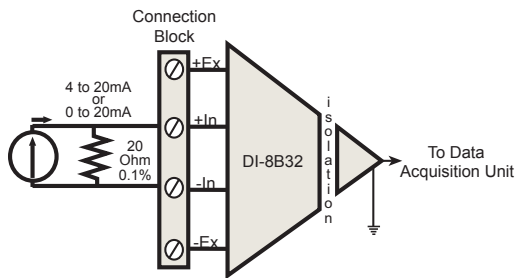

## Full-Bridge Strain Gage:

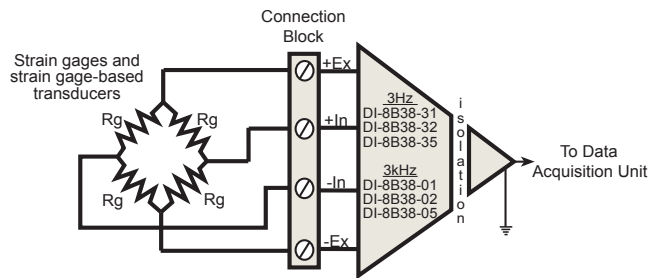

## True RMS:

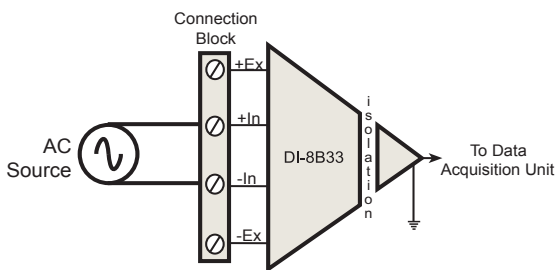

## DC Transducer:

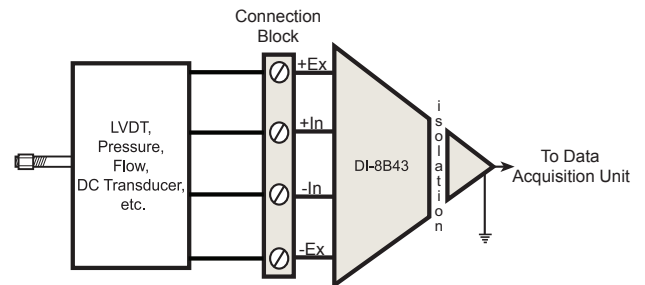

## Floating Grounded TC:

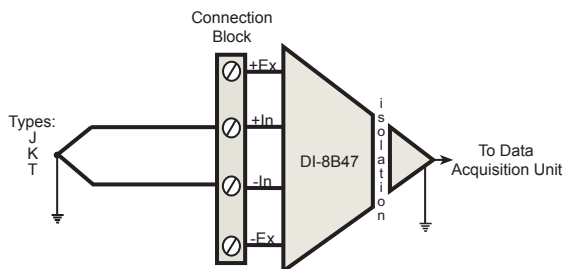

## RTD:

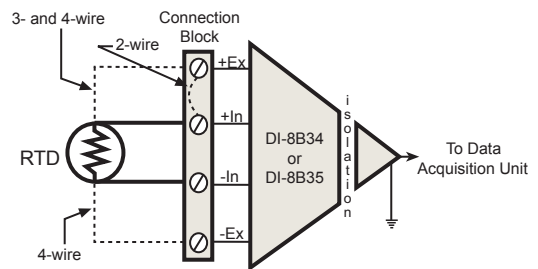

## Setup\*

Double-click and enter the channels you want to acquire into the WinDAQ scan list, even from multiple units with Channel-Stretch™. Click to select signal averaging, maximum, minimum, or last point operation per channel. Click to define a single to 8-channel display - either triggered sweep (oscilloscope-like) or scrolling (chart recorder-like). Click again to define a sample rate ranging from two samples per hour to 160 kHz throughput per device.

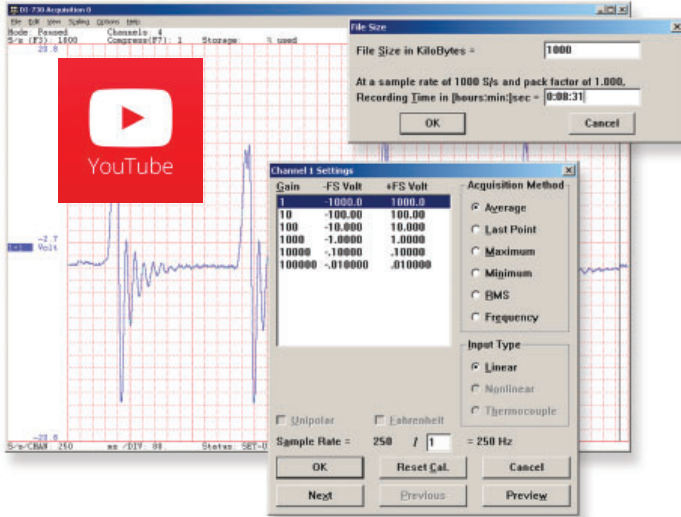

## Calibrate

Define calibration per channel to display waveform values in meaningful units such as psi, °F or °C, amps, rpm, watts, horsepower — any unit of measure you need.



## Record

Choose a continuous waveform recording mode or the triggered mode with selectable trigger level, slope, and post-trigger times. WINDAQ automatically time- and date-stamps, then streams acquired data to disk — record as much data as you need. At the same time, WINDAQ supplies a real-time graphical display of any or all channels so you always know where you are and where you're going.

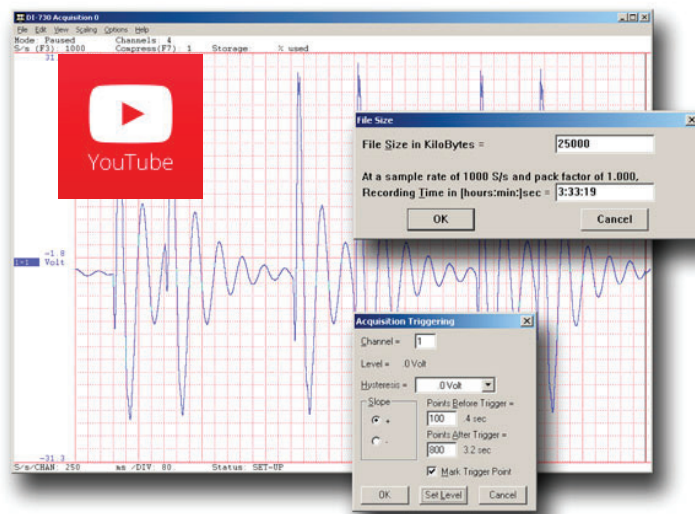

## Annotate

Of course, you can label any channel with text that describes it — “Motor 1,” “Engine speed,” “Vertical position,” etc. But WINDAQ also allows you to supply commented event markers while you record — “Beginning test phase 1,” “Small vibrations noticed,” “Starting cool-down cycle,” etc. Your comments and our acquired data combine to form a complete diary of your data acquisition session.

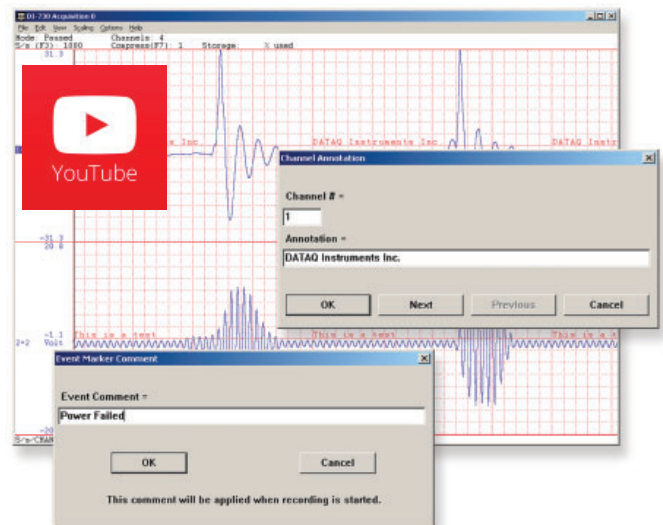

\* WinDAQ/Unlock required per device to use ChannelStretch™ and to record more than four total channels when using WinDAQ software.



## Playback

Recording is only half the solution. WINDAQ's Waveform Browser playback software allows you to graphically manipulate waveforms in ways you've never seen on a PC. Compress an entire recording to one screen-width for a bird's eye view, then expand around an area of interest for a closer look. Use the cursor to measure amplitudes and timing with precision. Move to any event marker with the click of a mouse button.



## Multitask

Double your productivity and let WINDAQ record while you review last week's results from your spreadsheet, or compose a memo with your word processor. You can even play back data already stored to disk while you're still recording.

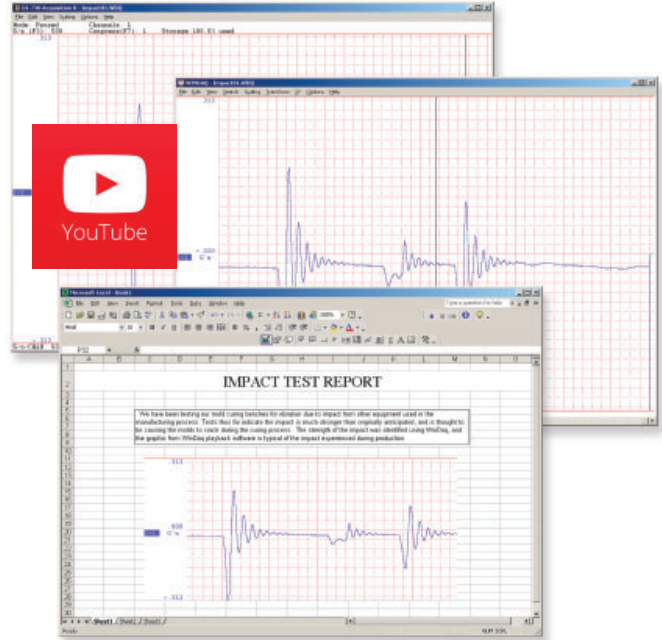

## Analyze

Waveform interpretation is easy with our built-in analysis functions. Apply frequency and filtering analysis with the WINDAQ Waveform Browser FFT and DFT functions. Analyze any range of waveform data with the statistics function. Use X-Y plotting to examine the relationship of one channel to another. Optional Advanced CODAS analysis functions allow waveform peak detection, integration, differentiation, arithmetic operations, and more.

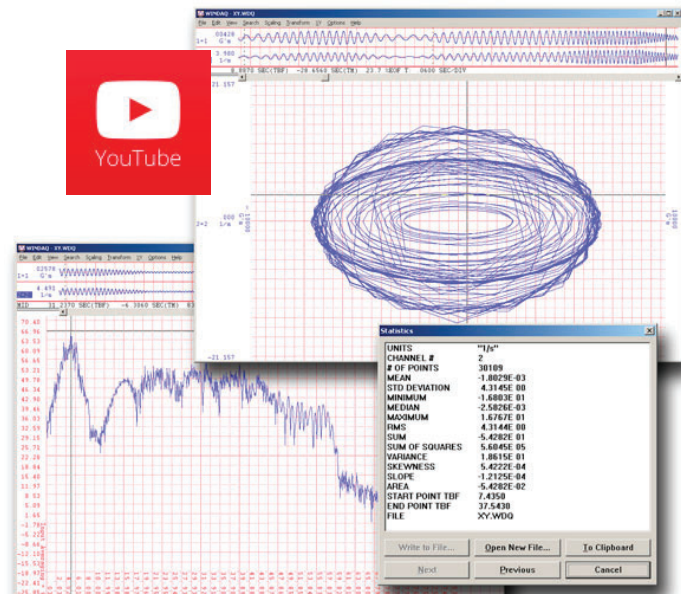

## Export

The WINDAQ Waveform Browser can export any range of data to your spreadsheet, or any other analysis or presentation package you use. You can even copy a graphical image displayed by the WINDAQ Waveform Browser and paste it directly into a word processing document. Finally, export any range of waveform graphics to your printer for a hard copy record.

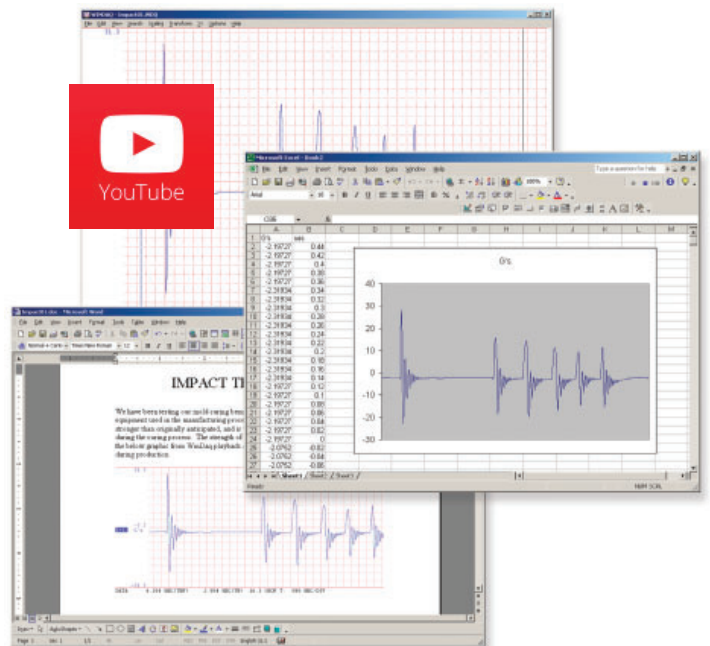

## Four Analog Channel Reporting Modes

The DI-4730 can be configured per channel to report just the last sample acquired like other data acquisition products. Unlike other products three additional reporting modes, selectable per analog channel, provide much more flexibility when reporting oversampled data:

### Anti-alias filter

Oversampled data is passed through the DI-4730's anti-alias CIC filter. Use this mode to dramatically reduce the unwanted effects of alias frequencies and noise.

### Maximum value

Oversampled data is evaluated for the maximum value. Use Maximum to peak-detect complex waveforms.

### Minimum value

Oversampled data is evaluated for the minimum value. Use Minimum to valley-detect complex waveforms.

All four operating modes are supported by WinDaq software. And, since they are applied by DI-4730 firmware, custom programs can easily leverage these features without incremental programming overhead.

## Published Protocol

Sometimes you can't use a ready-to-run application like WinDaq. You need to develop your own software to perform in precisely the way you need. That requirement defines the need for programming support so you have the tools necessary to move forward.

### Included Protocol Documentation

As you probably suspect when you run our point-and-click WinDaq data acquisition software, there's a lot going on beneath the surface. WinDaq software needs to take the data acquisition configuration that you design using its menu system and communicate that to the hardware. These are things such as sample rate, the number of channels enabled, the specific channel numbers enabled, etc. Diving down to the lowest level of program activity, past the WinDaq user interface, beyond the device driver to the actual commands sent to the data acquisition hardware and the format of the responses they evoke, is the protocol. The protocol defines the exact set of commands a program can send to the hardware, and how the hardware will react as a result. So, if you know the command and response definitions for the DI-4730 (i.e., its protocol), the instrument can be folded into virtually any operating system and any programming language: Python, C++, Linux, Windows, OSX, etc.



# DI-4730 Specifications

## Analog Inputs

Number of Channels:	8
Configuration:	Differential
Full Scale Range:	Programmable $\pm 10\text{mV}$ , $\pm 100\text{mV}$ , $\pm 1\text{V}$ , $\pm 10\text{V}$ , $\pm 100\text{V}$ , $\pm 1000\text{V}$
Isolation:	$\pm 1000\text{V}$ input-to-output and channel-to-channel
Max normal mode voltage ( $V_{\text{NM}}$ ):	800VDC or peak AC
Max common mode voltage ( $V_{\text{CM}}$ ):	1000VDC or peak AC
Max Input without Damage:	$\pm 1000\text{VDC}$ or Peak AC ( $\pm 1000\text{V}$ and $\pm 100\text{V}$ Ranges all other ranges with fuse protection)
Common Mode Rejection:	100dB min @ DC to 60Hz
Accuracy:	0.25% of full scale range $\pm 100\mu\text{V}$ N.A. for 10mV range
Input Impedance:	10M $\Omega$ for all ranges
Analog frequency response (each ch):	$\pm 1000$ , 100, 10, 1V: -3 db @ 5.0 kHz $\pm 100\text{mV}$ : -3 db @ 4.50 kHz
Channel-to-channel crosstalk rejection:	-75 dB @ 100kHz into 100 $\Omega$ unbalanced
Analog input connector type:	Safety banana socket - 1 pair per ch

## ADC Characteristics

Resolution:	12- to 16-bit Above zero ADC counts: 2,047 to 32,767 Below zero ADC counts: 2,048 to 32,768
Max. throughput sample rate:	Standard: 160 kHz Stand-alone: 20 kHz to 160 kHz (dependent on flash memory)
Min. throughput sample rate:	Standard: 20 Hz (2.2 samples per hour with WinDaq) Stand-alone: 0.0017 Hz
Sample rate timing accuracy:	100ppm

## Digital Inputs

Total port count:	7
Configuration:	Input
Threshold levels:	TTL compatible
Absolute maximum applied voltage:	25 V dc

## Reserved Digital Inputs

D0:	WinDaq remote events
D1:	WinDaq remote start/stop
D2:	Rate input
D3:	Count input

## Rate/Count Inputs

Internal pull-up value:	4.7 k $\Omega$
Input high voltage threshold:	2.4 V
Input low voltage threshold:	0.8 V
Terminal count:	65,535
Maximum rate frequency:	50 KHz with one enabled channel 20 KHz with 2-4 enabled channels 10 KHz with 5-7 enabled channels
Minimum rate frequency:	0.5 Hz
Maximum count frequency:	50 kHz

## Ethernet Interface

Type:	10/100Base-T
Connector:	RJ-45
Protocol:	TCP/IP
Server Type:	DHCP or Fixed IP

## Removable Memory

Type:	MLC, pSLC, or SLC flash memory (with USB SD card reader); USB thumb drive
Required Format:	FAT32

## Indicators and Connections

### Rear Panel

Button:	Multi-function control (Start, Stop, Save Configuration, Apply Configuration)
USB Drive (Type-A):	USB drive for stand-alone data logging
Status LED:	Single multi-color LED

	Connecting	Idle	Armed	Recording	Rearmed	Busy	Error
USB	○●	●●	—	●●	—	—	●●
Ethernet	○●	●●	—	●●	—	—	●●
Drive	○●	●●	●●	●●	●●	●●	●●

USB Connector:	USB 2.0 (mini-B style connector) PC communications
Ethernet Port:	RJ-45 10/100Base-T; PoE supported
Digital I/O connections:	One 16-position screw terminal block
Ground Lug:	Connect to Earth Ground
Power Adapter and Switch:	9-36 VDC

### Front Panel

Analog Input Connections:	16 insulated banana jacks (2 per channel)
---------------------------	-------------------------------------------

## ChannelStretch™ Operation

### USB

Total Max Units:	16
Max Channel Count:	128 Analog, 112 Digital
Max Throughput:	$\geq 480$ kHz
Channel skew between any 2 units:	10 $\mu\text{s}$ , typical
Synchronization Conditions:	Syncs with any combination of DI-4108, DI-4208, DI-4718B, and DI-4730 USB instruments. All synced instruments must operate at the same sample rate per channel, regardless of channel number, type, or range. All instruments must be connected to the same USB controller. The use of USB hubs are recommended to meet this requirement.

### Ethernet

Total Max Units:	16
Max Channel Count:	128 Analog, 112 Digital
Max Throughput:	$\geq 50$ kHz
Channel skew between any 2 units:	100 $\mu\text{s}$ , typical
Synchronization Conditions:	Syncs with any combination of DI-4108, DI-4208, DI-4718B, and DI-4730 Ethernet instruments. For most accurate synchronization, all instruments should be connected to the same Ethernet switch.

## Power

Power Consumption:	14 Watts
--------------------	----------

## Environmental

Operating Temperature:	0 to 50 °C (32°F to 122°F)
Operating Humidity:	0 to 90% RH non-condensing
Storage Temperature:	-20 to 60 °C (-4°F to 140°F)
Storage Humidity:	0 to 90% non-condensing

## Physical Characteristics

Enclosure:	Aluminum base with steel wrap-around
Mounting:	Desktop; bulkhead
Dimensions:	7.29"W $\times$ 9"L $\times$ 1.52"H (18.5D $\times$ 22.86W $\times$ 3.86H cm.)
Weight:	approx. 3 lbs

## Software Support

WINDAQ software:	OS support: View Online ( <a href="https://www.dataq.com/products/windaq/windows-compatibility/">https://www.dataq.com/products/windaq/windows-compatibility/</a> )
Programming:	Published instrument protocol

## Ordering Information

Description	Order No.
<b>DI-4730 Data Acquisition (DAQ) System</b> Includes instrument, 6-ft. USB cable, 5-foot Ethernet cable, AC power adapter, screwdriver, and USB flash drive with WinDaq software.	DI-4730
<b>WinDaq/Pro Unlock</b> Unlocks ChannelStretch™ to allow synchronized data acquisition and full stand-alone data logging capability where all channels can be recorded to the flash drive (without the Unlock Code only a single channel may be recorded to flash memory).	WinDaq/Pro DI-4730
<b>NIST-4730-CAL</b> Re-calibration Service, this calibration certificate is included with new instruments. NIST-traceable calibration certificate for all DI-4730 data acquisition and data logger products. Shipping charges do apply when ordering online.	NIST-4730-CAL
<b>101018</b> SPARE power supply for DI-4730 and DI-808 products.	101018
<b>SB-1</b> Pair (2) of stacking brackets with mounting screws for DI-720, DI-730, and DI-4730 products.	SB-1
<b>100690</b> One (1) stainless steel handle. Fits in stacking brackets to provide a handle for stacked units.	100690
<b>100730-1</b> Pair (2) of right-angle mounting brackets with mounting screws for DI-720, DI-730, and DI-4730 products.	100730-1
<b>MLC Flash Memory Card</b> Low-speed micro SD flash memory card. Recommended for recording rates under 20 kHz throughput.	2000351
<b>16GB pSLC Flash Memory Card</b> High-speed micro SD flash memory card. Recommended for recording rates from 20 kHz throughput to 50kHz.	101014-16-MS
<b>32GB pSLC Flash Memory Card</b> High-speed micro SD flash memory card. Recommended for recording rates from 20 kHz throughput to 50kHz.	101014-32-MS
<b>4GB SLC Flash Memory Card</b> High-speed micro SD flash memory card. Recommended for recording rates over 50 kHz throughput.	101014-4-HS
<b>8GB SLC Flash Memory Card</b> High-speed micro SD flash memory card. Recommended for recording rates over 50 kHz throughput.	101014-8-HS
<b>Flash Card Reader</b> Flash memory card reader for micro SD cards.	2000352



241 Springside Drive  
Akron, Ohio 44333  
Phone: 330-668-1444  
Fax: 330-666-5434

### Data Acquisition Product Links

(click on text to jump to page)

[Data Acquisition](#) | [Data Logger](#)