

DI-2108 USB Data Acquisition (DAQ) System

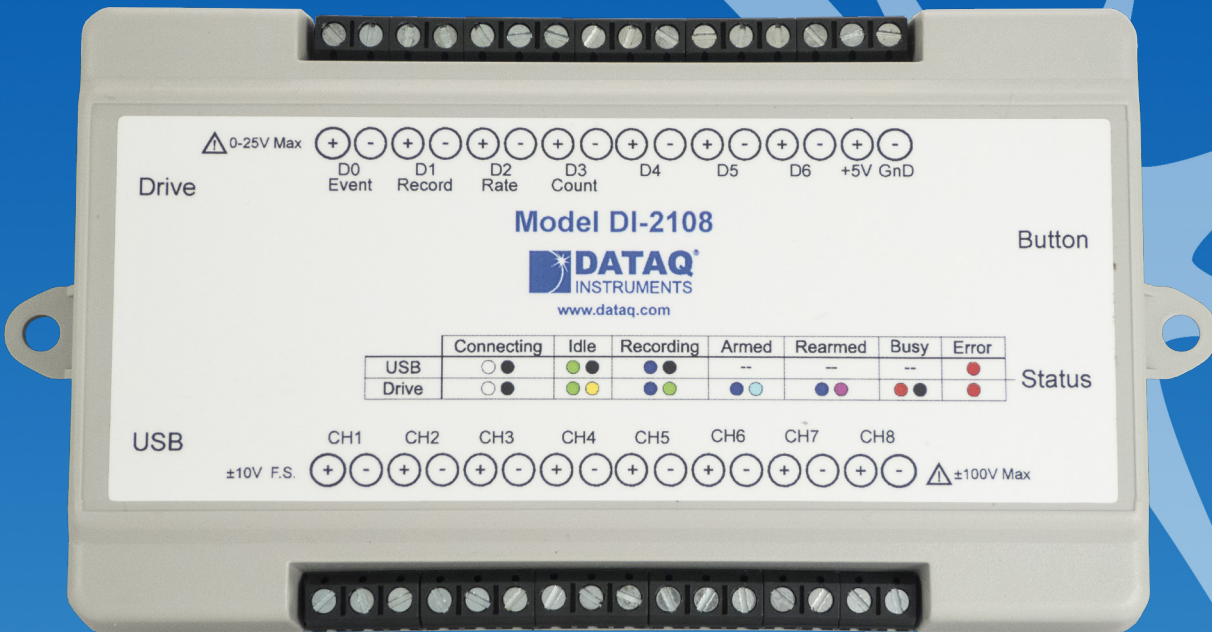

- ✓ Eight armored analog differential inputs
 - ✓ Up to ± 50 V without damage
 - ✓ 80 dB common mode rejection
 - ✓ Fixed measurement range of ± 10 V full scale
- ✓ PC-connected or stand-alone operation to USB flash drive
- ✓ Adaptable anti-alias filter per channel
 - ✓ Corner frequency set as a function of sampling rate
- ✓ Up to 16-bit analog-to-digital resolution
- ✓ Up to 220 kHz sample throughput rate
- ✓ Seven digital ports
 - ✓ Programmable per port as input or switch
 - ✓ Support for rate measurements to 50 kHz
 - ✓ Support for 16-bit counter
 - ✓ External trigger input
- ✓ Software support includes:
 - ✓ Ready-to-run WinDaq software
 - ✓ Published protocol for software development in all operating systems

DI-2108 Description

Analog Subsystem

Model DI-2108 delivers premium analog performance at a surprisingly affordable price. Eight analog input channels provide differential measurement flexibility and a ± 10 V full scale range. The differential input configuration provides noise rejection, easily adapts to single-ended signal sources, and is protected up to ± 50 V dc or peak ac so that inevitable measurement mishaps will not harm the instrument. The front-end feeds a flexible resolution analog-to-digital converter that ranges from 12 to 16 bits as a function of sampling rate. Lower sampling rates deliver higher resolution readings. The maximum sampling throughput rate of the DI-2108 is 220 kHz, providing 12 bits of resolution. Rounding off the analog subsystem are anti-alias filters per channel with automatic selection of corner frequency at approximately one tenth of the sampling frequency.

Digital Port Subsystem

The DI-2108 provides 7 digital ports, each configurable as an input or a switch. Input protection is provided to 25 V. When activated as inputs two ports allow dual functionality as discrete inputs, or programmed as a counter or rate input. The rate input features a 50 kHz maximum measurement allocated over twelve programmable measurement ranges (10 Hz to 50 kHz full scale.) The counter input provides 16-bit resolution and a terminal count value of 65,535. The discrete, counter, and rate inputs are members of the same internal scan list used by the analog input channels. This means that all enabled elements are acquired synchronously, which allows meaningful comparisons between analog and digital channels. For example, the rate input measuring engine speed allows rpm data to be acquired in lock-step with analog data. Configured as a switch a digital port can be used to control external loads up to 25 V @ 100 mA, and the switch can be controlled asynchronously without interfering with the scanning process.

Stand-alone Operation

A USB drive is used to record data in stand-alone mode. The DI-2108 can record continuously using a circular buffer with pre-defined trigger conditions or a record-until-full approach supporting remote start/stop. A push button allows manual start/stop control over the recording process. With a flash memory card incorporating SLC technology, throughput rates up to 160 kHz can be achieved. That rate drops to 50 kHz when using pSLC card, and 20 kHz using a flash memory card incorporating MLC. The included WinDAQ data acquisition software makes configuring the DI-2108 for stand-alone operation quick and intuitive. Use WinDAQ to set up channels and create a reference file. That reference file can then be copied to the USB drive and used for quick setup.

DI-2108 Close-up

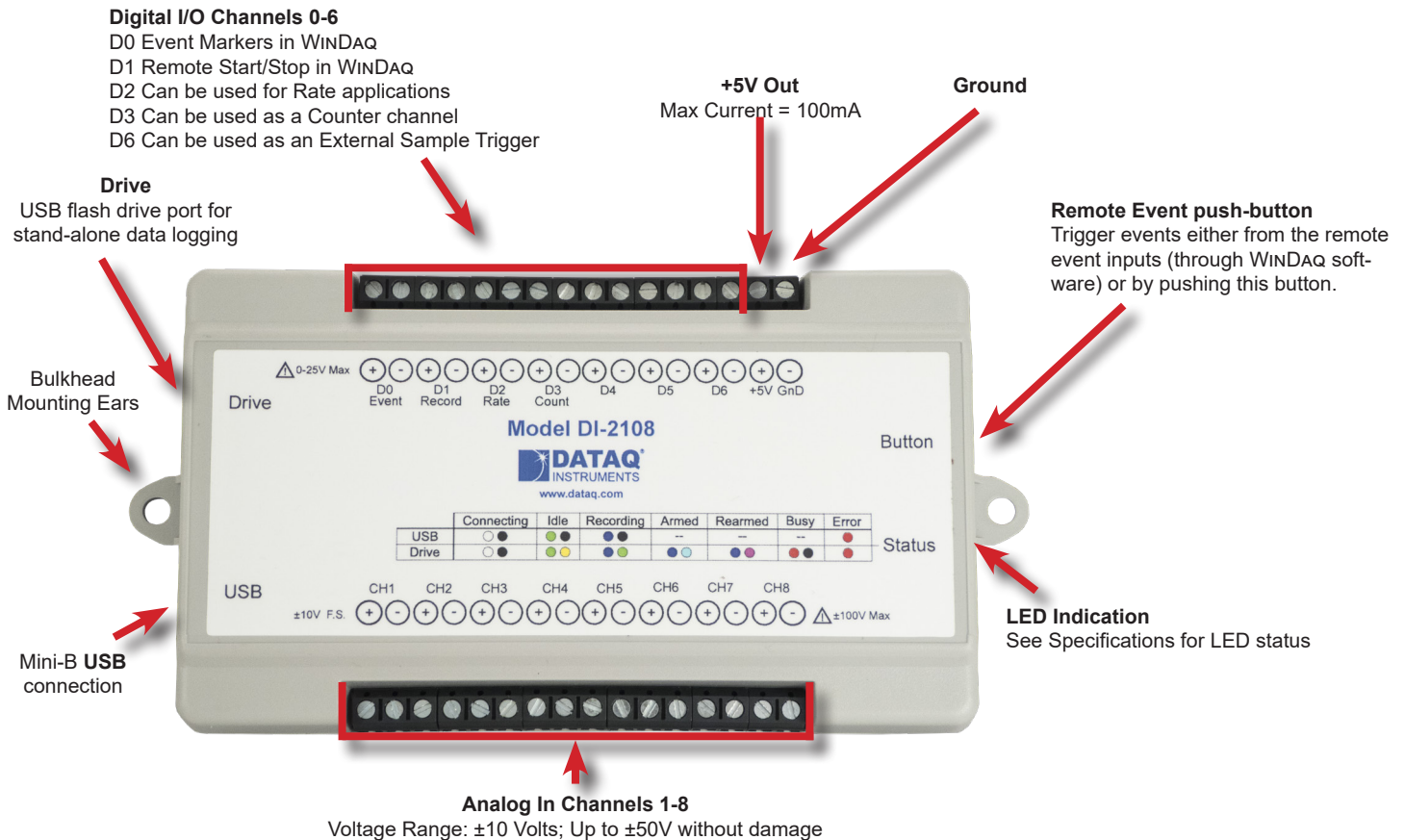

DI-2108 Major Features and Benefits

Eight Analog Input Channels

Measure as many as eight system variables at once with a fixed ± 10 V full scale range.

Differential Analog Input Configuration

Enhanced noise immunity.

Anti-alias Filter per Analog Channel

Reduces the risk of acquiring meaningless, aliased data. Corner frequency automatically selected at one-tenth of the sampling rate.

Armored Inputs Absorb Mistakes

Analog inputs are protected to ± 50 V and digital inputs up to 25 V.

Fast, 220 kHz Sample Throughput Rate

Observe fast phenomena that other products in the DI-2108 price range would miss.

Stand-alone Data Logger Operation

Store data to flash drives at throughput rates up to 160kHz.

12- to 16-bit ADC Resolution

One product potentially addresses your measurement needs, from low to high resolution, as a function of sampling rate.

Seven Digital Ports

Folds discrete I/O into the measurements process. Each bit is programmable as an input or as a switch.

Rate Measurement Channel

Measures pulse rate as may be acquired from a pickup for rpm measurement, or sensor to measure flow.

Counter Channel

Tallies the number of pulses applied. Useful for integrating rate information, like flow rate to volume, or simply the number of definable events.

Pre/Post Trigger Storage to USB Memory

Set trigger levels to record up to 2G (combined) of pre- and post-trigger data (total file size of 4G).

Software Support

Offered with ready-to-run WinDaq software and documented command protocol for OS-independent use.

DI-2108 Dimensional Drawing

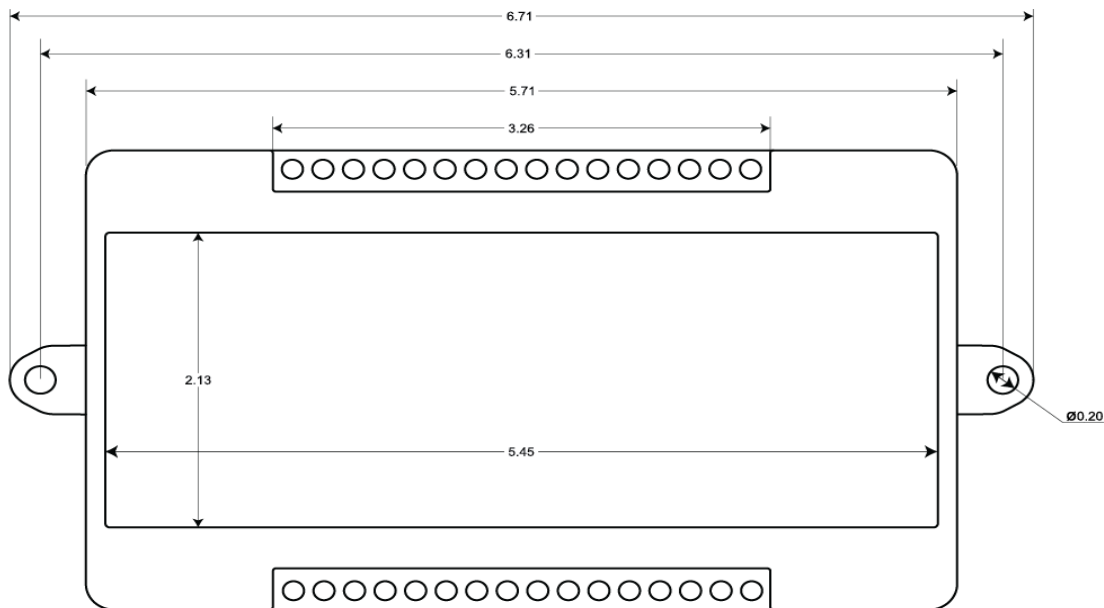

Top View

Side View

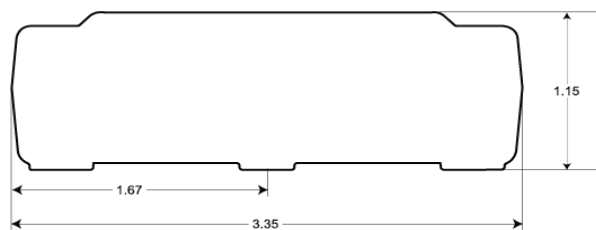

All dimensions in inches

Analog Input

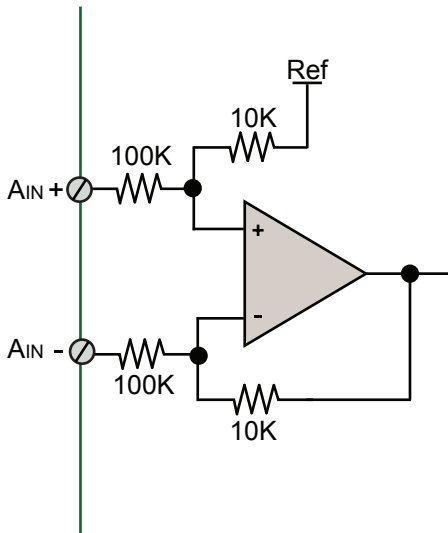

Digital Port

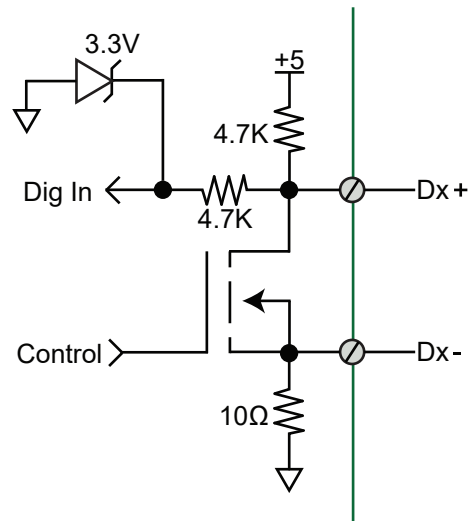

Anti-alias Filter Architecture

The DI-2108 employs an anti-alias filter per analog channel with automatic corner frequency selection. The filter is a CIC (cascaded integrator comb) type that uses as many as 512 samples per channel to calculate in real time as data is acquired. Filter response is optimized when sampling frequency is set to ten times the highest frequency of interest.

Typical Anti-alias Filter Frequency Response

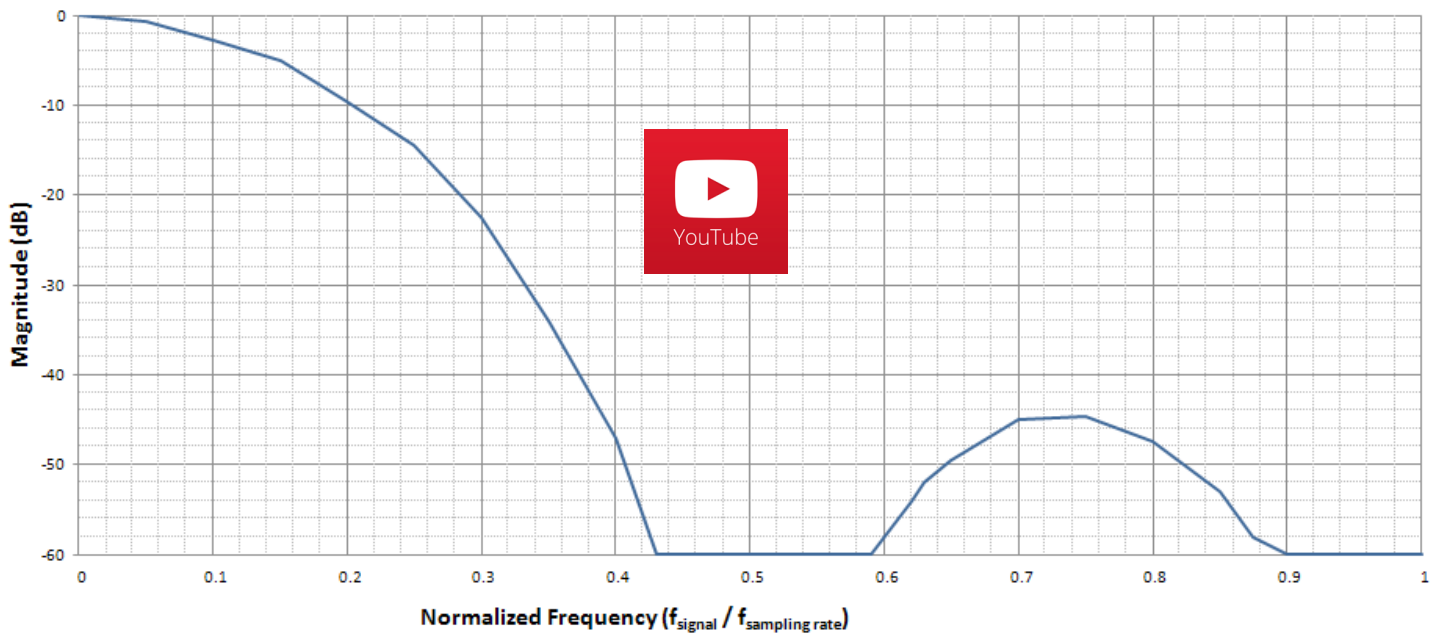

Analog-to-digital Converter Characteristics

DI-2108 ADC resolution is a function of sampling rate: Slower sampling rates yield higher resolution measurements. The DI-2108 achieves this using its real time CIC decimation filter to improve signal-to-noise ratio and to increase measurement resolution. Before the DI-2108 such techniques were reserved only for high-end instrumentation due to the cost of the processing power required to provide meaningful, multi-channel results in real time. But that cost has been driven down dramatically so that the 120 MIPS processor embedded in the DI-2108 is both affordable and more than adequate for the task.

The ADC bit resolution referred to here is bipolar. For example, 14 bits of measurement resolution provides a total of 16,384 ADC counts applied across the entire ± 10 V range per analog channel.

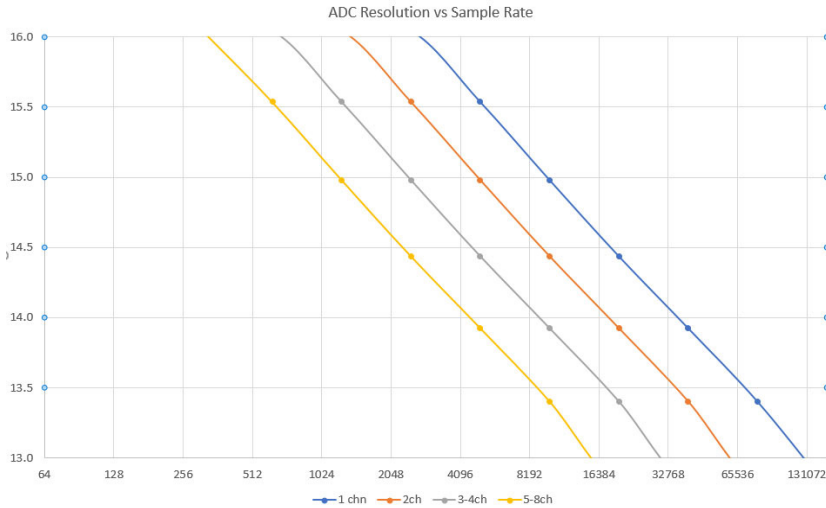

ADC resolution (R) is a function of selected sample rate per channel (F), and the number of enabled analog channels (C):

$$R = \frac{\log\left(\frac{160000}{FC}\right)}{\log(4)} + 12$$

Where:

C	Enabled Channels
1	1
2	2
4	3-4
8	5-8

Try out the online calculator at <http://www.dataq.com/products/di-2108/resolution.html> to determine the resolution.

DI-2108 Scan List Flexibility

The DI-2108 maintains an internal scan list of as many as eleven different items at once. The maximum sample throughput rate is 220 kHz, 20 kHz per scan list element with all positions enabled. Analog channels support a maximum sample throughput rate of 160 kHz, one analog channel at 160 kHz, two analog channels 80 kHz per channel, etc. The scan list can be populated with any combination of analog input channels, digital input ports, the rate channel, and the counter channel.

Item	Scan List Positions	Comments
Analog channels	Up to eight	One scan list position is consumed for each enabled analog channel
Digital inputs	One	All seven digital ports are read simultaneously with one entry in the scan list
Rate channel	One	
Counter channel	One	

DI-2108 Analog Measurements

Eight analog input channels with a fixed measurement range of ± 10 V full scale are supported by the DI-2108. Each offers differential input capability with rejection of common mode voltages (those that appear simultaneously and in-phase on both inputs.) These channels are also hardened to tolerate excessive voltages to protect against wiring mishaps (see specifications.)

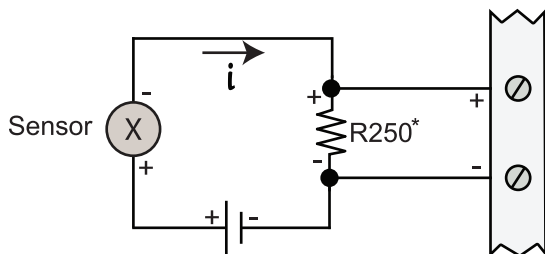

*Optional (see ordering guide)

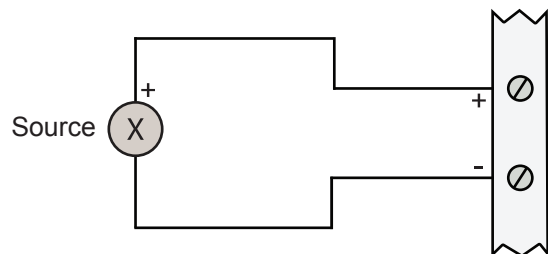

DI-2108 Rate and Count Measurements

Digital ports D2 and D3 can be programmed for multiple functions. Both can be programmed as discrete input or outputs. In addition, port D2 as a rate input and port D3 as a counter input. When either is programmed to measure rate and/or count the DI-2108 adds these measurements to its internal scan list along with any other analog and other digital data so that all measurements are acquired in the same time frame. Rate measurements in the range of 10 Hz to 50 kHz are possible across twelve programmable full scale ranges. Use the rate input to extract rpm data from a rotating device, or to acquire flow information from a pulse-type flow sensor. Count measurements up to 65,536 are supported by the D3 port. Use count to integrate flow to get volume, or use it simply to tally events in a given process.

Rpm from rate

The DI-2108's Rate input is used to acquire a frequency representing rpm, flow, or any other pulse stream.

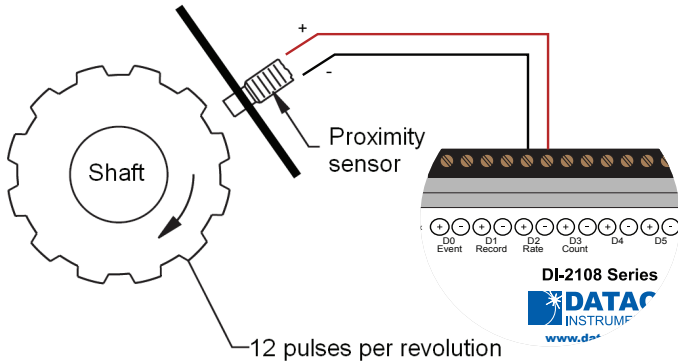

Flow/volume

Use the DI-2108's Count input to accumulate a tally of applied discrete pulses to track test cycles, extract volume from flow, or any other general-purpose totalizing application.

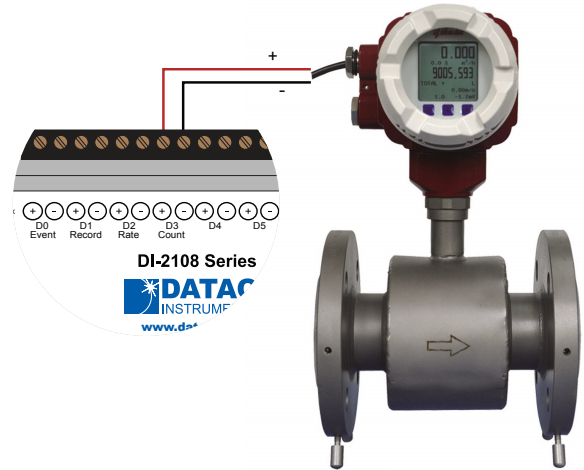

General-purpose Digital Port Operation

Each DI-2108 digital port can be configured as a digital input or used as a switch to control an external load. Ports are configured by a MOSFET that defines the port's function, where the MOSFET is either on or off. When the MOSFET is off the port is available as a discrete input. Turning the MOSFET on allows the port to function like a switch for loads up to 20 V and 100 mA. Care should be exercised when configuring the load to be switched to ensure that the digital port is not damaged:

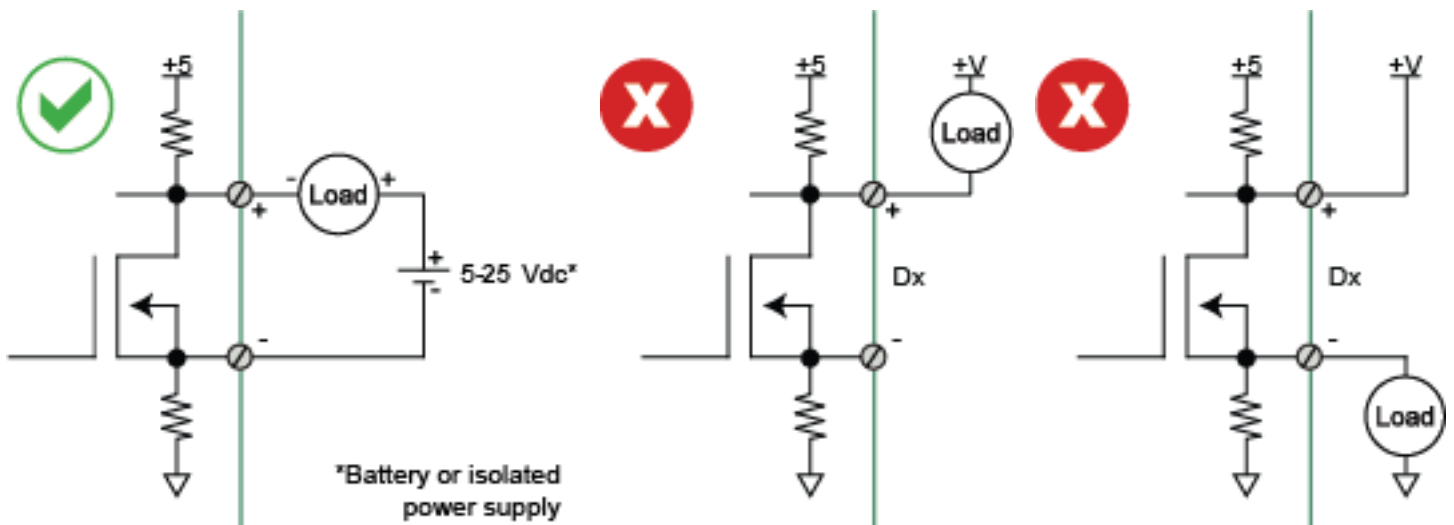

Stand-alone Data Logger Operation

A USB drive can be used to record and store up to 32GB of data. The DI-2108 can record continuously using a circular buffer (with pre-defined trigger conditions) or record-until-full approach. A push button allows manual start/stop control over the recording process. A multi-color LED shows the status of the DI-2108 (Record, Standby, Busy, Error).

Varying degrees of flash memory technology will influence performance when recording in stand-alone mode. With a flash memory card incorporating SLC technology, throughput rates up to 160 kHz can be achieved. That rate drops to 50 kHz when using a pSLC card, and 10 kHz using a flash memory card incorporating MLC or some other branded technology.

Please Note: The DI-2108 cannot be connected to your computer's USB port when recording to the USB thumb drive.

Flash Technology	Speed
MLC/Generic	Up to 20 kHz
pSLC	Up to 50 kHz
SLC	>50 kHz

Triggering with Stand-alone Operation

Set a trigger and the amount of pre and post trigger data scans to capture only the data you want.

With a trigger and number pre/post trigger scans selected, you can capture just the data you're interested in, before and after an event occurs. Choose a trigger level on any analog channel and acquire up to 2 G of pre and post trigger data to a USB drive. You can choose a trigger channel, trigger level and the number of pre and post trigger scans. The auto rearm option enables you to continuously create new files each time the threshold level is breached.

This is particularly useful in the case of a destructive test. For example, when ramping up current to a motor until a failure occurs, you're likely interested in how the motor behaved just prior to the failure, and what happened immediately thereafter. Was the failure gradual, or sudden? Were there indicators leading up to the failure? Triggered storage allows you to hone in on that information.

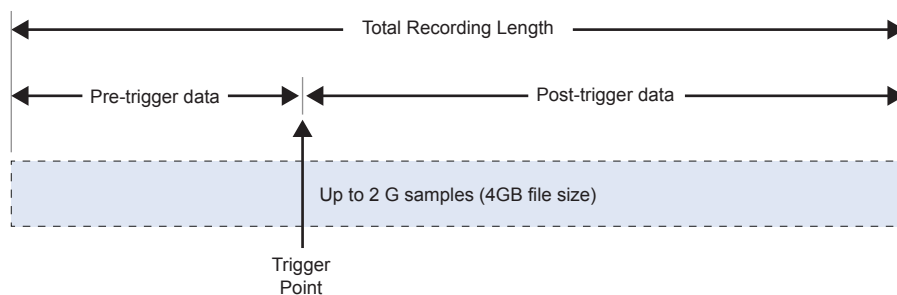

Specify the trigger channel, level, rising or falling slope.

Rising Slope

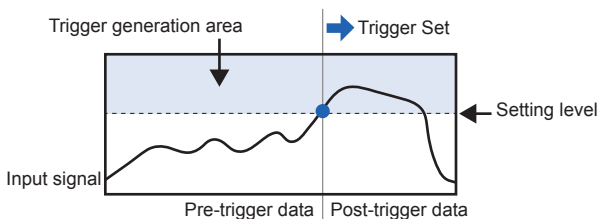

Falling Slope

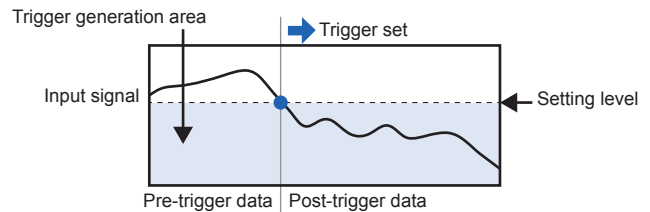

Stand-alone Setup

The stand-alone configuration for the DI-2108 is performed using the WinDaq Dashboard. With the DI-2108 plugged into an available USB port, run the WinDaq Dashboard, select the device you would like to configure, and select “Stand Alone Setup” from the “Configure” menu. Configurable settings include:

- Enable analog channel and setup
- Enable digital channels.
- File Storage mode including record on trigger conditions.
- Sample Rate selection as sampling interval.
- File Storage Format: WinDaq or CSV.
- Record on Power Startup option.
- Save Configuration and Load Configuration utility.

The screenshot shows the "Stand alone setup" dialog box. It features a "File" menu at the top left. The main area is divided into several sections:

- Analog Channel Setup:** A list of channels from CH1 to CH8. CH1 is checked, and each channel has a "Configure" button next to it.
- Digital Channel Setup:** A list of digital channels: CH9 (Discrete), CH10 (Rate) set to 10000 Hz, and CH11 (Count). Each has a checkbox and a "Configure" button.
- File Storage Mode:** Radio buttons for "Triggered mode", "Circular mode", "Non circular mode" (which is selected), and "Timed Storage". Each mode has a "Configure" button.
- File Storage Format:** Radio buttons for "WinDaq format" (selected) and "CSV format".
- Sampling Interval:** A text box with "5", a dropdown menu with "mS", and a rate of "200 S/s/Ch". Below it, it says "Selectable Range 6.25 μ s to 1000 s".
- Record on Power Startup:** A checkbox that is currently unchecked.

At the bottom of the dialog are three buttons: "OK", "Cancel", and "Start Recording".

Setup

Double-click and enter the channels you want to acquire into the WinDac scan list. Click to select an analog, rate, or count channel. Click to define a single to 8-channel display — either triggered sweep (oscilloscope-like) or scrolling (chart recorder-like). Click again to define a sample rate ranging from 18 samples per minute to 160,000 samples per second.

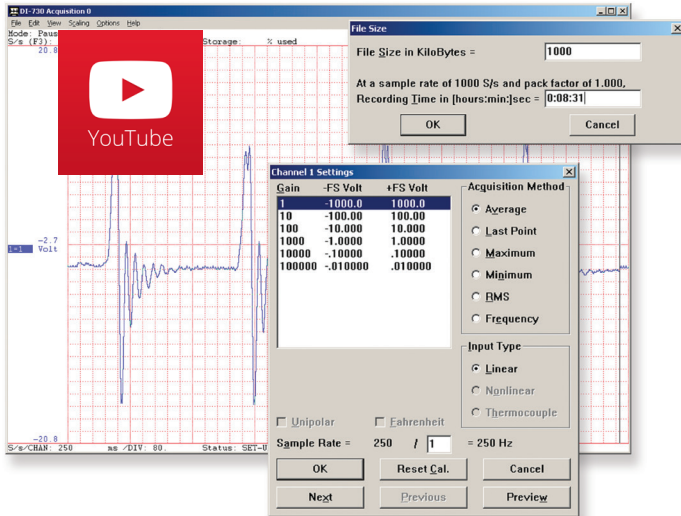

Scale

Define engineering units per channel to display waveform values in meaningful units such as psi, °F or °C, amps, rpm, watts, Horsepower— any unit of measure you need.

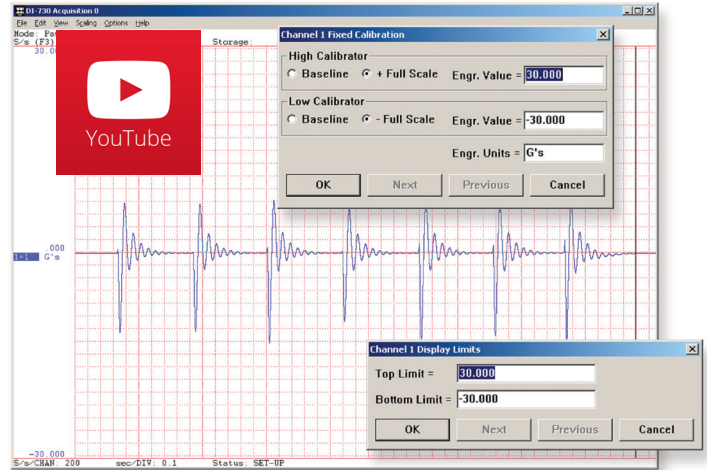

Record

Choose a continuous waveform recording mode or the triggered mode with selectable trigger level, slope, and post-trigger times. WINDAQ automatically time- and date-stamps, then streams acquired data to disk — record as much data as you need. At the same time, WINDAQ supplies a real-time graphical display of any or all channels so you always know where you are and where you're going.

Annotate

Of course, you can label any channel with text that describes it — “Motor 1,” “Engine speed,” “Vertical position,” etc. But WINDAQ also allows you to supply commented event markers while you record — “Beginning test phase 1,” “Small vibrations noticed,” “Starting cool-down cycle,” etc. Your comments and our acquired data combine to form a complete diary of your data acquisition session.

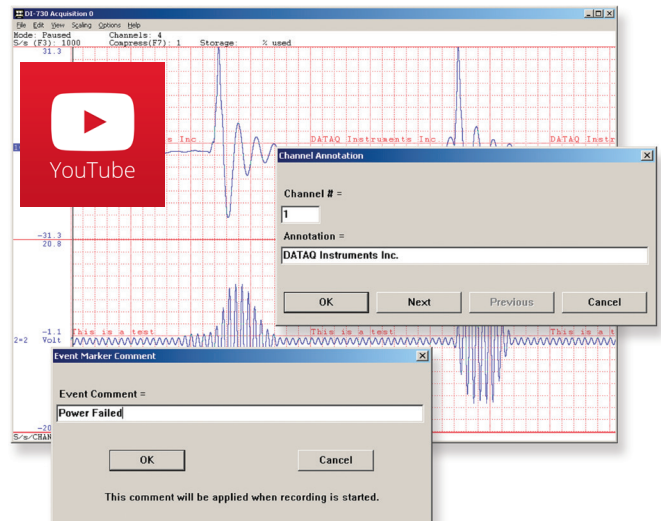
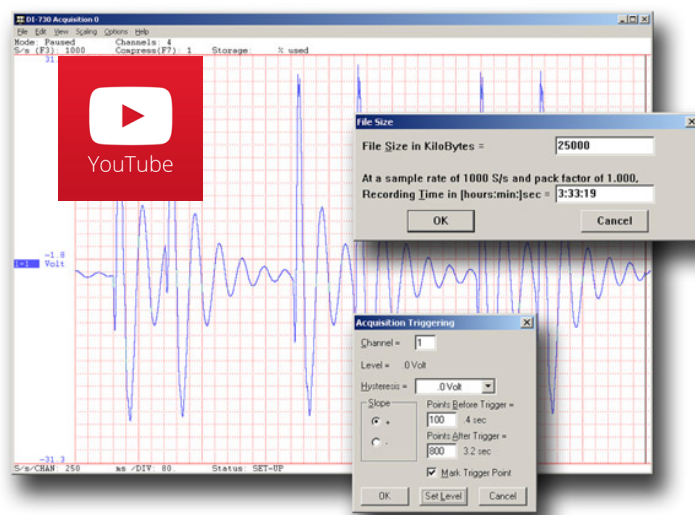

Playback

Recording is only half the solution. WINDAQ's Waveform Browser playback software allows you to graphically manipulate waveforms in ways you've never seen on a PC. Compress an entire recording to one screen-width for a bird's eye view, then expand around an area of interest for a closer look. Use the cursor to measure amplitudes and timing with precision. Move to any event marker with the click of a mouse button.



Multitask

Double your productivity and let WINDAQ record while you review last week's results from your spreadsheet, or compose a memo with your word processor. You can even play back data already stored to disk while you're still recording.

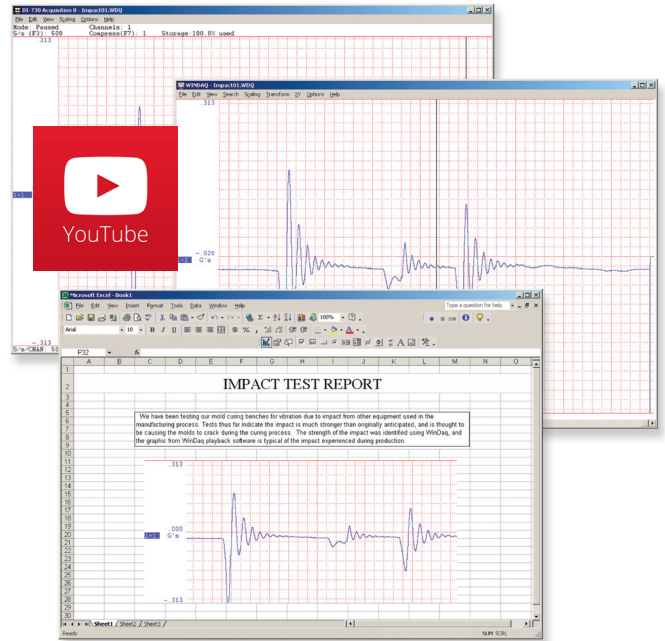

Analyze

Waveform interpretation is easy with our built-in analysis functions. Apply frequency and filtering analysis with the WINDAQ Waveform Browser FFT and DFT functions. Analyze any range of waveform data with the statistics function. Use X-Y plotting to examine the relationship of one channel to another. Optional Advanced CODAS analysis functions allow waveform peak detection, integration, differentiation, arithmetic operations, and more.

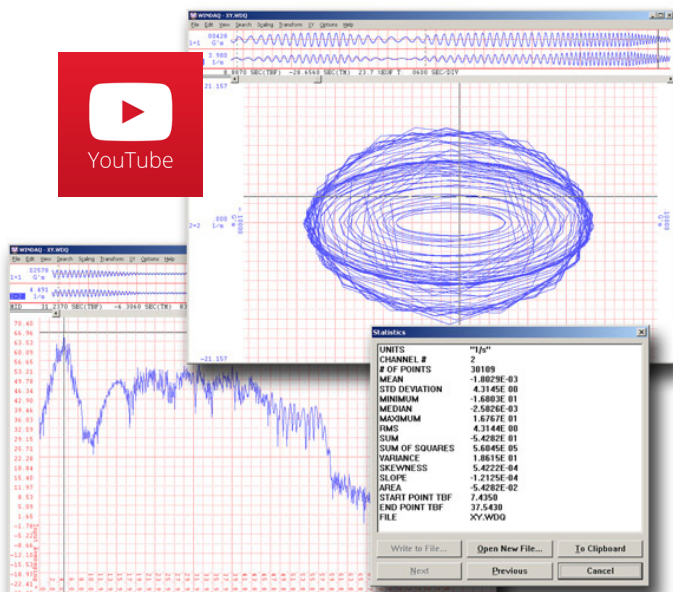

Export

The WINDAQ Waveform Browser can export any range of data to your spreadsheet, or any other analysis or presentation package you use. You can even copy a graphical image displayed by the WINDAQ Waveform Browser and paste it directly into a word processing document. Finally, export any range of waveform graphics to your printer for a hard copy record.

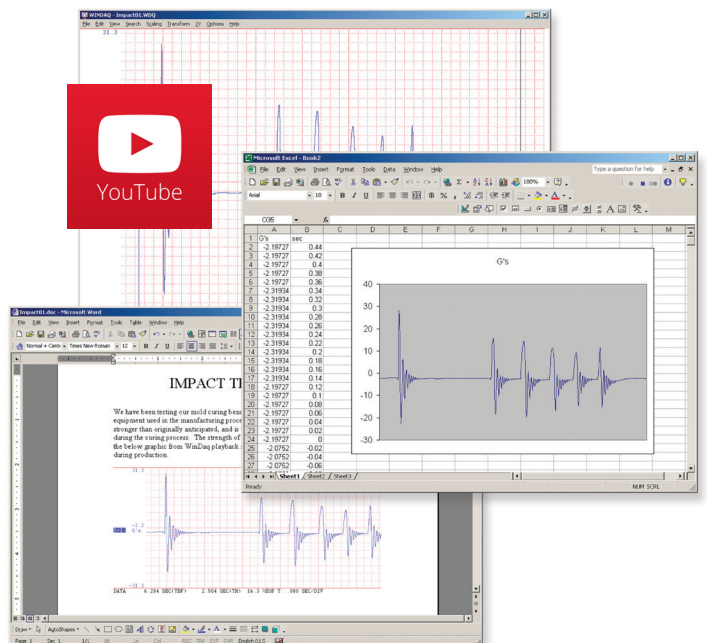

Four Analog Channel Reporting Modes

The DI-2108 can be configured per channel to report just the last sample acquired like other data acquisition products. Unlike other products three additional reporting modes, selectable per analog channel, provide much more flexibility when reporting oversampled data:

- **Anti-alias filter**
Oversampled data is passed through the DI-2108's anti-alias CIC filter. Use this mode to dramatically reduce the unwanted effects of alias frequencies.
- **Maximum value**
Oversampled data is evaluated for the maximum value. Use Maximum to peak-detect complex waveforms.
- **Minimum value**
Oversampled data is evaluated for the minimum value. Use Minimum to valley-detect complex waveforms.

All four operating modes are supported by WinDaq software. And, since they are applied by DI-2108 firmware, custom programs can easily leverage these features without incremental programming overhead.

Published Protocol and .NET Class

For programmers, the DI-2108 is supported outside of the supplied ready-to-run WinDaq application by a published protocol and a .NET class. The protocol defines the nuts-and-bolts communication syntax to and from the instrument that's necessary to configure the DI-2108, allow it to take measurements, and to retrieve those measurements through a connected PC. You'd use the DI-2108 at its protocol level if you wanted to program the instrument outside the Windows environment, and/or use a programming language that is not supported by .NET. For example, operating systems such as OSX and Linux, and programming languages such as Java and Python are candidate situations to use the DI-2108 Protocol. Otherwise, programming efforts using a .NET language such as Visual BASIC and C# under Windows take advantage of the .NET class provided with the instrument.

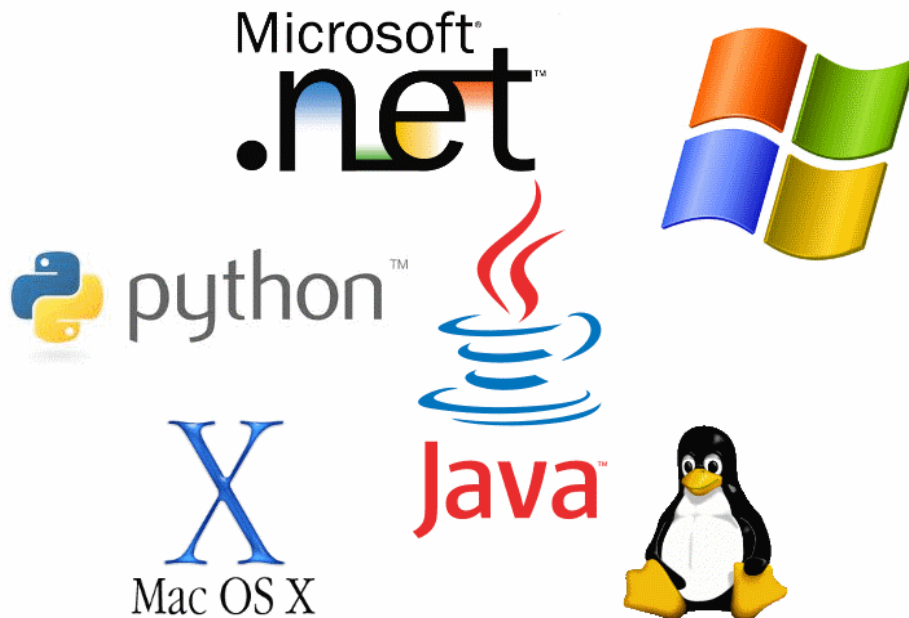

Signal I/O

Analog Inputs

Number of Channels:	8
Configuration:	Differential
Measurement range per channel:	±10 V full scale fixed
Input impedance:	110kΩ
Accuracy:	0.25% of full scale range 25°C, excluding common mode error
Absolute maximum input without damage:	±50 V dc or peak ac (normal mode + common mode)
Common mode range:	±20 V dc or peak ac
Common mode rejection ratio:	80 dB (dc - 60 Hz)
Channel-to-channel crosstalk rejection:	-80 dB

Digital Ports

Number of ports:	7
Type:	MOSFET switch
Configuration:	Programmable as digital input or switch
Pull-up value:	4.7 kΩ
Input high voltage threshold:	2.4V
Input low voltage threshold:	0.8V
Absolute maximum applied voltage (V):	0 ≤ V ≤ 25 V

Reserved Digital Inputs

Port 1:	WinDaq remote events
Port 2:	WinDaq remote start/stop
Port 3:	Rate input
Port 4:	Count input

ADC Characteristics

Analog Inputs

Resolution:	12- to 16-bit Above zero ADC counts: 2,047 to 32,767 Below zero ADC counts: 2,048 to 32,768
Maximum sample throughput:	220 kHz (160 kHz throughput for analog channels, plus 20 kHz per enabled digital channel)
Minimum sample throughput:	Hardware only: 20 Hz WinDaq software: 2.2 samples per hour
Sample rate timing accuracy:	100 ppm

Digital Ports Programmed as Switch

Maximum drain voltage:	25 V
Maximum sink current:	100 mA

Count/Rate

Digital port assignment:	Count: Port 2 configured as input Rate: Port 3 configured as input
Internal pull-up value:	4.7 kΩ
Input high voltage threshold:	2.4V
Input low voltage threshold:	0.8V
Terminal count:	65,535
Maximum rate frequency:	50 KHz with one enabled channel, 20 KHz with 2-4 enabled analog channels, otherwise 10 KHz.
Minimum rate frequency:	0.5 Hz
Maximum count frequency:	50 kHz

Removable Memory

Type: MLC, pSLC, or SLC flash memory (with USB SD card reader); USB thumb drive

Required Format: FAT32

Indicators and Connections

Interface: USB 2.0 (mini-B style connector)

Status LED: Single multi-color LED

	Connecting	Idle	Recording	Armed	Rearmed	Busy	Error
USB	○ ●	● ●	● ●	● ●	--	—	● ●
Drive	○ ●	● ●	● ●	● ●	● ●	● ●	● ●

Input connections:	Two 16-position screw terminal strips
USB A Connector:	USB drive for stand-alone data logging
Button:	Multi-function control

Power

Power consumption: <1.0 Watt, via USB interface

Environmental

Operating temperature:	0 to 50 °C
Operating humidity:	0 to 90 %RH, non-condensing
Storage temperature:	-20 to 60 °C
Storage humidity:	0 to 90 %RH, non-condensing

Physical Characteristics

Enclosure:	Polycarbonate ABS, 0.080 inch thickness
Mounting:	Desktop; bulkhead
Dimensions (overall):	6.68W × 3.28D × 1.13H in 169.67W × 83.31D × 28.7H mm
Weight:	5.7oz. (162 grams)

Software Support

WinDaq Software:	OS support: Visit http://www.dataq.com/products/windaq/window-compatibility .
Programming:	Instrument protocol

Ordering Information

Description	Order No.
DI-2108 USB data acquisition (DAQ) system Includes instrument, 6-ft. USB cable, screwdriver, and WinDaq software via USB thumb drive or internet download (run. dataq.com)	DI-2108
MLC Flash Memory Card Low-speed micro SD flash memory card. Recommended for recording rates under 20 kHz throughput.	2000351
16GB pSLC Flash Memory Card High-speed micro SD flash memory card. Recommended for recording rates from 20 kHz throughput to 50kHz.	101014-16-MS
32GB pSLC Flash Memory Card High-speed micro SD flash memory card. Recommended for recording rates from 20 kHz throughput to 50kHz.	101014-32-MS
4GB SLC Flash Memory Card High-speed micro SD flash memory card. Recommended for recording rates over 50 kHz throughput.	101014-4-HS
8GB SLC Flash Memory Card High-speed micro SD flash memory card. Recommended for recording rates over 50 kHz throughput.	101014-8-HS
Flash Card Reader Flash memory card reader for micro SD cards.	2000352
WinDaq/Unlock Unlocks WinDaq to allow recording all the channels available on your device. Unlock Code ONLY	WinDaq/Unlock 2108
Stand-alone Enabled Unlocks stand-alone capability (recording all channels to USB thumb drive) and all the channels on the device (WinDaq/Unlock).	SA-Enabled-2108



DATAQ Instruments, Inc.
 241 Springside Drive
 Akron, Ohio 44333
 Phone: 330-668-1444
 Fax: 330-666-5434

Data Acquisition Product Links

(click on text to jump to page)

[Data Acquisition](#) | [Data Logger](#)