

# DI-4208M USB or Ethernet Data Acquisition System



- ✓ Eight armored analog differential inputs\*
  - ✓ Programmable range per channel:  $\pm 2, 5, 10, 20, 50, 100$  V full scale
  - ✓ Up to 120 Vrms without damage
  - ✓ 50 dB common mode rejection
- ✓ Supports ChannelStretch™ multi-unit synchronization\*
- ✓ PC-connected or Stand-alone operation to removable USB flash drive
- ✓ USB, Ethernet, or Power over Ethernet interface options
- ✓ Adaptable low-pass filter per channel
  - ✓ Corner frequency set as a function of sampling rate
- ✓ 16-bit analog-to-digital resolution
- ✓ 160 kHz analog sample throughput rate
- ✓ Seven digital ports
  - ✓ Programmable per port as input or switch
  - ✓ Support for rate measurements to 50 kHz
  - ✓ Support for 16-bit counter
- ✓ Software support includes:
  - ✓ Ready-to-run WinDaq software
  - ✓ Published protocol

\* WinDaq/Unlock required per device to use ChannelStretch™ when using WinDaq software.

## Overview

The DI-4208 is a follow up product to [model DI-2108](#). The two are functionally identical except that the DI-4208 offers programmable gain per analog channel and supports [ChannelStretch™ channel expansion](#). Suitable for a wide range of analog and discrete measurements, the DI-4208, in tandem with the included WinDaq software, allows real time data acquisition, playback, and analysis performance that covers an incredibly broad array of applications in both laboratory and industrial settings. With all eleven scan list items enabled (8 analog channels, one each counter and rate, and all discrete input ports in the remaining position) a total sample throughput rate of 220 kHz is supported.

## Analog Subsystem

Model DI-4208 delivers premium analog performance at a surprisingly affordable price. Eight analog input channels provide differential measurement flexibility and programmable ranges per channel of  $\pm 2$ ,  $\pm 5$ ,  $\pm 10$ ,  $\pm 20$ ,  $\pm 50$ , and  $\pm 100$  V full scale. The differential input configuration provides noise rejection, easily adapts to single-ended signal sources, and is protected to 120 V rms so that inevitable measurement mishaps will not harm the instrument. The front end feeds a variable resolution analog-to-digital converter that ranges from 12 to 16 bits as a function of sampling rate. Lower sampling rates deliver higher resolution readings. The maximum analog sampling throughput rate of the DI-4208 analog subsystem is 160 kHz, providing 12 bits of resolution. Below 10 kHz the instrument delivers 16-bit resolution with a single enabled analog channel. Below 2 kHz per analog channel the DI-4208 provides 16-resolution with five or more enabled analog channels. See inside for details. Rounding off the analog subsystem are low-pass filters per channel with automatic corner frequency selection as a function of sampling rate. All these features combine to provide pure data acquisition power at an unmatched price point.

## Digital I/O Subsystem

The DI-4208 provides 7 digital ports, each configurable as an input or a switch. Input protection is provided to 25 V. When activated as inputs two ports allow dual functionality as discrete inputs, or can be programmed as a counter or rate input respectively. The rate input features a 50 kHz maximum measurement, allocated over twelve programmable measurement ranges (10 Hz to 50 kHz full scale.) The counter input provides 16-bit resolution and a terminal count value of 65,535. The discrete, counter, and rate inputs are members of the same internal scan list used by the analog input channels. This means that all enabled elements are acquired synchronously, which allows meaningful comparisons between analog and digital channels. For example, the rate input measuring engine speed allows rpm data to be acquired in lock-step with analog data. Configured as a switch a digital port can be used to control external loads up to 25 V @ 100 mA, and the switch can be controlled asynchronously during scanning.

## Stand-alone Operation

A USB drive is used to record data in stand-alone mode. The DI-4208 can record continuously using a circular buffer with pre-defined trigger conditions or a record-until-full approach supporting remote start/stop. A push button allows manual start/stop control over the recording process. With a flash memory card incorporating SLC technology, throughput rates up to 160 kHz can be achieved. That rate drops to 50 kHz when using pSLC card, and 20 kHz using a flash memory card incorporating MLC. The included WinDaq data acquisition software makes configuring the DI-4208 for stand-alone operation quick and intuitive. Use WinDaq to set up channels and create a reference file. That reference file can then be copied to the USB drive and used for quick setup.

## Software Overview

Model DI-4208 is provided with comprehensive software support. For point-and-click, ready-to-run applications the DI-4208 is supplied with our popular WinDaq software. WinDaq allows a real time display of any combination of analog channels, and the ability to stream acquired data to disk in recorder-like fashion, even at the fastest rate supported by the hardware. This is true streaming performance, continuous, without gaps, and simultaneously to both the real time display and disk. Record only a few readings, or as many as 4 GB. The DI-4208 reserves two digital inputs for WinDaq software that are dedicated for remote stop/start and remote event operations. WinDaq also includes software to review recorded data files, including waveform analysis and data file export to Microsoft Excel and other applications. Custom programming the DI-4208 is supported through its protocol documentation. Finally, the DI-4208's ChannelStretch™ technology allows multiple instruments (DI-4208, -4108, -4730, -4718B) to be synchronized to expand channel count without clumsy external cabling (details inside).

## Interface Options

The DI-4208 provides three interface options: USB, Ethernet, and Power over Ethernet. All 3 have stand-alone capability (optional Unlock Code required to record more than one channel to flash memory) to record to flash memory.

USB allows for quick plug-and-play access to your DI-4208. Using ChannelStretch™ technology, and cascading multiple USB hubs, add up to 15 additional instruments (a total of 128 analog channels and 105 digital ports) with a maximum throughput sample rate  $\geq 480$  kHz.

Ethernet allows you to access your DI-4208 over much greater distances (up to 100 meters between stations). Connect directly to a PC, to a LAN port, or wirelessly using an access point. Using wireless hubs and ChannelStretch™ technology, you can add up to 15 additional units at throughput sample rates  $\geq 50$  kHz.

Power over Ethernet (PoE) gives you the same functionality as the standard Ethernet connection, but also provides power to the DI-4208 using a PoE-enabled switch. This eliminates the costly expense of running power to a remote location where data acquisition may be essential.

## DI-4208M Major Features and Benefits

### **Eight Analog Input Channels**

Measure as many as eight system variables at once with programmable ranges per channel of  $\pm 2$ ,  $\pm 5$ ,  $\pm 10$ ,  $\pm 20$ ,  $\pm 50$ , and  $\pm 100$  V full scale.

### **Differential Analog Input Configuration**

Enhanced noise immunity and tolerance of common mode voltages.

### **12- to 16-bit Measurement Resolution**

One product addresses your measurement needs, from low to high resolution, as a function of sampling rate.

### **Armored Inputs Absorb Mistakes**

Both analog and digital inputs are protected to 100 V and 0-25 V dc respectively.

### **Fast 160 kHz Sample Throughput Rate**

Observe fast phenomena that other products in the DI-4208's price range would miss.

### **Stand-alone Data Logger Operation**

Store data to flash drives at throughput rates up to 160kHz.

### **15V Excitation Supply**

4208M provides 15V excitation for sensors.

### **Pre/Post Trigger Storage to USB Memory**

Set trigger levels to record up to 2G (combined) of pre- and post-trigger data (total file size of 4G)

### **Auto Re-Trigger**

When using Triggered Storage, triggers can automatically reset, creating a new file with pre and post trigger data each time the trigger level is breached.

### **Industrial Oriented**

DI-4208-M comes with easy signal swapping connectors, stackable rugged enclosure and ground lug to provide better EMC immunity in harsh environment.

### **Supports ChannelStretch™ Channel Expansion\***

Connect as many as sixteen DI-4108s, DI-4208s, DI-4718Bs, and/or DI-4730s to one PC. Synchronously acquire from as many as 128 and 112 analog and digital channels respectively.

### **Seven Digital Input Ports\***

Folds discrete I/O into the measurements process. Each bit is programmable as an input or as a switch and protected to 0-25 V dc.

### **Asynchronous Digital Switches**

Control external processes seamlessly while acquiring data.

### **Counter Channel**

Tallies the number of pulses applied. Useful for integrating rate information, like flow rate to volume, or simply the number of definable events.

### **Rate Measurement Channel**

Measures pulse rate where frequency carries information. For example rpm or flow measurements.

### **Optional Power over Ethernet (PoE)**

The optional Power over Ethernet feature allows you to both communicate with and power the DI-4208 via the Ethernet connector, sparing the inconvenience and expense of running power to the unit.

### **Ready-to-run Software Support\***

Provided with ready-to-run WinDaq software for point-and-click DAQ performance with a real-time display, disk-streaming recording, and playback and analysis.

\* WinDaq/Unlock required per device to use ChannelStretch™ and to record more than four total channels when using WinDaq software.

# DI-4208 Close-up

**Digital I/O Channels 0-6**  
 D0 Event Markers in WINDAQ  
 D1 Remote Start/Stop in WINDAQ  
 D2 Can be used for Rate applications  
 D3 Can be used as a Counter channel  
 D4-D5 are general-purpose digital I/O  
 D6 Can be used as an External Trigger

**USB Drive**  
 Accepts any USB flash drive or USB reader for stand-alone data logging (requires AC power supply)

**Ethernet Connector (Ethernet models)**  
 Standard RJ45 connector. Power over Ethernet option available. Ethernet Connector not available on USB model.

Bulkhead Mounting Ears

Mini-B **USB** connection Powers the device and connects to your PC for USB recording to PC. Cannot be used when recording to the USB Drive

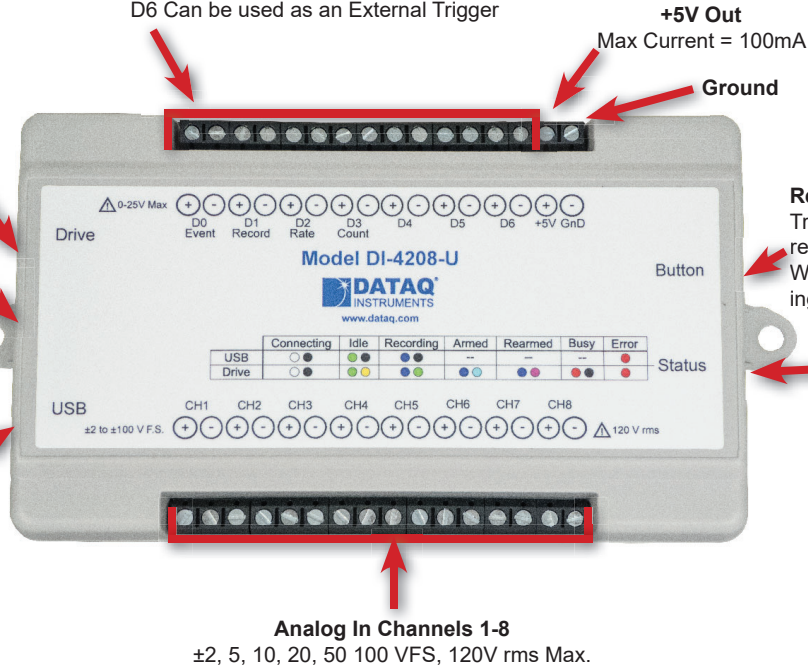

**Digital I/O Channels 0-6**  
 D0 Event Markers in WINDAQ  
 D1 Remote Start/Stop in WINDAQ  
 D2 Can be used for Rate applications  
 D3 Can be used as a Counter channel  
 D4-D5 are general-purpose digital I/O  
 D6 Can be used as an External Trigger

**Analog In Channels 1-8**  
 ±2, 5, 10, 20, 50 100 VFS, 120V rms Max.

**Ethernet Connector**  
 Standard RJ45 connector. Power over Ethernet option available.

Chasis Ground Lug

Mini-B **USB** connection Powers the device and connects to your PC for USB recording to PC. Cannot be used when recording to the USB Drive

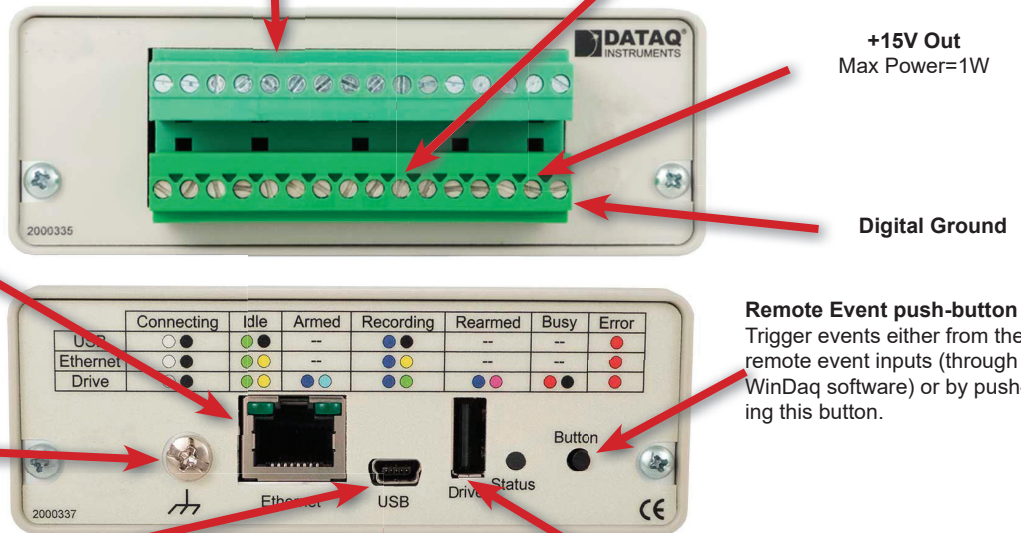



# Analog-to-digital Converter Characteristics

DI-4208 ADC resolution is a function of sampling rate: Slower sampling rates yield higher resolution measurements. The DI-4208 achieves this using its real time CIC decimation filter to improve signal-to-noise ratio and to increase measurement resolution. Before the DI-4208 such techniques were reserved only for high-end instrumentation because of the cost of processing power required to provide meaningful, multi-channel results in real time. But that cost has been driven down dramatically so that the 120 MIPS processor embedded in the DI-4208 is both affordable and more than adequate for the task.

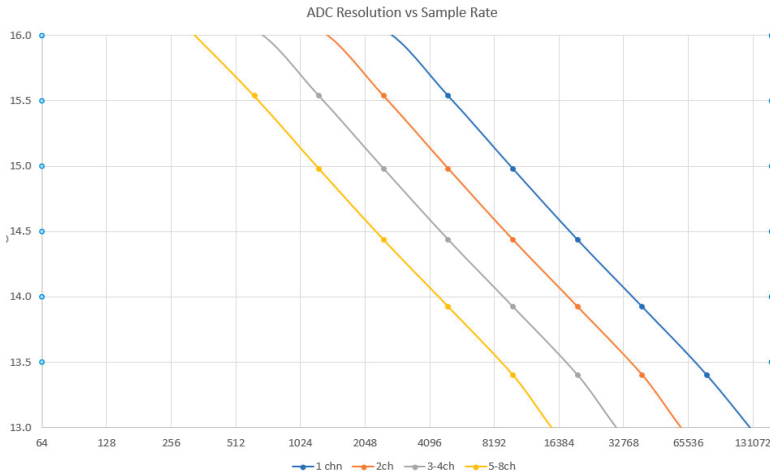

ADC resolution (R) is a function of selected sample rate per channel (F), and the number of enabled analog channels (C):

$$R = \frac{\log\left(\frac{160000}{FC}\right)}{\log(4)} + 12$$

Where:

| C | Enabled Channels |
|---|------------------|
| 1 | 1                |
| 2 | 2                |
| 4 | 3-4              |
| 8 | 5-8              |

## Synchronize Multiple Instruments with ChannelStretch™ Technology

Need more channels? Add more instruments in any combination of DI-1120, DI-4108, DI-4208, and DI-4718B models. Add up to fifteen more instruments for a total of 128 analog channels and 112 digital ports to a maximum throughput rate  $\geq 480$  kHz using the DI-4108's ChannelStretch™ technology (see Specifications section for configuration details). Multiple instruments connected to the same USB hub or Ethernet switch automatically synchronize to within 10  $\mu$ s between units. If you need more ports to accommodate more units, simply cascade multiple hubs or switches to expand port count. Best of all, when using WinDaq software the enabled channels of all synced units flow into the same WinDaq application. They're displayed and stored together as though they all originated from a single instrument. The WinDaq/Unlock option per instrument is required to synchronize when using WinDaq software.

### ChannelStretch™ Technology

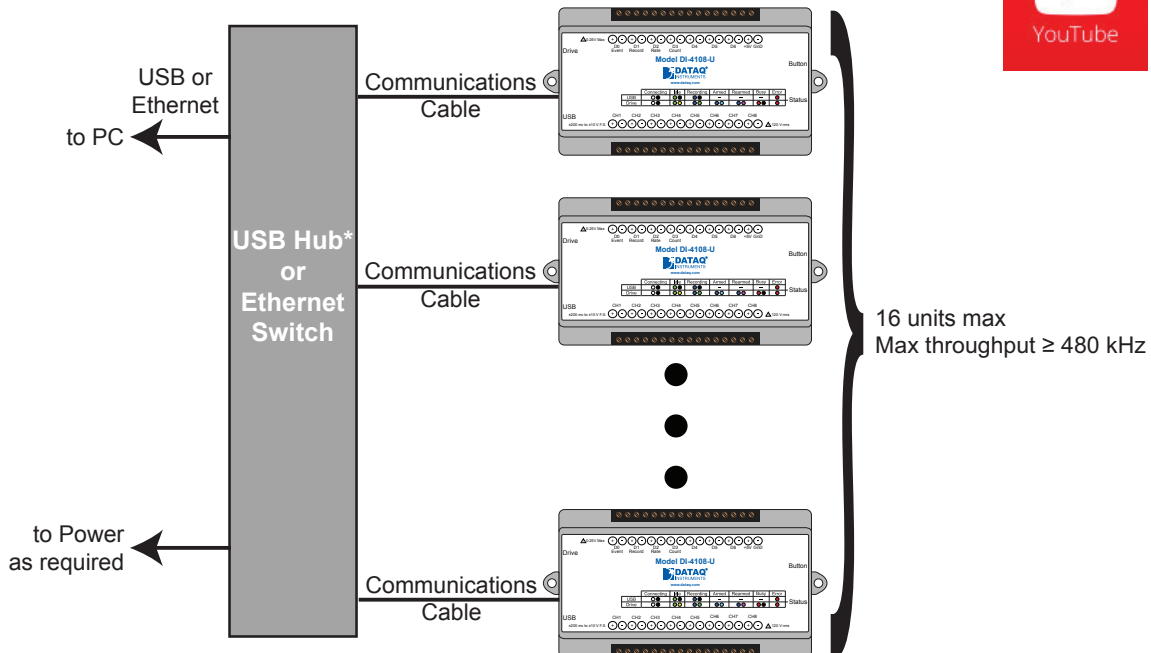

\*DATAQ Instruments 7-port USB hub (part number 2000310). Cascade for a higher port count.

# DI-4208M Analog Measurements

Eight analog input channels each with a programmable measurement range of  $\pm 2, 5, 10, 20, 50, 100$  V full scale are supported by the DI-4208. Though not isolated inputs, each offers differential input capability with some rejection of common mode voltages (those that appear simultaneously and in-phase on both inputs). These channels are also hardened to tolerate excessive voltages to protect against wiring mishaps.

## Traditional Chart Recorder Replacement

Digitize and record measurements from instruments with high-level analog outputs.

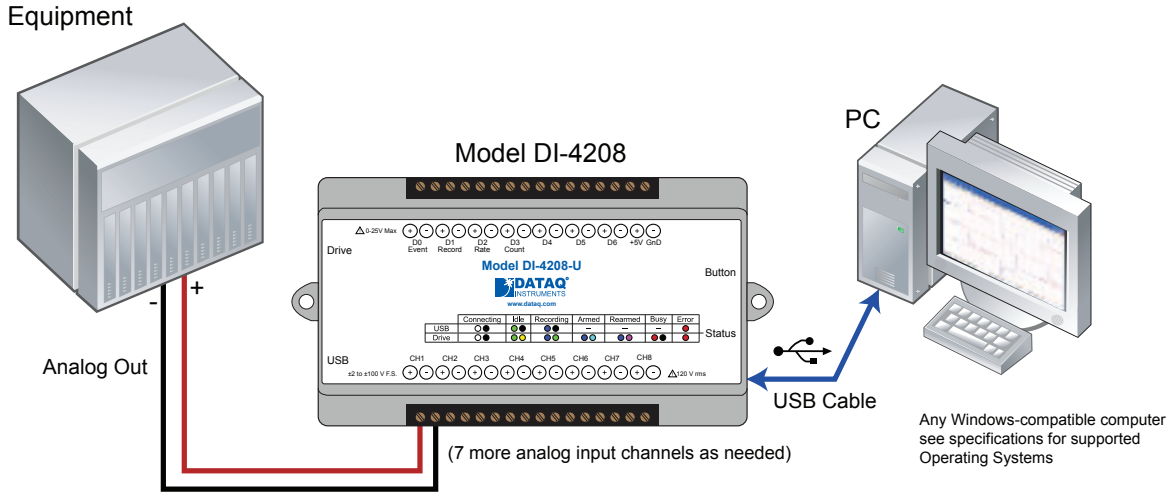

Examples of “Equipment” above include gas chromatographs, liquid chromatographs, spectrometers, bio-amplifiers\*, etc.

\* DATAQ Instruments’ hardware and software products are NOT designed to be used in the diagnosis and treatment of humans, nor are they to be used as critical components in any life support systems whose failure to perform can reasonably be expected to cause injury to humans.

## Process Monitoring

Trend plot and record control and feedback signals to troubleshoot process glitches.

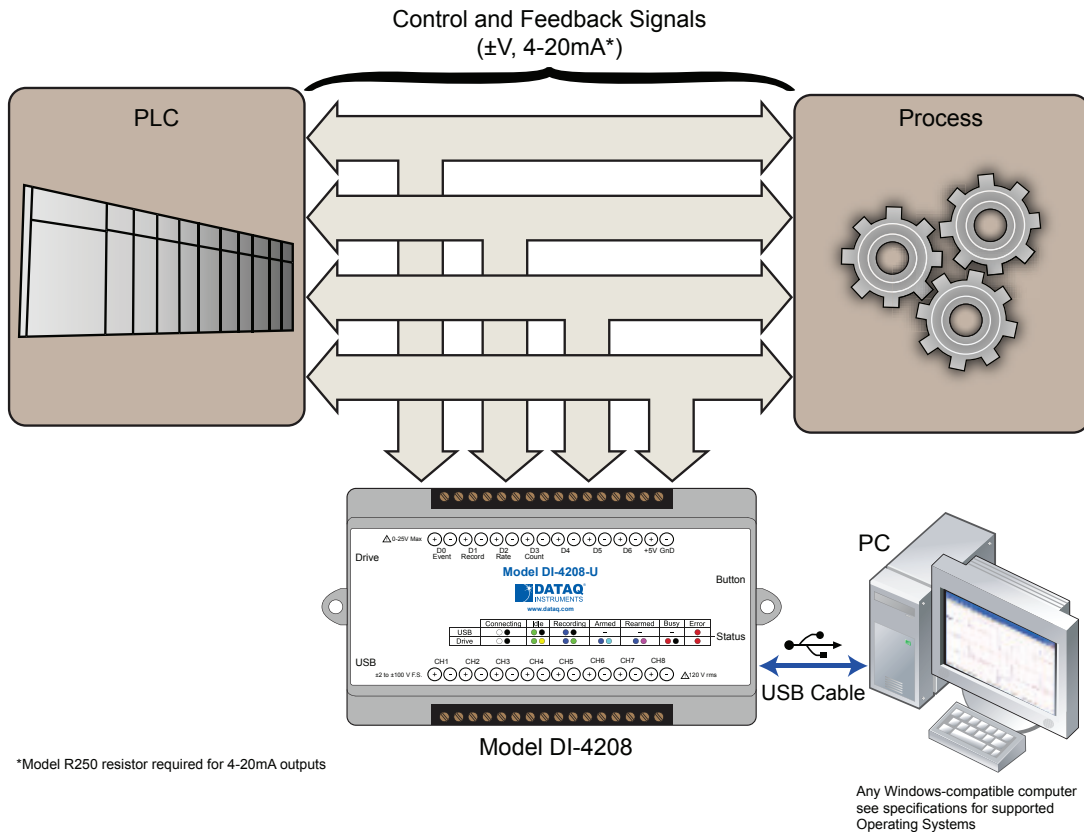

## Typical Analog Measurements

### 4-20mA current (low-side shunt)

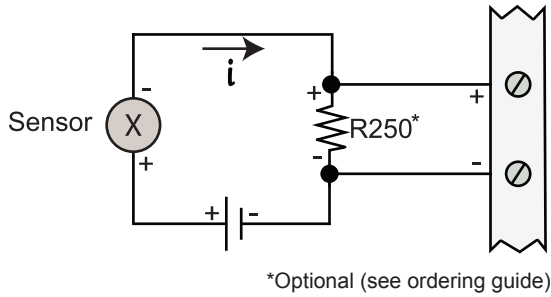

### Voltage source

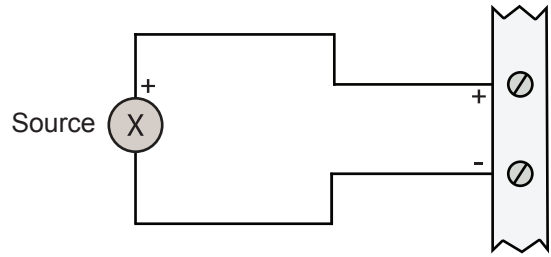

## General-purpose Digital Port Operation

Each DI-4208 digital port can be configured as a digital input or used as a switch to control an external load. Ports are configured by a MOSFET that defines the port's function, where the MOSFET is either on or off. When the MOSFET is off the port is available as a discrete input. Turning the MOSFET on allows the port to function like a switch for loads up to 25 V and 100 mA. Care should be exercised when configuring the load to be switched to ensure that the digital port is not damaged:

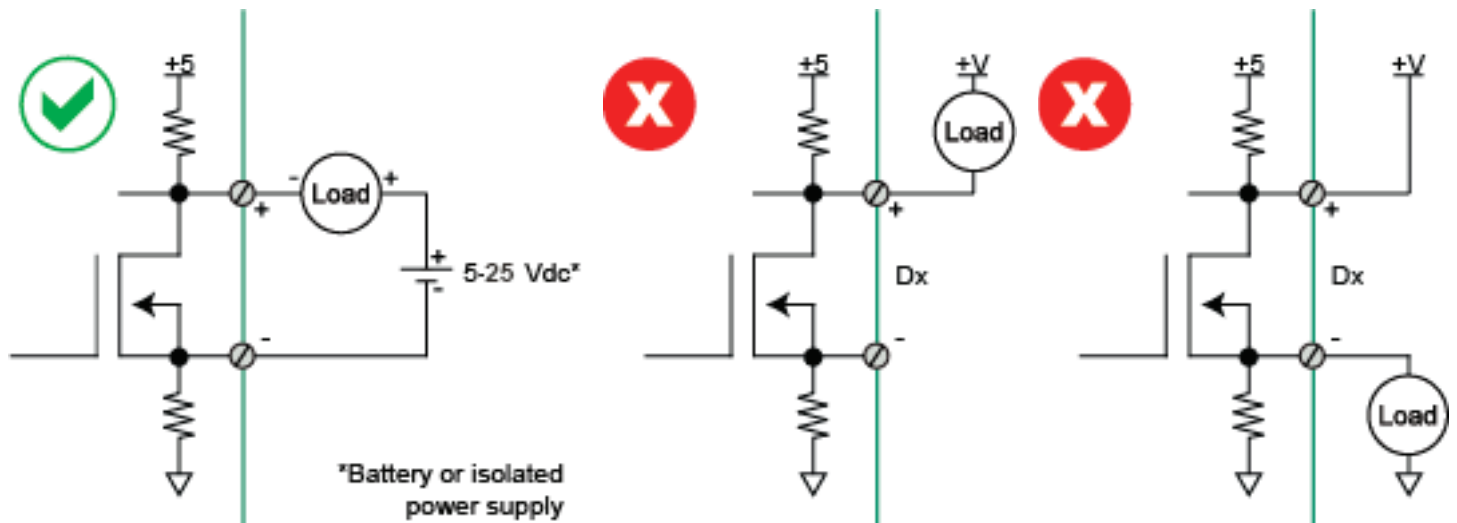



## DI-4208M Rate and Count Measurements

Digital ports D2 and D3 can be programmed for multiple functions. Both can be programmed as discrete inputs or outputs. In addition, port D2 can be programmed as a rate input and port D3 as a counter input. When programmed to measure rate and/or count the DI-4208 adds these measurements to its internal scan list along with any other analog or digital data so that all measurements are acquired in the same time frame. Rate measurements in the range of 10 Hz to 50 kHz are possible across twelve programmable full scale ranges. Use the rate input to extract rpm data from a rotating device, or to acquire flow information from a pulse-type flow sensor. Count measurements up to 65,536 are supported by the D3 port. Use count to integrate flow to get volume, or use it simply to tally events in a given process.

### Rpm from rate

The DI-4208's Rate input is used to acquire a frequency representing rpm, flow, or any other pulse stream.

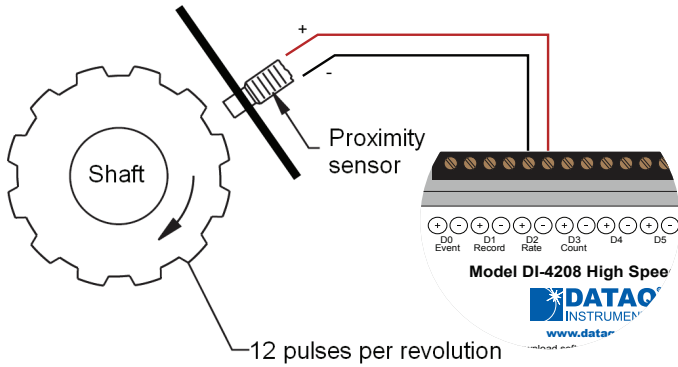

### Flow/volume

Use the DI-4208's Count input to accumulate a tally of applied discrete pulses to track test cycles, extract volume from flow, or any other general-purpose totalizing application.

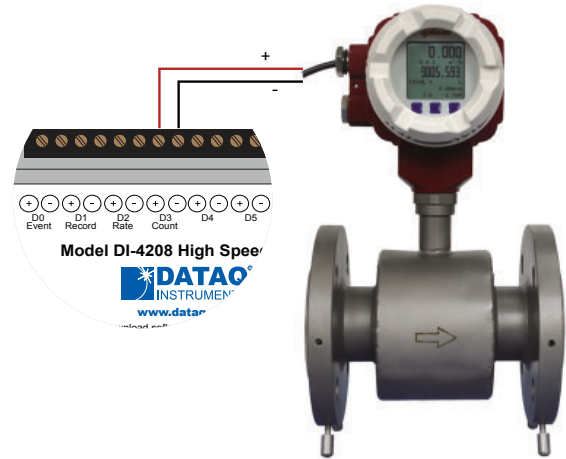

## Remote Control Close Up

The DI-4208 supports several methods to increase measurement flexibility and data record interpretation. The remote record feature allows you to synchronize WinDaq recordings to external processes by remotely enabling and disabling WinDaq's stream-to-disk feature. Remote events allow you to insert an event marker in the data stream (see inset) to identify when an event occurred relative to recorded waveform activity. Events can be activated by the pushbutton on the DI-4208 enclosure, though a keyboard keystroke (which also allows you to record a description), or remotely via the remote event input. The stream-to-disk function can also be controlled through the keyboard, or through the remote record input. Valid remote record and event signals are switch closures, or discrete levels with a maximum input of 25 V. Finally, each port is internally pulled-up, so it's easy to use with external dry-contact switches.

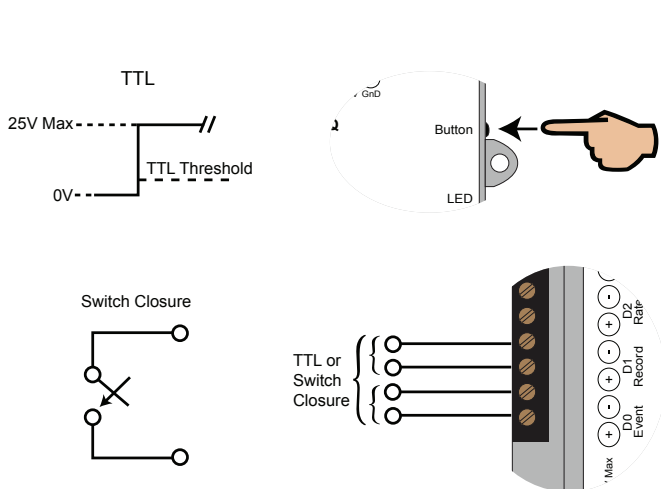

## Stand-alone Data Logger Operation

A USB drive can be used to record and store up to 32GB of data. The DI-4208 can record continuously using a circular buffer (with pre-defined trigger conditions) or record-until-full approach. A push button allows manual start/stop control over the recording process. A multi-color LED shows the status of the DI-4208 (Record, Standby, Busy, Error).

Varying degrees of flash memory technology will influence performance when recording in stand-alone mode. With a flash memory card incorporating SLC technology, throughput rates up to 160 kHz can be achieved. That rate drops to 50 kHz when using a pSLC card, and 10 kHz using a flash memory card incorporating MLC or some other branded technology.

| Flash Technology | Speed        |
|------------------|--------------|
| MLC/Generic      | Up to 20 kHz |
| pSLC             | Up to 50 kHz |
| SLC              | >50 kHz      |

## Triggering with Stand-alone Operation

Set a trigger and the amount of pre and post trigger data scans to capture only the data you want.

With a trigger and number pre/post trigger scans selected, you can capture just the data you're interested in, before and after an event occurs. Choose a trigger level on any analog channel and acquire up to 2 G of pre and post trigger data to a USB drive. You can choose a trigger channel, trigger level and the number of pre and post trigger scans. The auto rearm option enables you to continuously create new files each time the threshold level is breached.

This is particularly useful in the case of a destructive test. For example, when ramping up current to a motor until a failure occurs, you're likely interested in how the motor behaved just prior to the failure, and what happened immediately thereafter. Was the failure gradual, or sudden? Were there indicators leading up to the failure? Triggered storage allows you to hone in on that information.

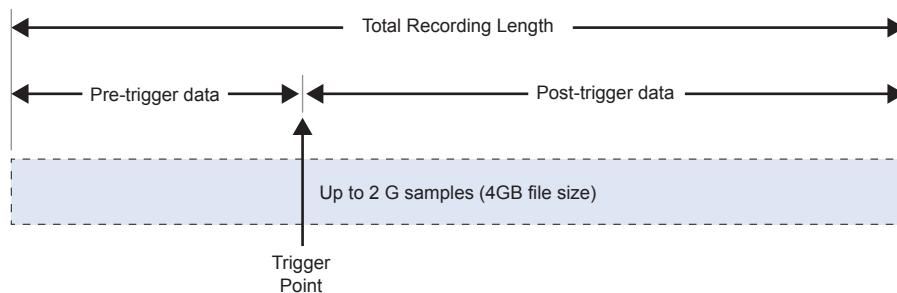

Specify the trigger channel, level, rising or falling slope.

### Rising Slope

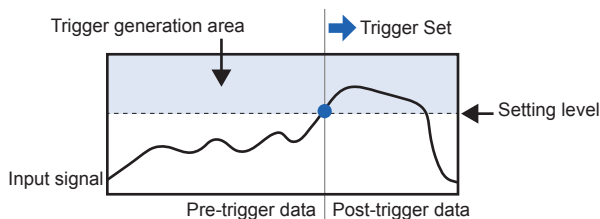

### Falling Slope

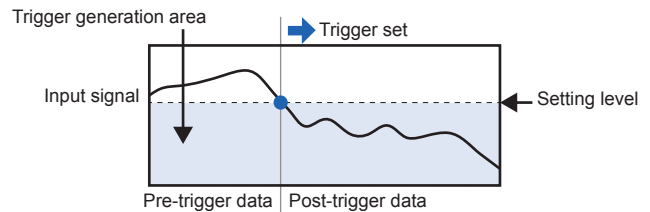

## Stand-alone Setup

The stand-alone configuration for both USB and Ethernet versions of the DI-4208 is performed using the WinDaq Dashboard. With the DI-4208 plugged into an available USB port or accessible Ethernet port, run the WinDaq Dashboard, select the device you would like to configure, and select “Stand Alone Setup” from the “Configure” menu. Configurable settings include:

- Enable analog channel and setup - including selection of gain (measurement range), reporting mode (average, last point, max, min), and user annotation.
- Enable digital channel for remote storage and events or general-purpose discrete inputs.
- File Storage mode including record on trigger conditions.
- Sample Rate selection as sampling interval.
- File Storage Format: WinDaq or CSV.
- Record on Power Startup option.
- Immediate Start Recording button for Ethernet-connected devices.
- Save Configuration and Load Configuration utility.

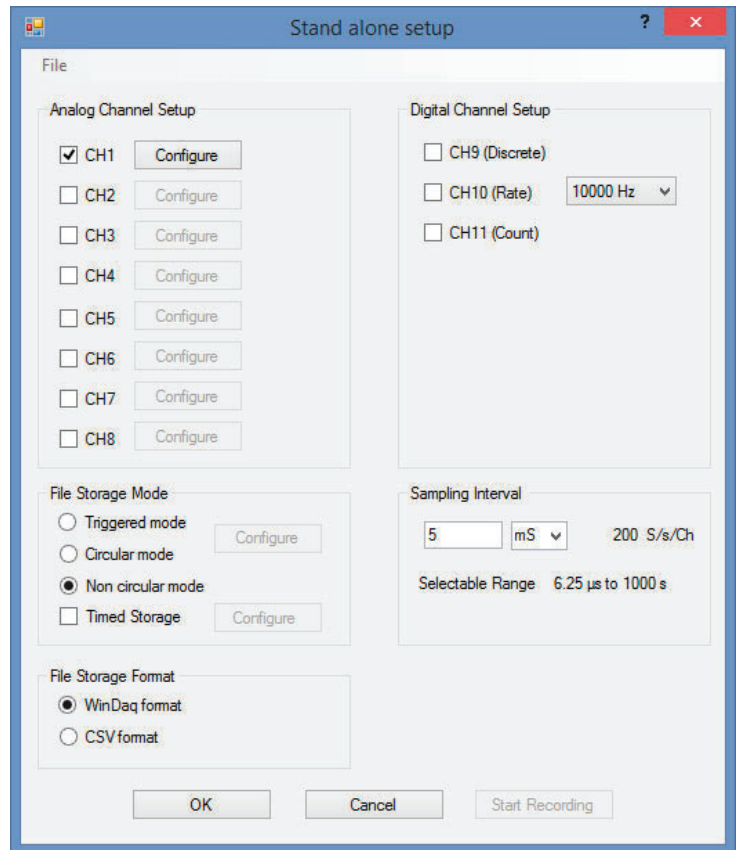

## Ethernet Settings

The network configuration (assigning an IP address, subnet mask, etc.) can be performed from the WinDaq Dashboard. This provides easier setup on any Local Area Network. Connect the DI-4208 device via the USB port, set the IP address of the device, and then deploy the device on your network.

Alternatively, a JSON file (the JSON file must be named network.json) can be used to load the network configuration. The JSON file can be created using any text or JSON editor, and then placed on a USB flash drive.

With the DI-4208 in Stand-alone/Ethernet mode, press down and hold the control button while inserting the USB drive. This will force the device to retrieve any available configuration files from the drive.

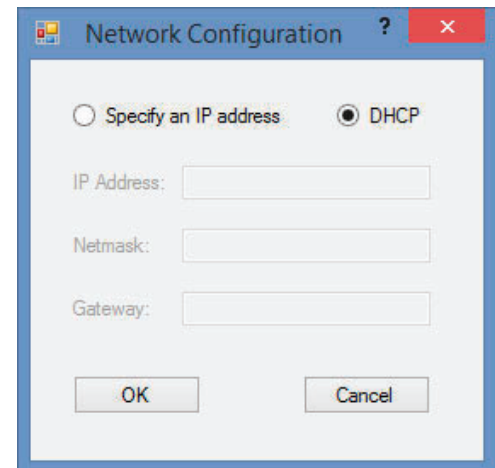

```
{
  "Network": {
    "IP": "192.168.0.196",
    "Netmask": "255.255.255.0",
    "Gateway": "192.168.0.1"
  }
}
```

## Setup\*

Double-click and enter the channels you want to acquire into the WinDAQ scan list, even from multiple units with Channel-Stretch™. Click to select signal averaging, maximum, minimum, or last point operation per channel. Click to define a single to 8-channel display - either triggered sweep (oscilloscope-like) or scrolling (chart recorder-like). Click again to define a sample rate ranging from two samples per hour to 160 kHz throughput per device.

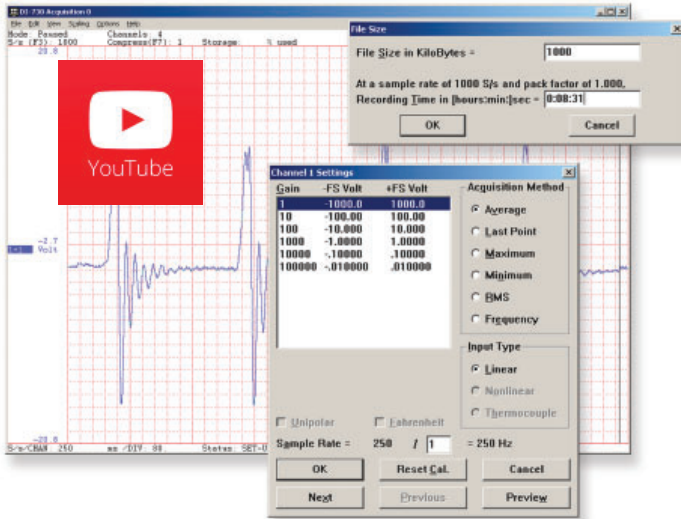

## Calibrate

Define calibration per channel to display waveform values in meaningful units such as psi, °F or °C, amps, rpm, watts, horsepower — any unit of measure you need.

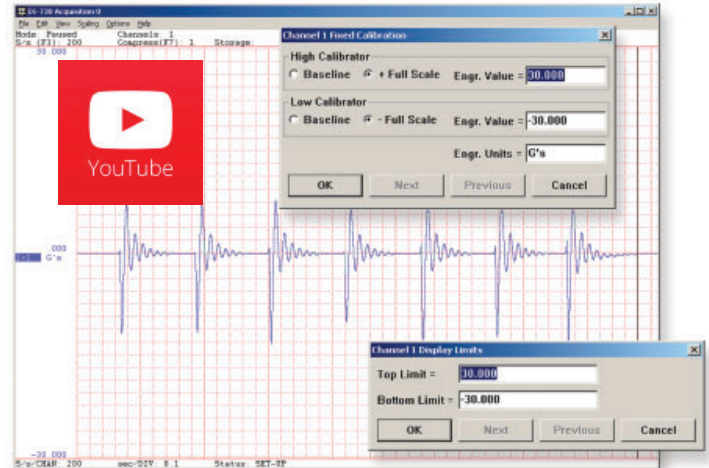

## Record

Choose a continuous waveform recording mode or the triggered mode with selectable trigger level, slope, and post-trigger times. WINDAQ automatically time- and date-stamps, then streams acquired data to disk — record as much data as you need. At the same time, WINDAQ supplies a real-time graphical display of any or all channels so you always know where you are and where you're going.

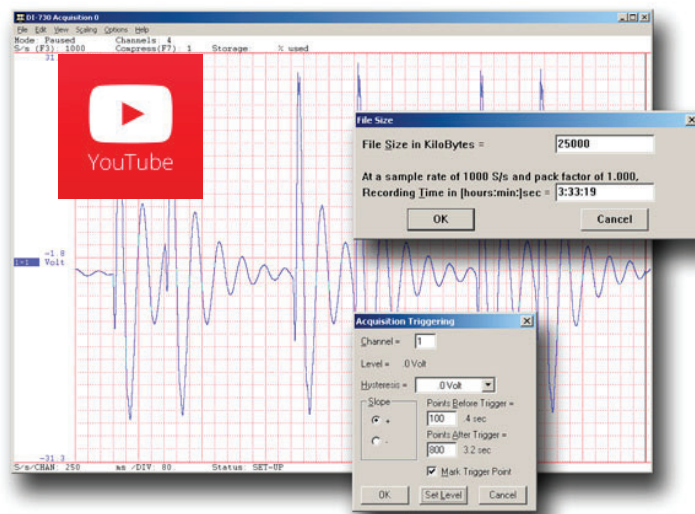

## Annotate

Of course, you can label any channel with text that describes it — “Motor 1,” “Engine speed,” “Vertical position,” etc. But WINDAQ also allows you to supply commented event markers while you record — “Beginning test phase 1,” “Small vibrations noticed,” “Starting cool-down cycle,” etc. Your comments and our acquired data combine to form a complete diary of your data acquisition session.

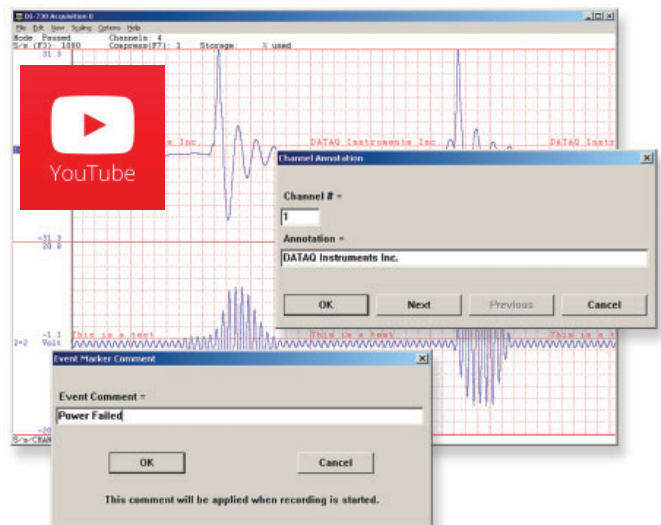

\* WinDAQ/Unlock required per device to use ChannelStretch™ and to record more than four total channels when using WinDAQ software.

## Playback

Recording is only half the solution. WINDAQ's Waveform Browser playback software allows you to graphically manipulate waveforms in ways you've never seen on a PC. Compress an entire recording to one screen-width for a bird's eye view, then expand around an area of interest for a closer look. Use the cursor to measure amplitudes and timing with precision. Move to any event marker with the click of a mouse button.



## Multitask

Double your productivity and let WINDAQ record while you review last week's results from your spreadsheet, or compose a memo with your word processor. You can even play back data already stored to disk while you're still recording.

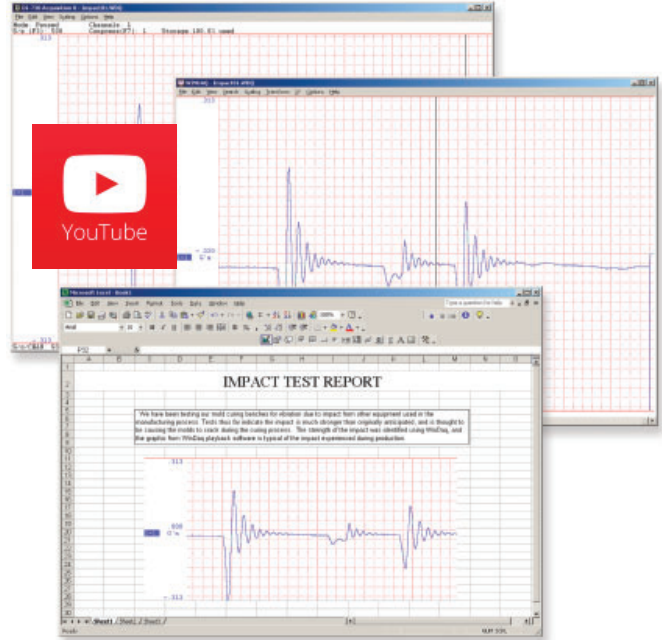

## Analyze

Waveform interpretation is easy with our built-in analysis functions. Apply frequency and filtering analysis with the WINDAQ Waveform Browser FFT and DFT functions. Analyze any range of waveform data with the statistics function. Use X-Y plotting to examine the relationship of one channel to another. Optional Advanced CODAS analysis functions allow waveform peak detection, integration, differentiation, arithmetic operations, and more.

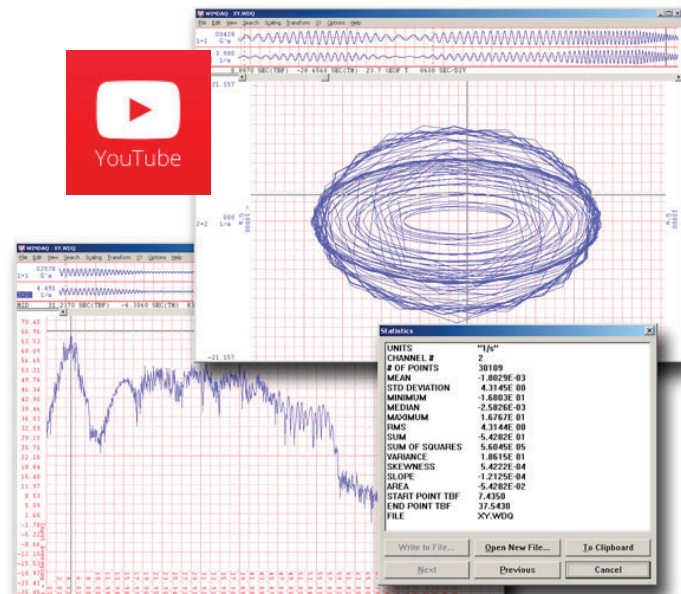

## Export

The WINDAQ Waveform Browser can export any range of data to your spreadsheet, or any other analysis or presentation package you use. You can even copy a graphical image displayed by the WINDAQ Waveform Browser and paste it directly into a word processing document. Finally, export any range of waveform graphics to your printer for a hard copy record.

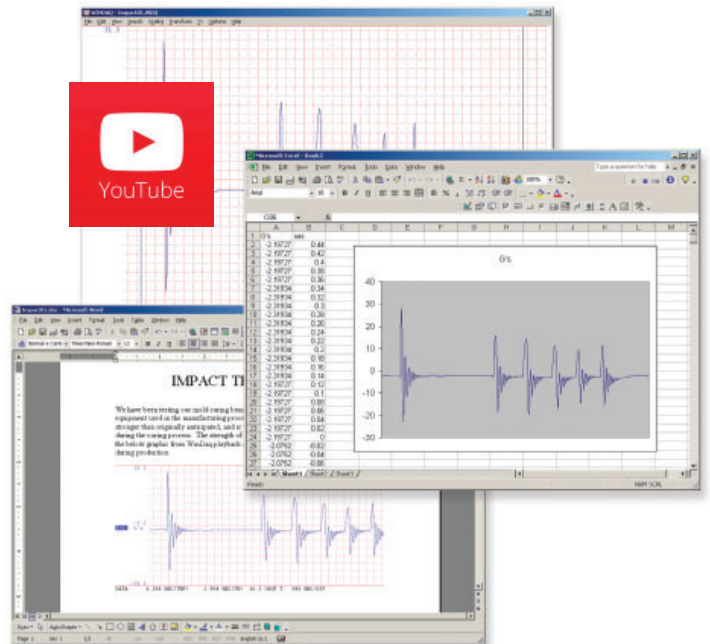

## Four Analog Channel Reporting Modes

The DI-4208 can be configured per channel to report just the last sample acquired like other data acquisition products. Unlike other products three additional reporting modes, selectable per analog channel, provide much more flexibility when reporting oversampled data:

### Anti-alias filter

Oversampled data is passed through the DI-4208's anti-alias CIC filter. Use this mode to dramatically reduce the unwanted effects of alias frequencies and noise.

### Maximum value

Oversampled data is evaluated for the maximum value. Use Maximum to peak-detect complex waveforms.

### Minimum value

Oversampled data is evaluated for the minimum value. Use Minimum to valley-detect complex waveforms.

All four operating modes are supported by WinDaq software. And, since they are applied by DI-4208 firmware, custom programs can easily leverage these features without incremental programming overhead.

## Published Protocol

Sometimes you can't use a ready-to-run application like WinDaq. You need to develop your own software to perform in precisely the way you need. That requirement defines the need for programming support so you have the tools necessary to move forward.

### Included DI-4208 Protocol Documentation

As you probably suspect when you run our point-and-click WinDaq data acquisition software, there's a lot going on beneath the surface. WinDaq software needs to take the data acquisition configuration that you design using its menu system and communicate that to the hardware. These are things such as sample rate, the number of channels enabled, the specific channel numbers enabled, etc. Diving down to the lowest level of program activity, past the WinDaq user interface, beyond the device driver to the actual commands sent to the data acquisition hardware and the format of the responses they evoke, is the protocol. The protocol defines the exact set of commands a program can send to the hardware, and how the hardware will react as a result. So, if you know the command and response definitions for the DI-4208 (i.e., its protocol), the instrument can be folded into virtually any operating system and any programming language

# DI-4208M Specifications

## Analog Inputs

Number of Channels: 8  
 Configuration: Differential  
 Full Scale Range:  $\pm 2, 5, 10, 20, 50, 100$  V full scale  
 Input impedance: 798 k $\Omega$   
 Absolute accuracy: 0.25% of full scale range  
 @ 25°C, excluding common mode error  
 Absolute maximum input without damage: 120 V rms (normal mode + common mode)  
 Maximum common mode voltage:  
 Common mode range:  $\pm 20$  V dc or peak ac  
 Common mode rejection ratio: 50 dB (dc - 60 Hz)  
 Channel-to-channel crosstalk rejection: -80 dB

## Digital Inputs

Total port count: 7  
 Type: MOSFET switch  
 Threshold levels: TTL-compatible  
 Absolute maximum applied voltage (V): 25 V dc

## Digital Ports

Total port count: 7

## Programmed as a Switch

Maximum drain voltage: 25 V  
 Maximum sink current: 100 mA

## Count/Rate/Inputs

Internal pull-up value: 4.7 k $\Omega$   
 Input high voltage threshold: 2.4 V  
 Input low voltage threshold: 0.8 V  
 Terminal count: 65,535  
 Maximum rate frequency: 50 KHz with one enabled channel  
 20 KHz with 2-4 enabled channels  
 10 KHz with 5-7 enabled channels  
 Minimum rate frequency: 0.5 Hz  
 Maximum count frequency: 50 kHz

## Reserved Digital Inputs

D0: WinDaq remote events  
 D1: WinDaq remote start/stop  
 D2: Rate input  
 D3: Count input

## Indicators and Connections

**Button:** Multi-function control  
**USB A Connector:** USB drive for stand-alone data logging  
**Status LED:** Single multi-color LED

|          | Connecting | Idle | Armed | Recording | Rearmed | Busy | Error |
|----------|------------|------|-------|-----------|---------|------|-------|
| USB      | ○●         | ●●   | —     | ●●        | —       | —    | ●●    |
| Ethernet | ○●         | ●●   | —     | ●●        | —       | —    | ●●    |
| Drive    | ○●         | ●●   | ●●    | ●●        | ●●      | ●●   | ●●    |

**USB Connector:** USB 2.0 mini-B connects to PC or for power with adapter  
**Ethernet Connector:** RJ45; Optional PoE

## ADC Characteristics

Resolution: 12- to 16-bit  
 Above zero ADC counts: 2,047 to 32,767  
 Below zero ADC counts: 2,048 to 32,768  
**Max. throughput sample rate:** Standard: 160 kHz  
 Stand-alone: 20 kHz to 160 kHz\*  
**Min. throughput sample rate:** Standard: 20 Hz (2.2 samples per hour with WinDaq)  
 Stand-alone: 0.0017 Hz  
 Sample rate timing accuracy: 100 ppm

## ChannelStretch™ Operation USB

**Total Max Units:** 16  
**Max Channel Count:** 128 Analog, 112 Digital  
**Max Throughput:**  $\geq 480$  kHz  
**Synchronization Conditions:** Syncs with any combination of DI-4730, DI-4108, DI-4208, and DI-4718B USB instruments.  
 All synced instruments must operate at the same sample rate per channel, regardless of channel number, type, or range.  
 All instruments must be connected to the same USB controller. The use of USB hubs are recommended to meet this requirement.

## Ethernet

**Total Max Units:** 16  
**Max Channel Count:** 128 Analog, 112 Digital  
**Max Throughput:**  $\geq 50$  kHz  
**Synchronization Conditions:** Syncs with other Ethernet DI-4730, DI-4108, DI-4208, and DI-4718B models.  
 For most accurate synchronization, all instruments should be connected to the same Ethernet switch.

## Power

Power Consumption: <1.0 Watt, via USB interface

## Environmental

Operating Temperature: 0 to 50 °C  
 Operating Humidity: 0 to 90% RH non-condensing  
 Storage Temperature: -20 to 60 °C  
 Storage Humidity: 0 to 90% non-condensing

## Physical Characteristics

Enclosure: -M Version: Aluminum base with steel wrap-around. Aluminum end-panels with plastic bezels  
 Dimensions: -M Version: 5.5D  $\times$  4.25W  $\times$  1.5H in. (13.8D  $\times$  10.5W  $\times$  3.8H cm.)  
 Weight: -M Version: 14 oz.

## Software Support

WINDAQ software: OS support: View Online (<https://www.dataq.com/products/windaq/windows-compatibility/>)  
 Programming: Instrument protocol, ActiveX Control

## Ordering Information

| Description  | Order No.                |
|--|--------------------------|
| <b>DI-4208-M USB/Ethernet Data Acquisition (DAQ) System</b><br>Includes instrument, 6-ft. USB cable, 5-foot Ethernet cable, AC power adapter, screwdriver, and USB flash drive with WinDaq software.   | DI-4208-M                |
| <b>DI-4208-E USB/Ethernet Data Acquisition (DAQ) System</b><br>Includes instrument, 6-ft. USB cable, 5-foot Ethernet cable, AC power adapter, screwdriver, and USB flash drive with WinDaq software.   | DI-4208-E                |
| <b>DI-4208-M PoE Data Acquisition (DAQ) System</b><br>Includes instrument, 6-ft. USB cable, 5-foot Ethernet cable, screwdriver, and USB flash drive with WinDaq software.  | DI-4208-M-P              |
| <b>DI-4208-E PoE Data Acquisition (DAQ) System</b><br>Includes instrument, 6-ft. USB cable, 5-foot Ethernet cable, screwdriver, and USB flash drive with WinDaq software.  | DI-4208-E-P              |
| <b>250Ω 4-20 mA shunt resistor</b><br>±0.1%, 0.5 Watts max., ±50 ppm/°C  | R250                     |
| <b>MLC Flash Memory Card</b><br>Low-speed micro SD flash memory card. Recommended for recording rates under 20 kHz throughput.   | 2000351                  |
| <b>32GB High Speed Flash Memory Card</b><br>High-speed micro SD flash memory card. Recommended for recording rates higher than 50kHz throughput.   | 101014-32-HS             |
| <b>Flash Card Reader</b><br>Flash memory card reader for micro SD cards.   | 2000352                  |
| <b>WinDaq Unlock</b><br>Unlocks ChannelStretch™ to allow synchronized data acquisition and full stand-alone data logging capability where all channels can be recorded to the flash drive (without the Unlock Code only a single channel may be recorded to flash memory). | WinDaq/Unlock<br>DI-4208 |
| <b>Stand-alone Enabled</b><br>Unlocks stand-alone capability (recording all channels to USB thumb drive) and all the channels on the device (WinDaq/Unlock). AC power adapter required to run stand-alone.   | SA-Enabled-4208          |
| <b>101085</b><br>Power supply adapter (USB to AC). Required for stand-alone data logging applications. Included with DI-4208-E.  | 101085                   |
| <b>101017-RPE</b><br>European Adapter for power supply 101085.   | 101017-RPE               |
| <b>101017-RPK</b><br>UK Adapter for power supply 101085.   | 101017-RPK               |
| <b>101017-RPS</b><br>Australian Adapter for power supply 101085.   | 101017-RPS               |
| <b>101017-RPA</b><br>SPARE US Adapter for power supply 101085 (one already ships with 101085).   | 101017-RPA               |



241 Springside Drive  
 Akron, Ohio 44333  
 Phone: 330-668-1444  
 Fax: 330-666-5434

### Data Acquisition Product Links

(click on text to jump to page)

[Data Acquisition](#) | [Data Logger](#)